

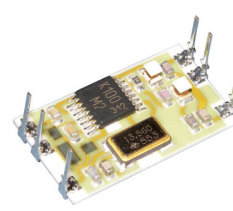

FM TRANSMITTER & RECEIVER HYBRID MODULES.

FM-RTFQ SERIES FM-RRFQ SERIES

- FM Radio Transmitter & Receivers
- Available as 315 or 433 or 868MHz
- Transmit Range up to 250m
- Miniature Packages
- Data Rate up to 9.6Kbps
- No Adjustable Components
- Very Stable Operating Frequency
- Operates from -20 to $+85^{\circ}\text{C}$



RTFQ1

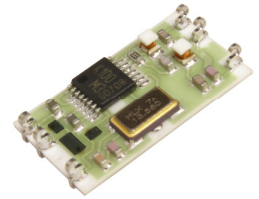

RTFQ1 SM

Transmitter

- 3-12 Supply Voltage
- SIL, DIL or SMT Packages available

Receiver

- PLL XTAL Design
- CMOS/TTL Output
- RSSI Output
- Standby Mode (max 100nA)
- 5V Supply Voltage

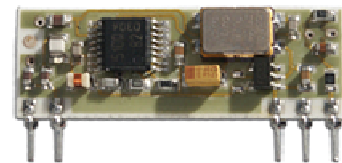

RTFQ2

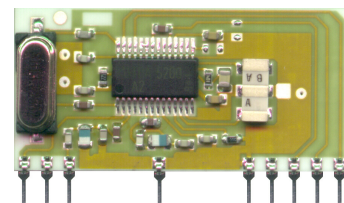

RRFQ1

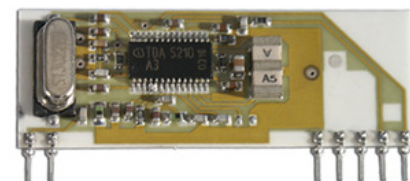

RRFQ2

Applications

- Wireless Security Systems
- Car Alarms
- Remote Gate Controls
- Remote Sensing
- Data Capture
- Sensor Reporting

Description

These miniature RF modules provide a cost effective high performance FM Radio data link, at either 315, 433.92 or 868MHz. Manufactured using laser trimmed processes on thick film ceramic substrates, the hybrid modules exhibit extremely stable electronic characteristics over an industrial temperature range. The hybrid technology uses no adjustable components ensuring very reliable operation.

This transmitter and receiver pair enables the simple implementation of a data link at distances up to 75 metres in-building and 250 metres open ground.

These modules will suit one-to-one and multi-node wireless links in applications including car and building security, EPOS and inventory tracking, remote industrial process monitoring and computer networking. Because of their small size and low power requirements both modules are ideal for use in portable, battery-powered applications such as hand-held terminals.

Transmitters

There are three versions of transmitter:

- RTFQ1; A dual in line package operating at 3.3V. This provides the most rugged mechanical fixing to the host PCB. Power down mode is also available.
- RTFQ1 SM: A dual in line surface mount package operating at 3.3V. This provides the quickest and most efficient mechanical fixing to the host PCB. Currently only available in 433MHz.
- RTFQ2; A Single in Line Package incorporating a voltage regulator for 3-12V operation. Compatible with many other RF transmitter module footprints available.

Transmitter Block Diagram

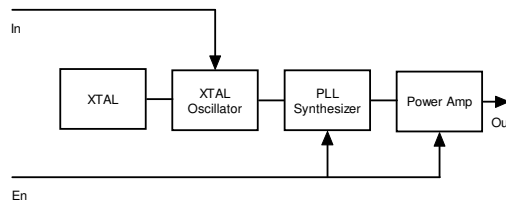

Part Numbering

| Part Number | Description |
|----------------|--|
| FM-RTFQ1-315 | DIL FM Transmitter Module 315 MHz |
| FM-RTFQ1-433 | DIL FM Transmitter Module 433.92 MHz |
| FM-RTFQ1-868 | DIL FM Transmitter Module 868.35 MHz |
| FM-RTFQ2-433R | SIL FM Transmitter Module 433.92 MHz 3-12V I/P |
| FM-RTFQ2-868R | SIL FM Transmitter Module 868.35 MHz 3-12V I/P |
| FM-RTFQ1-433SM | Surface Mount FM Transmitter 433.92 MHz |

Receivers

There are two versions of receiver:

- RRFQ1: A Single in Line Package with sleep / Power down mode.
- RRFQ2: A Single in Line Package, pin compatible with many other receivers

Receiver Block Diagram

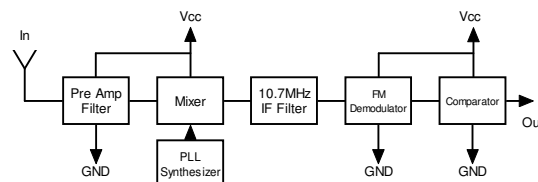

Part Numbering

| Part Number | Description |
|--------------|-----------------------------------|
| FM-RRFQ1-315 | SIL FM Receiver Module 315 MHz |
| FM-RRFQ1-433 | SIL FM Receiver Module 433.92 MHz |
| FM-RRFQ1-868 | SIL FM Receiver Module 868.35 MHz |
| FM-RRFQ2-433 | SIL FM Receiver Module 433.92 MHz |
| FM-RRFQ2-868 | SIL FM Receiver Module 868.35 MHz |

RTFQ1 Mechanical Dimensions

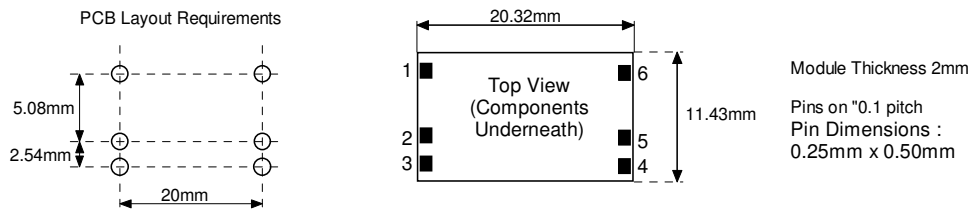

RTFQ1 SMT Dimensions

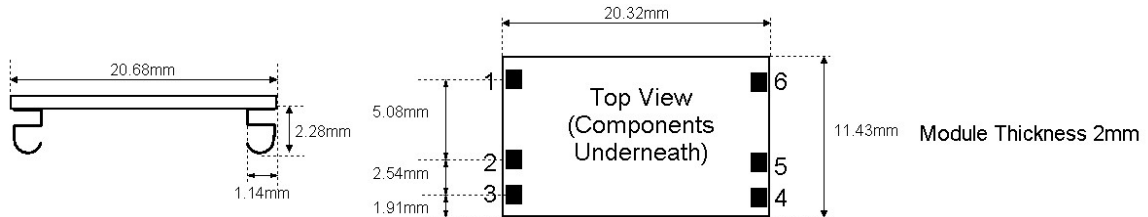

RTFQ2 Mechanical Dimensions

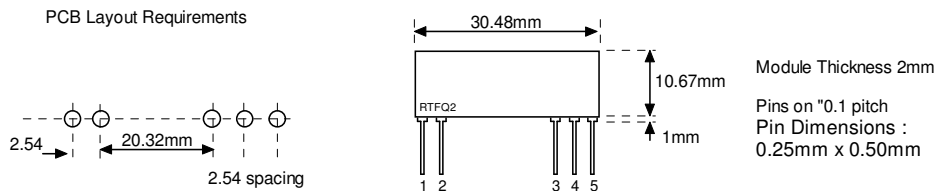

Pin Description

| RTFQ1 | RTFQ2 | Name | Description |
|-------|-------|------|---|
| 1 | N/A | En | Enable (active high) |
| 2 | 5 | IN | Data input |
| 3 | 1 | GND | Ground, Connect to RF earth return path |
| 4 | 3 | Vcc | Supply Voltage |
| 5 | 4 | GND | Ground, Connect to RF earth return path |
| 6 | 2 | EA | External Antenna |

Technical Specifications

| Electrical Characteristics | MIN | TYPICAL | MAX | DIMENSION |
|-------------------------------------|-----|---------------------------|-------|-----------|
| Supply Voltage RTFQ1 | 2.1 | 3.3 | 4.00 | V |
| Supply Voltage RTFQ2 | 2.5 | | 12.00 | V |
| Supply Current | | 7 | 8 | mA |
| Standby Current (IN = EN = Low) | | | 100 | nA |
| Frequency | | 315.0 433.92 868.35 | | MHz |
| RF Output into 50Ω (Vcc=3.3V) | | +5 / +5 / +1 | | dBm |
| Initial Frequency Accuracy | -35 | 0 | +35 | KHz |
| FM Deviation | 25 | 30 | 35 | KHz |
| Harmonic Spurious Emissions | | -50 | | dBc |
| Input High Voltage RTFQ1 | 1.5 | | Vcc | V |
| Input High Voltage RTFQ2 | 1.5 | | 5.5 | V |
| Power up Time (En to full RF) | | | 1 | mS |
| Power up Time (Power on to full RF) | | | 5 | mS |
| Max Data Rate | | | 9.6 | KHz |
| Operating Temperature | -25 | | +80 | °C |

RRFQ1 Mechanical Details

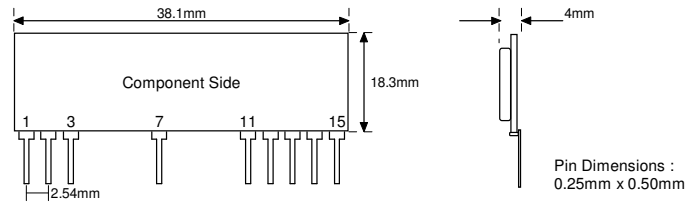

RRFQ2 Mechanical Details

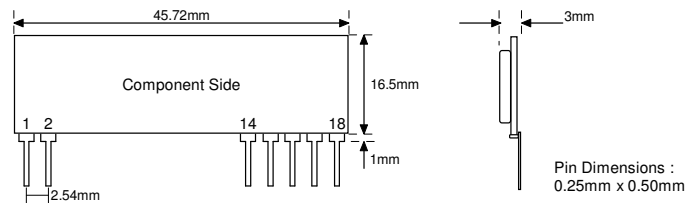

Pin Description

| RRFQ1 | RRFQ2 | Pin Description |
|----------|-------|--|
| 1 | 16 | +Vcc |
| 2, 7, 11 | 2, 15 | GND |
| 3 | 1 | Data In (Antenna) |
| 12 | | NC |
| 13 | 14 | Received Signal Strength Output |
| N/A | 17 | AF Output |
| 14 | 18 | Data Out |
| 15 | N/A | Power Down 0V = Standby 5V = Operating |

RSSI Output*

| RF In (dBm) | RSSI (V) |
|-------------|----------|
| -120 | 1.20 |
| -110 | 1.32 |
| -100 | 1.50 |
| -90 | 1.78 |
| -80 | 2.06 |
| -70 | 2.35 |
| -60 | 2.62 |
| -50 | 2.72 |
| -40 | 2.75 |

RSSI Output

The RSSI provides a DC Voltage proportional to the peak value of the receive data signal. This output can be used as an indicator for the received signal strength to use in wake-up circuits etc.

An RC circuit is normally used to provide the timing for the RSSI signal. The modules have a 10nF capacitor internally connected to GND, therefore a pull down resistor (to GND) connected to the RSSI pin may be used to generate a simple RC network time constant for the RSSI signal output.

Please note that the maximum output current is typically 950µA, the discharge current is lower than 2µA

Technical Specifications

| Electrical Characteristics | Min | Typical | Max | Dimension | Notes |
|--|------------|----------------------------|----------------|-----------|-----------|
| Supply Voltage (Vcc) | 4.5 | 5 | 5.5 | V | |
| Supply Current (Operating) | | 5.7 | 6.8 | mA | |
| Supply Current (Standby) | | | 100 | nA | |
| Receiver Frequency | | 315.00 433.92 868.35 | | MHz | |
| R.F Sensitivity (100% AM) 315 ,433MHZ versions 868MHz versions | | -103 -100 | | dBm | |
| 3dB Bandwidth | | +/-150 | | KHz | |
| Data Rate RRFQ1 RRFQ2 | 300 300 | | 9,600 4,800 | Hz | |
| Turn on Time | | | 5 | mSecs | 1 |
| Turn on Time | | 8 | | mSecs | 2 |
| Level of Emitted Spectrum | | | -70 | dBm | |
| Low Level Output Voltage | | | 0.8 | V | I = 200uA |
| High Level Output Voltage | Vcc-1 | | | V | I = 200uA |
| RSSI Output | | 0.95 | | mA | |
| Operating Temperature Range | -25 | | +80 | °C | |

Notes

1. Time from PD pin going high to stable data. (RRFQ1 only)
2. Time from Power ON to stable data.

Prototyping Hints

It is essential when building any Low Power Radio System that you have a 'clean' DC power source. Typically the ripple voltage should be less than 10mV Peak to Peak. Normally a 470uF decoupling capacitor is sufficient de-coupling for an AC derived DC power source. Small capacitors of 10-100nF can also be used across the power supply to filter high frequency noise.

Never place a Transmitter or Receiver directly into Vero-Board or any similar prototyping board. This will severely restrict the range. Rather, use small lengths of wire from the prototyping board to the pins of the Transmitter or Receiver.

A useful antenna, for testing purposes, for both the Transmitter and Receiver on 433MHz is to use a piece of wire 17.3cm long (23.8cm at 315MHz) soldered directly to the antenna pin.

Data should be encoded before it is transmitted over a wireless link to ensure reliability and reduce the effect of interference and cross talk. A range of encoders IC's are available from RF Solutions, please refer to the RF Solutions website for further information.

Typical Application

The following circuits show a remote control system with 'self learning feature'. Please refer to datasheet DS600 for more information.

Transmitter Circuit

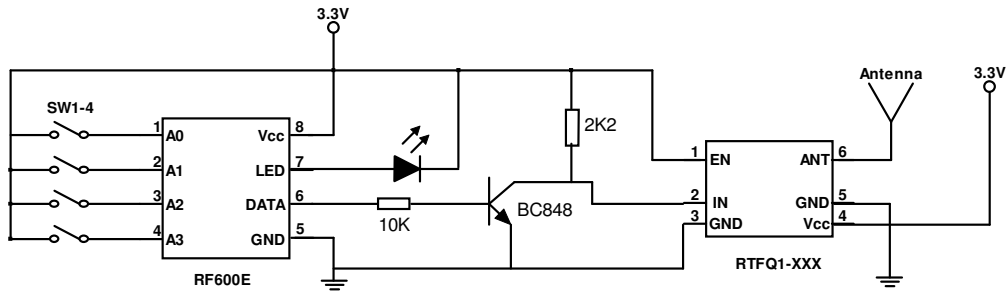

Receiver Circuit

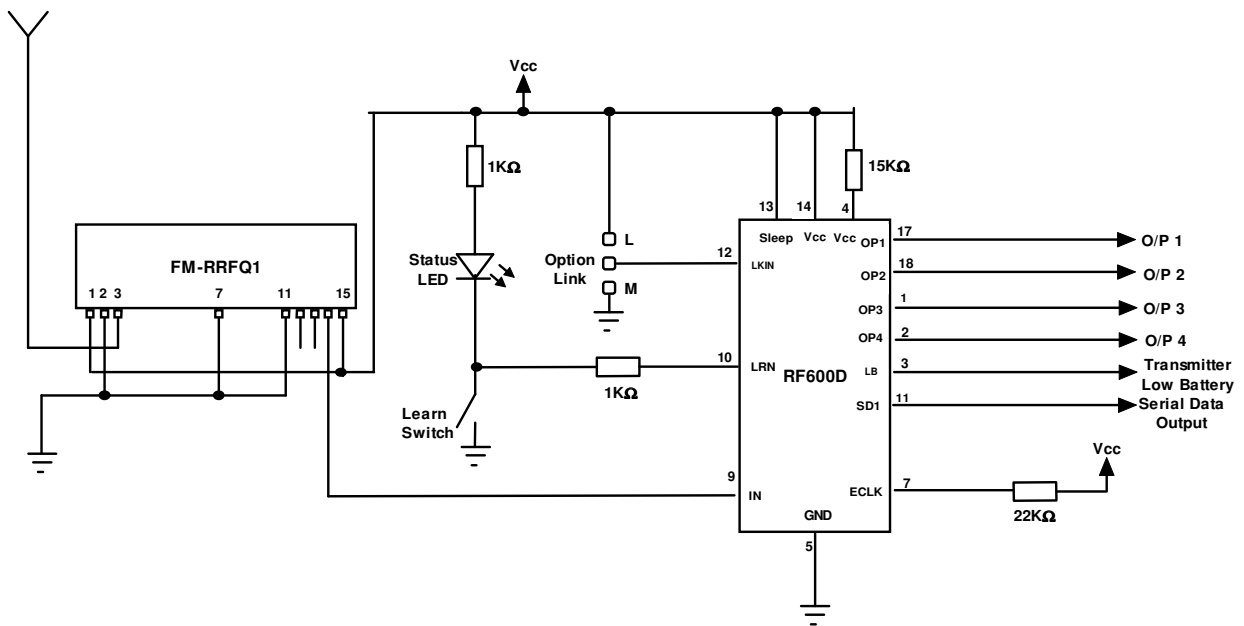

For more information or general enquiries, please contact:

RF Solutions Ltd.,
Unit 21, Cliffe Industrial Estate,
South Street, Lewes, E Sussex, BN8 6JL. England
Tel +44 (0)1273 898 000 Fax +44 (0)1273 480 661

Email: sales@rfsolutions.co.uk

<http://www.rfsolutions.co.uk>

RF Solutions is a member of the Low Power Radio Association
 All Trademarks acknowledged and remain the property of the respected owners

Information contained in this document is believed to be accurate, however no representation or warranty is given and R.F. Solutions Ltd. assumes no liability with respect to the accuracy of such information. Use of R.F.Solutions as critical components in life support systems is not authorised except with express written approval from R.F.Solutions Ltd.