

NEW

Radiometrix

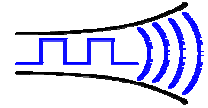

Hartcran House, 231 Kenton Lane, Harrow, HA3 8RP, England

01 November 2004

Tel: +44 (0) 20 8909 9595, Fax: +44 (0) 20 8909 2233

SPM2-433

UHF SpacePort Modem

The SpacePort Modem (SPM) is a low cost highly integrated intelligent radio packet modem that enables a radio network/link to be simply implemented between a number of digital devices. The SPM uses addressable data packets with error checking, packet acknowledgements and retransmissions to achieve a reliable invisible wireless data link. Built for ease of use and rapid installation, the serial interface ensures direct connection to microprocessors or to RS232 port via RS232 driver while remote configuration enables post installation setup of the modem.

Features

- ◆ Addressable point-to-point
- ◆ Point-to-Multipoint and broadcast modes
- ◆ Inverted RS232 interface at TTL level
- ◆ DTE speed 600-115200bps
- ◆ Air data speed 1200-14400bps
- ◆ Single 5V or 3.3V supply
- ◆ Flow control - Hardware, None
- ◆ Up to 200m outdoor & 50m in-door range
- ◆ Built-in command line configuration
- ◆ Built-in RF link diagnostics
- ◆ Remote over-air unit configuration
- ◆ Low operating current, Auto standby mode
- ◆ Conforms to ETSI EN 300 220-3 and EN 301 489-3
- ◆ Dimensions - 23mm X 39mm X 6.5mm



SPM2-433-28

Applications

- ◆ PDAs, organisers & laptops
- ◆ Telemetry and telecontrol
- ◆ Handheld / portable terminals
- ◆ EPOS equipment, barcode scanners, belt clip printers, stock control, job allocation
- ◆ Remote data acquisition system, data loggers
- ◆ Audience response systems
- ◆ In-building, environmental monitoring and control systems
- ◆ High-end security and alarm signalling
- ◆ Restaurant ordering systems
- ◆ Fleet management, vehicle data acquisition

INTRODUCTION

The *SPM2* is a self-contained radio packet modem module that requires only a simple antenna, 5V supply and a serial I/O port on a host microcontroller or PC.

The module provides all the RF circuits and processor intensive low level packet formatting and packet recovery functions required to inter-connect any number of devices with serial port in a radio network.

A continuous stream of serial data downloaded by a Host microcontroller into the *SPM* serial receive buffer is transmitted by the *SPM's* transceiver and will "appear" in the serial buffer of the addressed *SPM* within radio range.

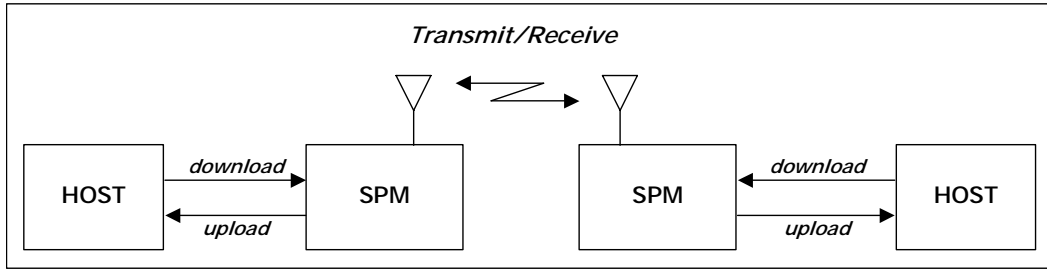

Figure 1: SPM + Host -controller

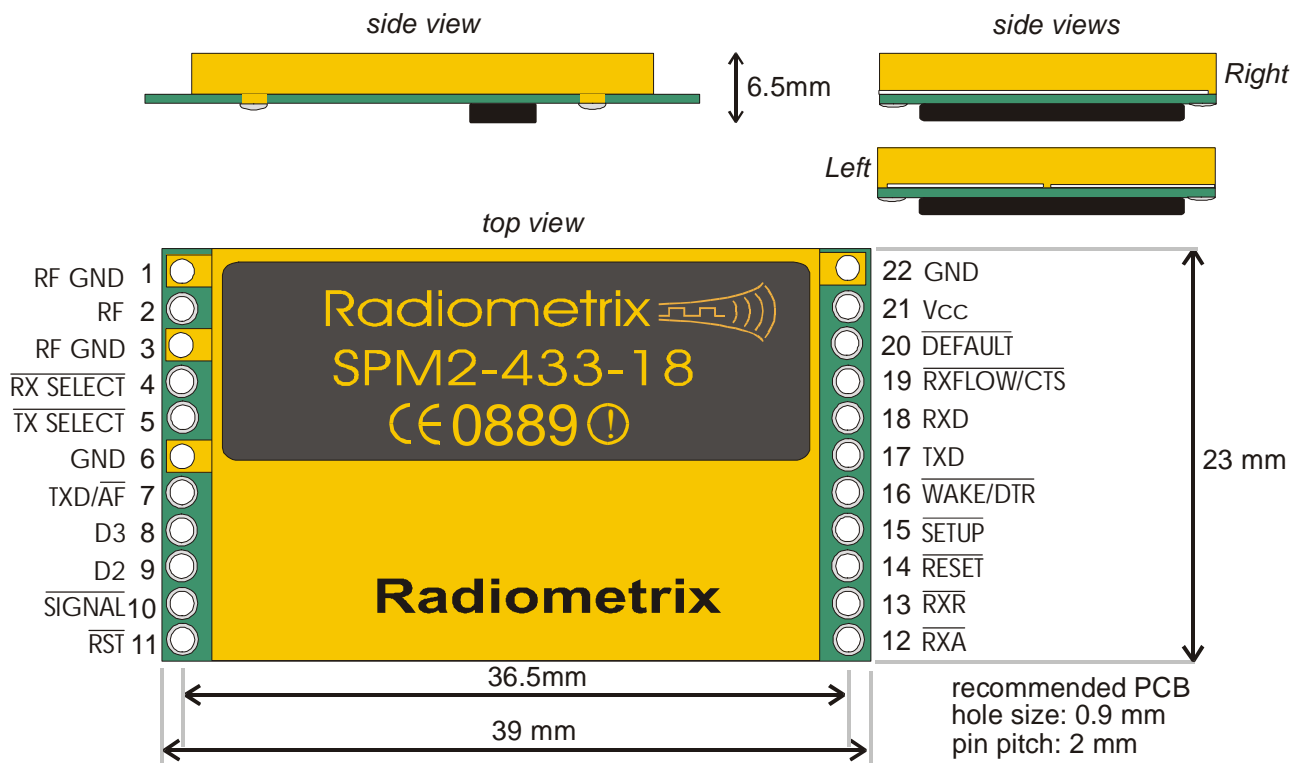

Figure 2: Physical dimensions and pinouts

TECHNICAL SPECIFICATION

General

Operating Voltage

5VDC

Operating Current

Transmitting/Receiving
Standby/Power-down

Average 40mA (Data streaming)
15mA/400µA

Operating frequency

Single channel 433.920 MHz
To be released on 869.85MHz and 914.50MHz

Operating Temperature

-10°C to +55°C

Configuring options

Built-in command line configurator

Interface

Serial Interface

Inverted RS232 at TTL level

Serial Protocol

8 data/1 stop/no parity

Serial Signals

RXD, TXD, CTS, WAKE

Power down Control

Via WAKE signal

Serial Handshaking

Selectable as CTS signal or none

DTE Interface Speed

600/1200/2400/4800/9600/14400

19200/38400/57600/115200 bps

Air Interface Speed

1200/2400/14400 bps

Overall throughput – Acknowledged

18kbps (max) for standard and 28kbps for fast variant

– Unacknowledged

30kbps (max) for standard and 55kbps for fast variant

Receiver

Sensitivity

-95 dBm for 1ppm BER and -90dBm for fast variant

LO leakage (conducted)

-70dBm

Transmitter

Output Power

10mW ERP

2nd harmonics

-46 dB

Approval

European Standards

ETSI EN 300-220-3 (radio) and ETSI EN 301 489-3 (EMC)

1. FUNCTIONAL DESCRIPTION

The *SPM* is a connection oriented modem module for sending and receiving serial data via an RF communications link.

The *SPM* handles all necessary protocol related functions of validation and retries to ensure error free and uninterrupted data is sent over the communications link. All data transfers between a pair of *SPMS* are fully acknowledged, thus preventing the loss of data. Bit coding and checksums are used on the data packets to ensure the validity of the received data at the remote end.

1.1 OPERATING STATES

The *SPACEPORT* Modem has three normal operating states:

- *SHUTDOWN*
- *STANDBY*
- *CONNECTED*

SHUTDOWN

The *SHUTDOWN* state is entered by asserting the WAKE/DTR input pin high (Vcc). It effectively forces the *SPM* into a suspended state. Communications cannot be made with the *SPM* in this state.

STANDBY

Immediately after power up and during normal operation, the *SPM* will automatically enter standby mode where it is waiting for a connection request from a remote *SPM* module.

While in this mode a remote connection request can be received which will place the *SPM* into a connected state allowing it to then start receiving data from the remote unit. The connected host device can also send data to the *SPM* via the serial interface which will force the module to send a connection request to the remote *SPM* module, thus effectively setting up a logical connection between two units and allowing data to be transferred.

CONNECTED

On receipt of a connection request from a remote unit, the *SPM* immediately enters a connected state. This effectively allows the *SPM* modems to start sending and receiving data.

In-coming data is sent to the host via the serial port in the same form as it was given to the remote *SPM* module.

2 THE HOST INTERFACE

2.1 SIGNALS

The connection to the SPM is a full duplex serial interface supporting baud rates from 600bps to 115200bps. Additional control signals are provided to assist in flow control, configuration and power saving in the SPM. Figure 3 shows an overview of the interface signals to the SPM.

Pin name	Pin	Pin Function	In/Out	Description
RF GND	1, 3	RF signal ground		BNC casing/coax braid connection
RF	2	RF signal	Input or Output	Antenna pin/coax core connection
$\overline{\text{RXSELECT}}$	4	Receiver Select	Input or Output	Manual RF Receiver Enable or RF Receiver Active Indicator
$\overline{\text{TX SELECT}}$	5	Transmitter Select	Input or Output	Manual RF Transmitter Enable or RF Transmitter Active Indicator
$\overline{\text{TXD/AF}}$	7	Transmitted Data or demodulated signal	Input or Output	Transmitted Packetised Data to BiM2 Analogue Demodulated signal from BiM2
D3	8	SP2 Data line	NC	Internal data line between RPM and FRPC
D2	9	SP2 Data line	NC	Internal data line between RPM and FRPC
$\overline{\text{SIGNAL}}$	10	Preamble Detect	Output	Valid preamble indicator
$\overline{\text{RST}}$	11	FRPC reset	NC	Resets FRPC which also isolates BiM2
$\overline{\text{RXA}}$	12	Receive Acknowledge	NC	Host to FRPC download request acknowledge
$\overline{\text{RXR}}$	13	Receive Request	Output	Valid Data packet indicator
$\overline{\text{RESET}}$	14	Reset	Input	Hardware reset of the SPM
$\overline{\text{SETUP}}$	15	Enter Setup	Input	Enter SPM configurator after a reset
$\overline{\text{WAKE/DTR}}$	16	Wake or Shutdown	Input	Wakes SPM when low, shuts down when high
TXD	17	Serial transmitted data	Input	Host (DTE) to SPM serial data
RXD	18	Serial Received data	Output	SPM to host (DTE) serial data
$\overline{\text{CTS}}$	19	Flow control	Output	SPM to Host (DTE) flow control
$\overline{\text{DEFAULT}}$	20	Force 9600bps	Input	Force the SPM serial interface to 9600bps
VCC	21	Vcc Supply	Input	+5VDC
GND	6, 22	Ground	-	Ground internally connected to RF GND

- notes:**
1. RXD/TXD lines are true data
 2. The 4 input control lines are active low
 3. Logic levels are 5V CMOS. See electrical specifications
 4. Input control pins must be terminated, as pull-ups are not provided
 5. Indicator outputs are active low which can be connected to LEDs

2.2 SPACEPORT RESET

RESET

The Reset signal may either be driven by the host (recommended) or pulled up to Vcc via a suitable resistor (10k Ω). A reset aborts any transfers in progress and restarts the SPM.

HOST DRIVEN RESET

Minimum low time: 1.0 μs , after reset is released (returned high). The host should allow a delay 1ms after reset for the SPM to initialise itself.

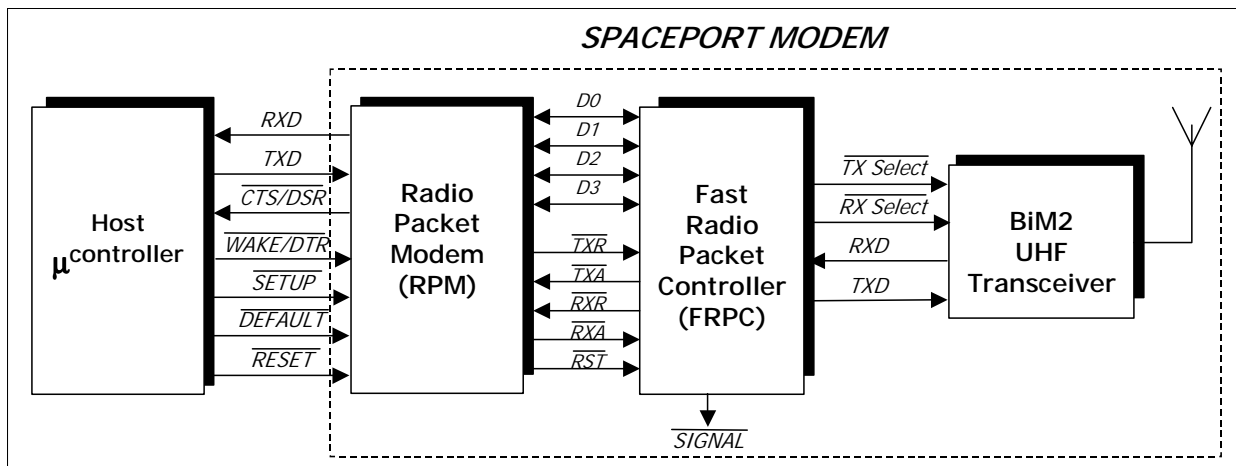

Figure 3: Host to SPM connection

2.3 HOST TO SPACEPORT DATA TRANSFER

Data is transferred between the SPM and the *HOST* using an asynchronous serial protocol. The default protocol settings are 8 data bits, no parity and 1 stop bit (8n1). The baud rate setting for the serial interface is user settable from 600bps to 115200bps.

TXD

Data from the connected host is received by the SPM using *TXD* signal.

CTS

A single handshake line, *CTS*, controls the flow of data into the SPM. The serial receive buffer of the SPM is 96 bytes deep. The *CTS* will be asserted by the SPM when the receive buffer hits approximately 66% full. It is advisable to limit the number of characters sent to the SPM after the *CTS* control line is asserted. This will help to reduce the possibility of lost data due to internal buffer overruns in the SPM. The SPM will clear the *CTS* when the internal serial receive buffer falls below 33% full.

RXD

Upon the SPM receiving data from a remote unit, the received data is sent to the connected host device using the *RXD* signal.

2.4 ENTERING SPACEPORT MODEM CONFIGURATOR

Configuring the SPM is accomplished by using a built-in command line configurator. The configurator is entered by asserting the *SETUP* input of the SPM while resetting the SPM.

SETUP

Holding *SETUP* low during a reset cycle will force the modem into the configurator. The state of this input is checked while the SPM starts up from either power on or reset.

HOST DRIVEN SETUP

The Setup pin may either be driven by the host (recommended) to enable host controlled configuration of the SPM or pulled up to VCC via a suitable resistor (10k Ω).

2.5 FORCING DEFAULT SERIAL BAUD RATE

Asserting this pin low forces the SPM to startup with a default baud rate of 9600bps, 8 data, one stop and not parity.

DEFAULT

During a *RESET* the *HOST* must hold *DEFAULT* low to force the SPM serial interface to default to 9600bps. This is ideal if the serial baud rate has been forgotten or incorrectly set.

HOST DRIVEN DEFAULT

The *DEFAULT* pin may either be driven by the host (recommended) or pulled up to VCC via a suitable resistor (10k Ω).

2.6 FORCING SPACE MODEM IN TO SLEEP MODE

Asserting the *WAKE* input high forces the modem into a low power sleep mode. This effectively shuts down the SPM and prevents it from sending or receiving any data. It is a method for conserving power when the modem is not required.

WAKE / DTR

During normal operation *WAKE* pin can be pulled high to force the SPM to shutdown into low power sleep mode.

HOST DRIVEN WAKE

The *WAKE* pin may either be driven by the host (recommended) or pulled up to 0V via a suitable resistor (10k Ω).

3.0 SPACEPORT CONFIGURATION

3.1 ENTERING THE CONFIGURATOR

The SPM is configured by entering the built-in software configurator. Current argument can be displayed by entering parameter / command without argument

3.2 USER CONFIGURABLE PARAMETERS

CONFIG	Display a list of the current SPM configuration. This will also set <i>FLOW</i> control to none to enable simple 3 wire communication
Valid range	None
DEFAULT	Set all SPM configuration settings to their factory default values.
Valid range	None
RESET	Exit the modem and force a software reset. Any changed parameters will take effect after the modem has restarted. When exiting the configurator, the <i>HOST</i> device must ensure the <i>SETUP</i> pin is high otherwise the configurator will be re-entered after the reset.
Valid range	None
UNIT	Sets the unit number. Two SPM modules can communicate with each other provided they have matching Unit numbers and Site codes.
default	0
Valid range	0 to 15
SITE	Sets the Site address The site number is used to distinguish between groups of operating modems. The site code is an address extension to the unit number.
default	0
valid range	0 to 7
ADDR	Updates the unit number value. This command is used for changing the unit number without updating the stored value. This enables the <i>SPACEPORT</i> to support point-to-multipoint communications. Upon using this command the configurator is exited and the modem operation is resumed. The modem is not reset when the configurator is exited.
Valid range	0 to 15
BAUD	Sets the host interface baud rate. The changed baud rate will take effect after resetting the SPM.
default	9600
valid range	600, 1200, 2400, 4800, 9600, 19200, 38400, 57600, 115200
THRUPUT	Sets the on-air data throughput. Three possible settings are provided. max: sets the maximum data throughput of the SPM. slots: effectively reduces the on-air throughput. This opens up 'time slots' allowing other SPM pairs, operating within close proximity, equal opportunity to transmit data. fcc: sets the on-air throughput to a rate which is compatible with <i>FCC</i> regulations (max 10% air time) for use in the US.
default	max
valid range	max, slots, fcc

FLOW	<p>Sets the serial flow control between the host and SPACEPORT.</p> <p>Using no flow control enables the SPM to be used with a 3 wire serial link (TXD, RXD, GND). Care must be taken in order to prevent overflowing the 96 byte serial receive buffer in the SPM. Using hardware flow control enables the SPM to control the flow of serial data being received.</p>
default	hw
valid range	hw, none
SERDLY	<p>Sets the serial data receive to packet transmit delay.</p> <p>When the SPM receives the first byte of data from the host, it starts a timer running. Either a full buffer of data to send or a timeout of this timer will allow the packet to be transmitted. Fine tuning this delay for the baud rate the SPM is operating at can significantly increase throughput while reducing unnecessary transmissions.</p>
default	2 (x10ms)
valid range	2 to 255 (x10ms)
SHDN	<p>Sets the action of the WAKE input.</p> <p>Setting shutdown to <i>ON</i> will cause the SPM to monitor the <i>WAKE</i> input. When <i>WAKE</i> is taken high the SPM will be forced into low power sleep mode, thus reducing current consumption. Subsequently lowering the <i>WAKE</i> input will bring the SPM out of low power sleep mode.</p>
default	On
valid range	on, off
RETRY	<p>Sets the number of data retry attempts.</p> <p>RF interference can cause a transmitted data packet to be lost or corrupt on reception. If this happens the SPM will retransmit any unacknowledged transfer. The transmission will be retried the specified number of times before the link to the remote unit is considered 'lost' and the data purged.</p>
default	5
valid range	1 to 63
STRMSG	<p>Enables the startup message.</p> <p>The startup message is enabled by default, thus giving an immediate indication of the operation of the SPM. The message can be disabled prior to deployment of the SPM module.</p>
default	On
valid range	on, off
ACKMODE	<p>Enables transfer acknowledgements.</p> <p>This function enables packet transfer acknowledgements to be returned for every outgoing packet. Packet acknowledgements aid in the delivery of error free and consistent data transfers between a pair of modems. Disabling the acknowledgements results in higher data throughput between modems, but does not protect against lost data due to RF interference. It should be disabled while using SPM in a broadcast mode.</p>
default	On
valid range	on, off
REMOTE	<p>Enables remote configuration.</p> <p>Over-air remote configuration of a SPM module is possible once it has been enabled. The remote command is used to send remote configuration commands. See the following chapter for an overview of remotely configuring a SPM module.</p>
default	On
valid range	on, off

RADAR Starts the radar test.
Used as a range or confidence test between SPM modules within the same *site*.
parameter Unit number between 0 and 15.

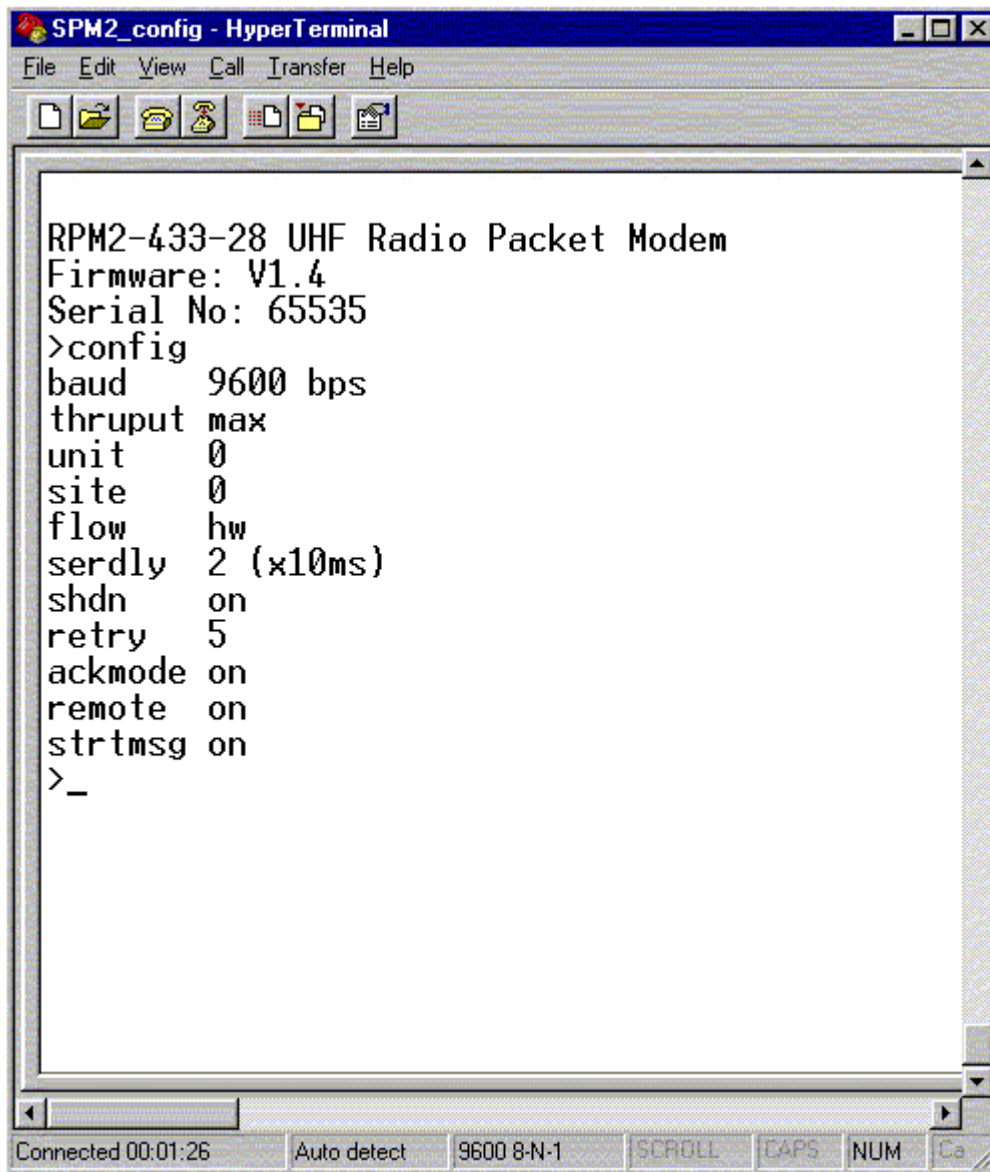

Figure 4: SPM2 configuration using HyperTerminal

Note: To configure the SPM the HyperTerminal should be set with the following settings. Hardware flow control should be disabled. Default baud rate of the SPM is 9600bps. However if the default baud rate of the SPM is changed then the baud rate of the HyperTerminal should be matched or DEFAULT jumper should be connected to force the SPM baud rate to 9600bps.

4.0 EXTENDED SPACEPORT FEATURES

4.1 THROUGHPUT

The SPM supports two rates, *MAX* and *SLOTS*, of over-air throughput. A third rate is also provided which can be used during normal operation, but is specifically supplied for compliance with FCC regulations.

MAX: When set to *MAXimum* and streaming data at the SPM, the data is sent as quick as possible. For host baud rates of 19200 and above, data is transmitted continuously with minimal delay between sequential packets. When this occurs, there is effectively no airtime for another pair, operating in close proximity, to transmit without causing collisions. The maximum over-air throughput that can be achieved is 14400bps.

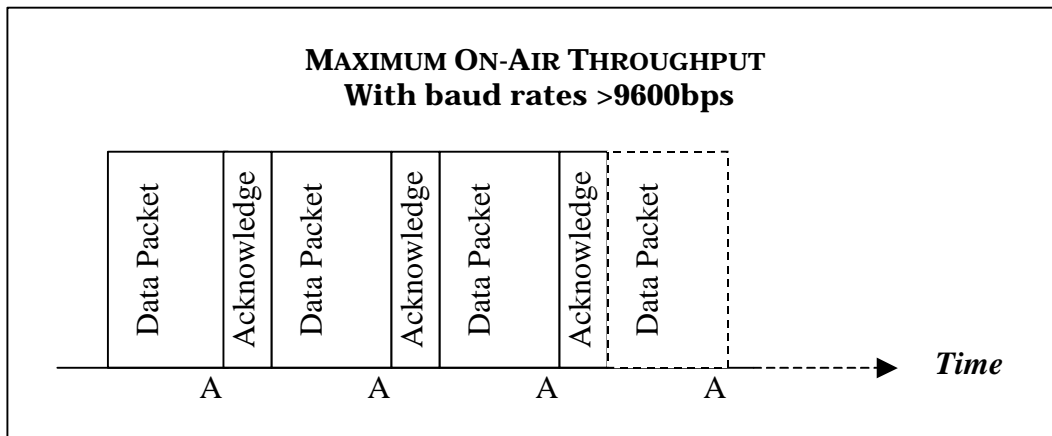

Figure 5: A *SPACEPORT MODEM* pair streaming at maximum throughput

SLOTS: Setting the throughput to *SLOTS* provides a method of opening 'time slots' for other SPM pairs operating in close proximity. The effective streaming on-air throughput between a pair of SPM is effectively reduced to approximately 2400bps.

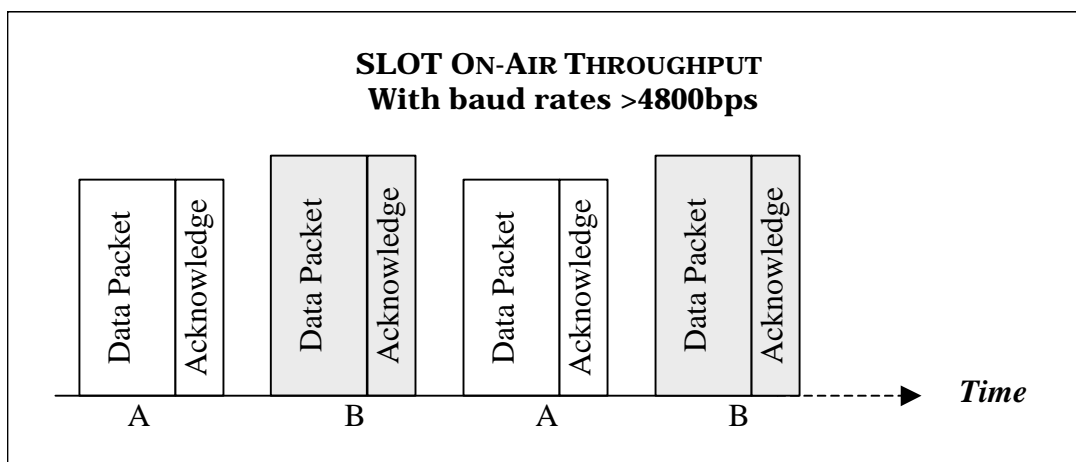

Figure 6: Two *SpacePort Modem* pairs operating Slot throughput

FCC: This setting is effectively the same as *SLOTS*, however it further slows the over-air throughput to approximately 1200bps. This mode is provided to enforce the modem to comply with FCC regulations of 10% maximum airtime usage. The *THRUPUT* should be set to *FCC* for all SPM modules used in all equipment subject to FCC regulations.

4.2 REMOTE CONFIGURATION

Remote configuration of a SPM module is possible using the *REMOTE* command from within the configurator. The remote SPM unit should be on or in auto-standby mode.

Initially the *REMOTE* command is used to enable and disable the ability to remotely configure a module, as described in section 3.2: User Configurable Command.

Once remote configuration is enabled the *REMOTE* command is then used to issue configuration commands to a remote SPM. The format for the remote command then becomes:

```
REMOTE <SERIAL NUM> <COMMAND> <PARAMTER>
```

The <*SERIAL NUMBER*> of the remote SPM must be known in order for the remote configuration request to be executed on the appropriate SPM module.

The <*COMMAND*> to be executed can be any of the following:

Baud 600,1200,2400,4800,9600,19200,38400,57600,115200

Unit 0 to 15

Site 0 to 7

Shdn on/off

Flow hw/none

Serdly 2 to 255

Retry 1 to 63

Strtmsg on/off

The <*PARAMETER*> is optional, and if not specified the setting for that command is returned and displayed.

4.3 POINT-TO-MULTIPOINT

The *SPM* can be used for point-to-multipoint communications. One module must be considered to be the master, which is used to address up to 15 remote units in any one site.

During normal operation, the base unit can be set to address another unit dynamically by entering the configurator and using the *ADDR* command to change the unit address. Upon execution of this command, provided the parameters are correct, the configurator is exited immediately. A period (".") is sent to the connected host device to indicate that the change has been registered and the SPM is now ready for communications to the new unit address.

ADDR is very similar to the *Unit* command, except that *ADDR* does not update the stored EEPROM unit value. As the EEPROM has a limited number of write cycles, using *ADDR* for addressing multiple units in a point to multipoint network is recommended. Also, the *ADDR* command will exit the configurator immediately, which is required to resume communications very quickly.

4.4 BROADCAST MULTIDROP

The SPM has a broadcast mutidrop mode which provides a mechanism for building a large networks. This mode of operation is determined by the configuration command keyword *ACKMODE* being set to **OFF**.

In broadcast mutidrop mode, the SPM does not implement network layer functionality related to data packet routing, acknowledgement and retries. The connected host device should provide network layer functionality.

The site code and unit address is still used by the radio modem when working in broadcast multidrop mode. For a given multipoint network all radio modems within a group must contain the same site code and unit address.

4.5 RADAR: DIAGNOSTIC TEST

Built into the configurator is a diagnostic test suitable for range testing and link confidence testing. The Radar test effectively sends a small request packet to a remote unit then waits for a reply. The remote unit must not be in the configurator otherwise it will not respond.

Upon receipt of a positive response from the remote unit, a success is recorded before the process is repeated. This test will continue indefinitely until it is ended by a key press.

4.6 SpacePort Modem Error Handling

The SPM's radio decoder module is deliberately non bit error tolerant, i.e. no attempt is made to repair corrupt data bits. All of the redundancy in the code is directed towards error checking. For an FM radio link using short packet lengths, packets are either 100% or so grossly corrupt as to be unrecoverable. By the same reasoning, the Host is not informed or sent corrupt data since corrupt information is of little value. The SPM implements packet acknowledges, timeouts and re-transmission to accomplish reliable error handling.

Ordering information

Part number	Throughput	Sensitivity	Supply
SPM2-433-18	18kbps	-95dBm	5V
SPM2-433-18-3V	18kbps	-90dBm	3.3V
SPM2-433-28	30kbps	-90dBm	5V

Appendix A

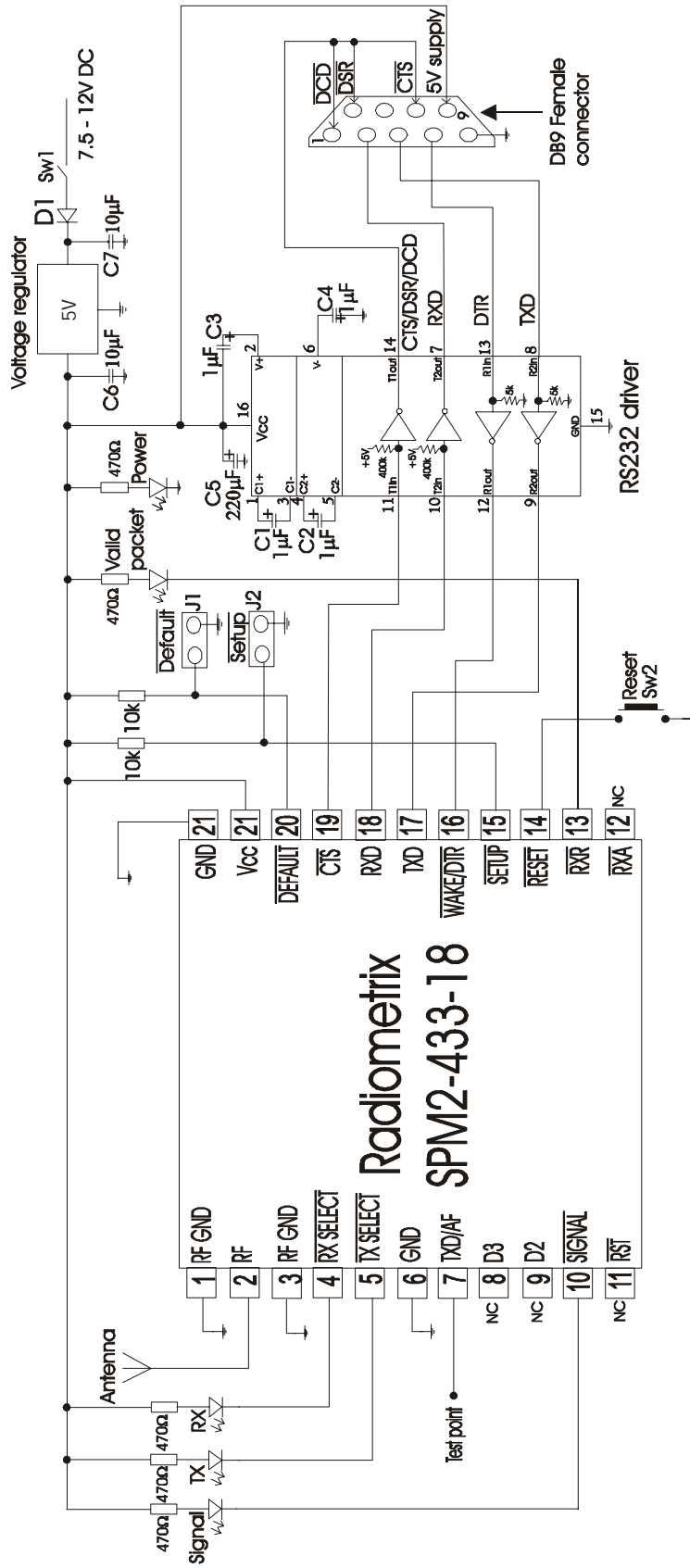

Figure 7: Example circuit to make radio modem with DCE type RS232 interface

Appendix B

Fast Radio Packet Controller (FRPC)

Package type: 18-Lead Plastic Surface Mount
(SOIC - 300mil wide body)

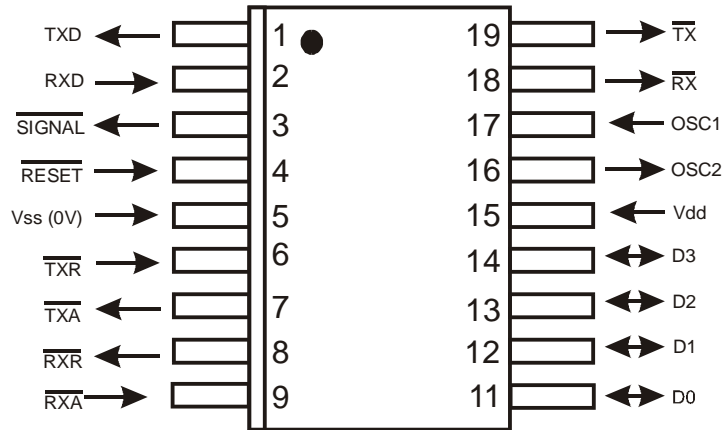

Figure 8

Radio Packet Modem (RPM)

Package type: 28-Lead Plastic Surface Mount
(SOIC - 300mm wide body)

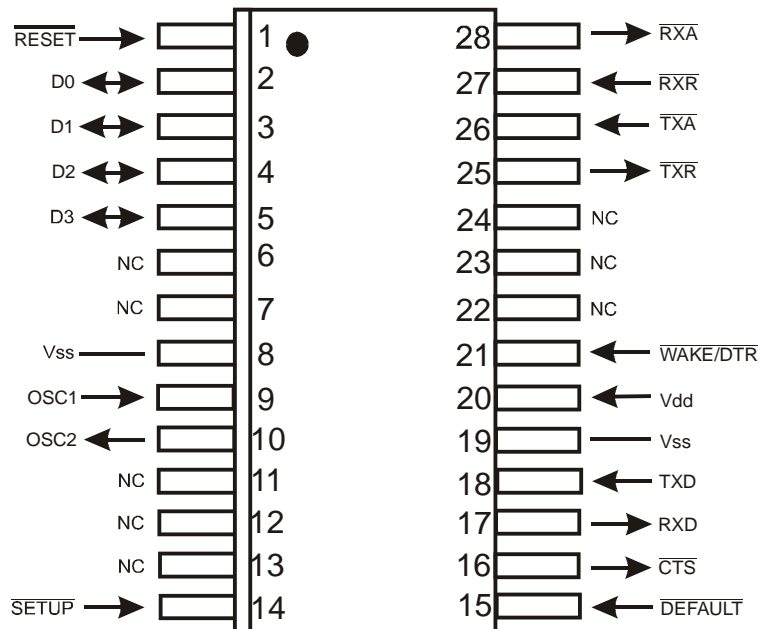

Figure 9

Radiometrix Ltd

**Hartcran House
231 Kenton Lane
Harrow, Middlesex
HA3 8RP
ENGLAND
Tel: +44 (0) 20 8909 9595
Fax: +44 (0) 20 8909 2233
sales@radiometrix.com
www.radiometrix.com**

Copyright notice

This product data sheet is the original work and copyrighted property of Radiometrix Ltd. Reproduction in whole or in part must give clear acknowledgement to the copyright owner.

Limitation of liability

The information furnished by Radiometrix Ltd is believed to be accurate and reliable. Radiometrix Ltd reserves the right to make changes or improvements in the design, specification or manufacture of its subassembly products without notice. Radiometrix Ltd does not assume any liability arising from the application or use of any product or circuit described herein, nor for any infringements of patents or other rights of third parties which may result from the use of its products. This data sheet neither states nor implies warranty of any kind, including fitness for any particular application. These radio devices may be subject to radio interference and may not function as intended if interference is present. We do NOT recommend their use for life critical applications. The Intrastat commodity code for all our modules is: 8542 6000.

R&TTE Directive

After 7 April 2001 the manufacturer can only place finished product on the market under the provisions of the R&TTE Directive. Equipment within the scope of the R&TTE Directive may demonstrate compliance to the essential requirements specified in Article 3 of the Directive, as appropriate to the particular equipment.

Further details are available on The Office of Communications (Ofcom) web site:

http://www.ofcom.org.uk/licensing_numbering/radiocomms/licensing/licensing_policy_manual/

Information Requests

Ofcom

Riverside House

2a Southwark Bridge Road

London SE1 9HA

Tel: +44 (0)845 456 3000 or 020 7981 3040

Fax: +44 (0)20 7783 4033

information.requests@ofcom.org.uk

European Radiocommunications Office (ERO)

Peblingehus

Nansensgade 19

DK 1366 Copenhagen

Tel. +45 33896300

Fax +45 33896330

ero@ero.dk

www.ero.dk
