

TCM8230MD (A)

TENTATIVE

VGA CAMERA MODULE

The TCM8230MD(A) is a camera module which includes area color image sensor embedded with camera signal processor that meets with VGA format. In the sensor area 492 vertical and 660 horizontal signal pixels, and the image size meets with 1/6 inch optical Format. Use of the CMOS process enables low power consumption operations. It also provides excellent color reproduction through its primary color filter, and embedded camera signal processor enables small and simple camera system. And this module can be assembled by the socket which is suitable for the reflow soldering. So it is fit to use as an image input device for digital still cameras, PC cameras and mobile devices.

Features

1. General

- Module size : 6(W) x 6(D) x 4.5(H) mm
- I²C BUS I/F
- Sleep mode operation (It can be controlled by the I²C Bus command)
- Power supply : 2.8+/-0.2V or 2.5+/-0.2V (Sensor(photo diode), I/O) and 1.5+/-0.1V(Sensor(A/D converter), Digital)

2. Sensor

- Optical size : 1/6 inch optical format
- Total pixel numbers : 698(H)x502(V)
- Signal pixel numbers : 660(H)x492(V)
- Pixel pitch : 3.75um(H)x3.75um(V) (square pixel)
- Color filter : RGB color filter, Bayer arrangement (GR line and GB line are arranged alternately.)
- Frame rate : Max 30fps
- Raw data bit precision : 10bit
- Feed back clamp

3. Camera signal processing

- Maximum exposure time can be adjust from 1V to 15V
- Digital outputs
YUV=4:2:2 or RGB=5:6:5 (8bit parallel output)
- Picture size
VGA, QVGA, QQVGA, CIF, QCIF, subQCIF (Sub-sampling , Windowing)
- Readout internal parameters
Sensor gain setting, Electrical shutter exposure period, ALC and AWB reference value
- Auto electrical shutter control (AES), auto gain control (AGC) and auto white balance (AWB) circuit
- Flickerless auto luminance control (ALC=AES+AGC) and auto flicker detection circuit for AC 50Hz / 60Hz fluorescent light
- Automatically blemish correction
- Vertical and Horizontal flip mode

TOSHIBA is continually working to improve the quality and the reliability of its products. Nevertheless, semiconductor devices in general can malfunction or fail due to their inherent electrical sensitivity and vulnerability to physical stress. It is the responsibility of the buyer, when utilizing TOSHIBA products, to observe standards of safety, and to avoid situations in which a malfunction or failure of a TOSHIBA product could cause loss of human life, bodily injury or damage to property. In developing your designs, please ensure that TOSHIBA products are used within specified operating range as set forth in the most recent products specifications. Also, please keep in mind the precautions and conditions set forth in the TOSHIBA Semiconductor Reliability Handbook.

The products described in this document are subject to foreign exchange and foreign trade control laws.

The information contained herein is presented only as a guide for the applications of our products. No responsibility is assumed by TOSHIBA CORPORATION for any infringements of intellectual property or other rights of the third parties which may result from its use. No license is granted by implication or otherwise under any intellectual property or other rights of TOSHIBA CORPORATION or others.

The information contained herein is subject to change without notice.

UPDATE INFORMATION

Ver. 1.20 Jan-05, 2004
Ver. 1.10 Dec-23, 2003
Ver. 1.09 Dec-16, 2003
Ver. 1.08 Oct-29, 2003
Ver. 1.07 Oct-07, 2003
Ver. 1.06 Sep-19, 2003
Ver. 1.05 Sep-08, 2003
Ver. 1.04 Aug-11, 2003
Ver. 1.03 Jul-31, 2003
Ver. 1.02 Jul-16, 2003
Ver. 1.01 Jul-03, 2003
Ver. 1.00 Jun-25, 2003

TEMPORATIVE

BLOCK DIAGRAM

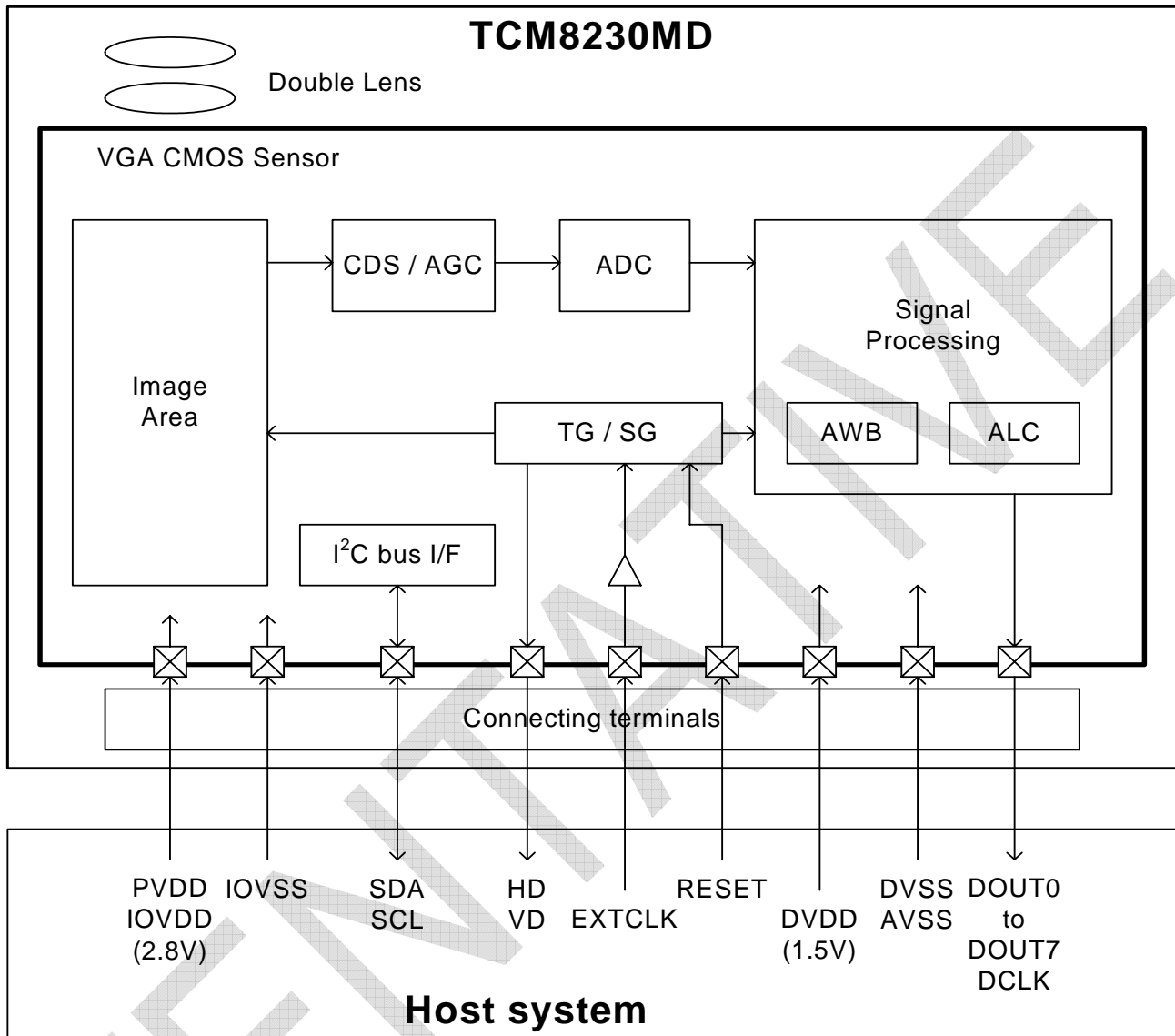

- CDS : Correlated Double Sampling
- AGC : Automatic Gain Control
- ADC : Analog to Digital Converter
- TG : Timing pulse Generator
- SG : Sync pulse Generator
- AWB : Auto White Balance
- ALC : Auto Luminance Control

PIN LAYOUT

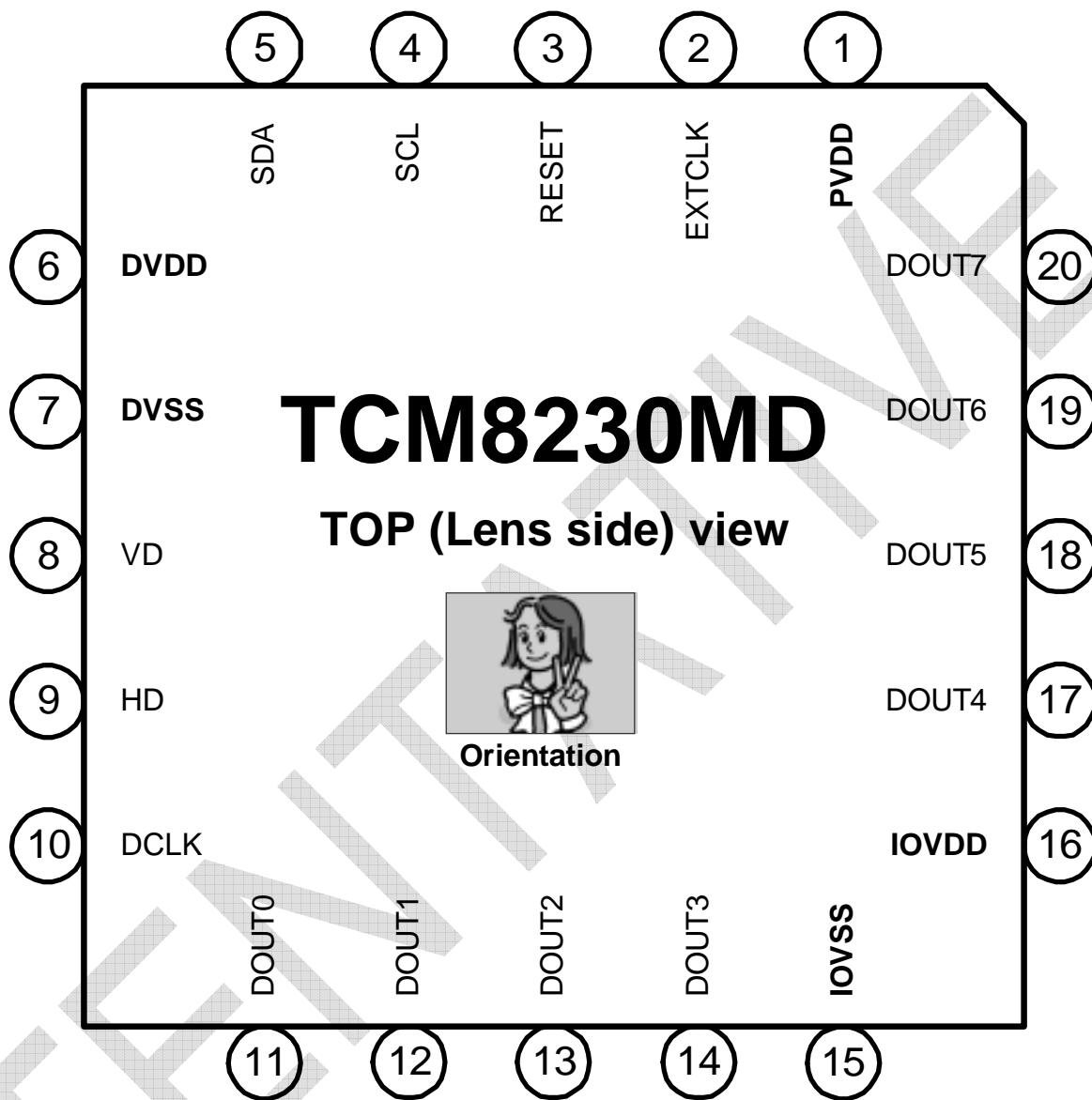

PIN FUNCTIONS

No.	NAME	I/O	FUNCTION
1	PVDD	-	VDD for sensor (photo diode) (2.8V)
2	EXTCLK	I	Clock for external input
3	RESET	I	RESET terminal ("L" active)
4	SCL	I	Clock for I ² C-bus command
5	SDA	I/O	Data for I ² C-bus command
6	DVDD	-	VDD for digital circuits, (1.5V) VDD for sensor (A/D converter) (1.5V)
7	DVSS	-	GND for digital circuits GND for sensor (A/D converter) GND for sensor (photo diode)
8	VD	O	Vertical synchronization pulse output
9	HD	O	Horizontal synchronization pulse output
10	DCLK	O	Clock for output data
11	DOUT0	O	Data output (LSB)
12	DOUT1	O	Data output
13	DOUT2	O	Data output
14	DOUT3	O	Data output
15	IOVSS	-	GND for I/O
16	IOVDD	-	VDD for I/O (2.8V)
17	DOUT4	O	Data output
18	DOUT5	O	Data output
19	DOUT6	O	Data output
20	DOUT7	O	Data output (MSB)

INTERFACE CIRCUITS

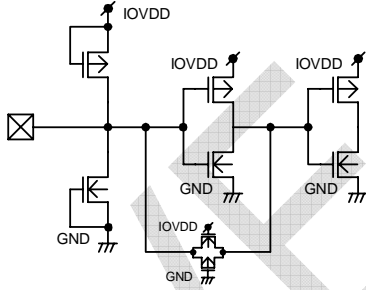
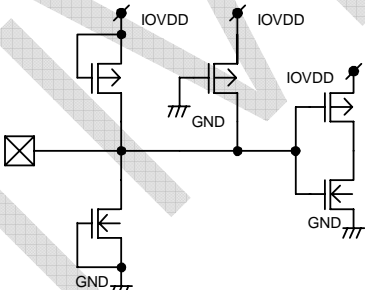
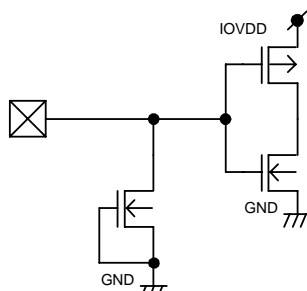
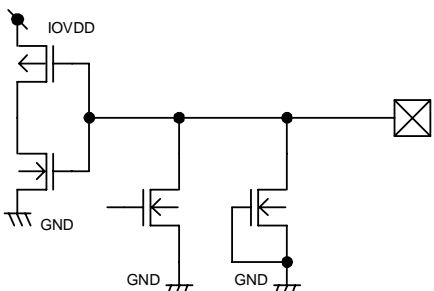
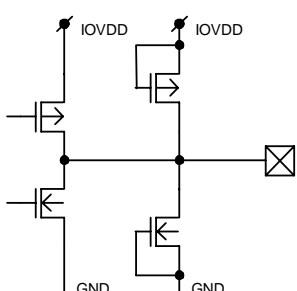
PIN No.	NAME	I/O	INTERFACE CIRCUIT
2	EXTCLK	I	
3	RESET ("L" active)	I	
4	SCL	I	
5	SDA	I/O	
8-14, 17-20	DOUT0 to DOUT7, HD, VD, DCLK	O	

PIXEL ARRANGEMENT

1. V_INV=0

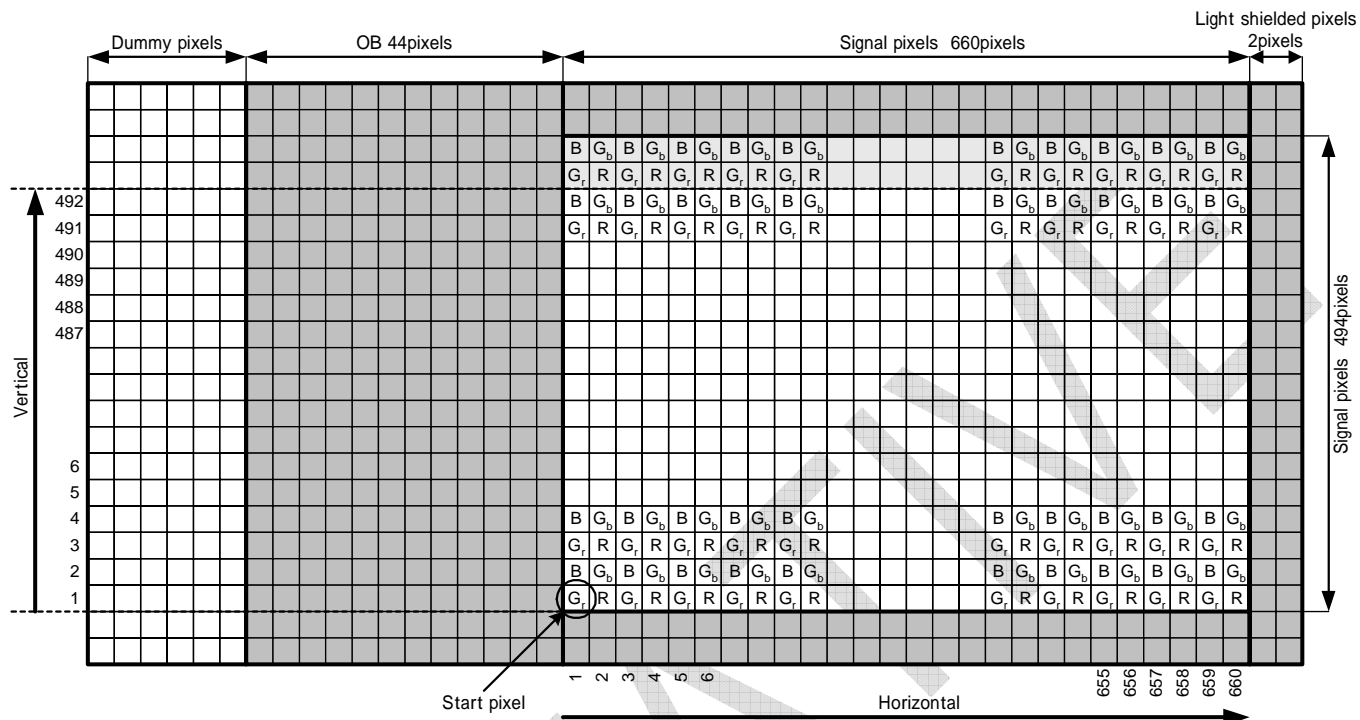

OB: Optical Black R: Red pixels Gr,Gb: Green pixels B: Blue pixels

2. V_INV =1 (Vertical flip mode)

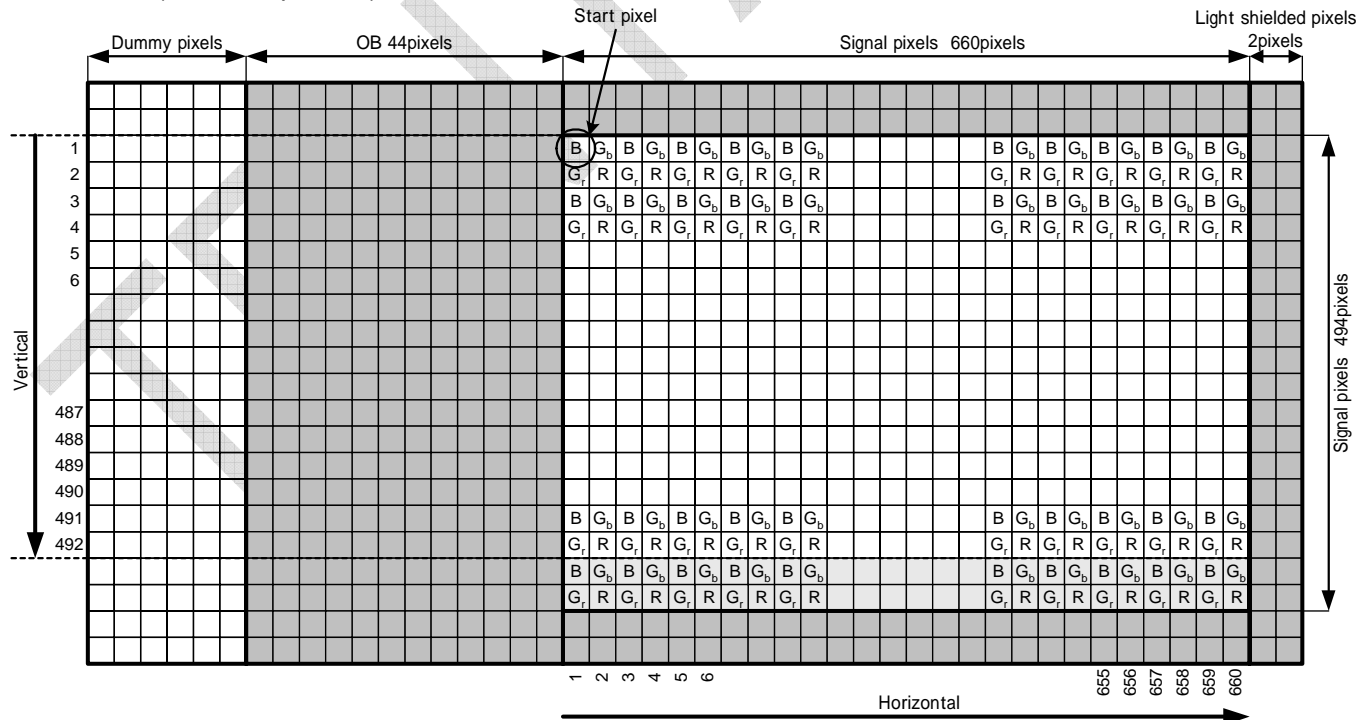

OB: Optical Black R: Red pixels Gr,Gb: Green pixels B: Blue pixels

CONTROL I/F

TCM8230MD(A) control interface configuration is based on fast mode I²C bus.
 Register setting can be changed via I²C bus.
 All register settings are able to read via I²C bus.

Write mode

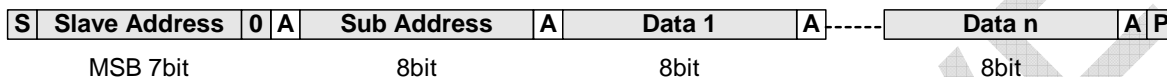

Read mode

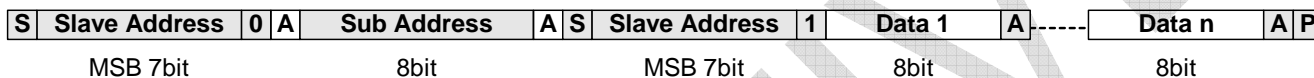

- : Host Command
- : TCM8230MD(A)
- S** : Start condition
- P** : End condition
- A** : Acknowledge

Start condition, End condition

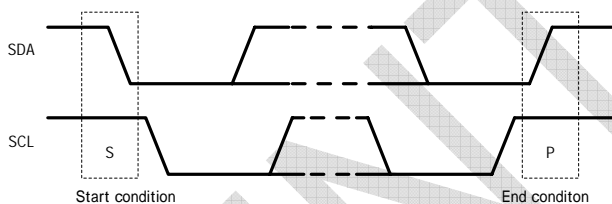

Bit Transfer

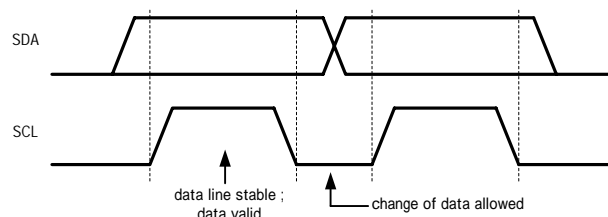

Acknowledge

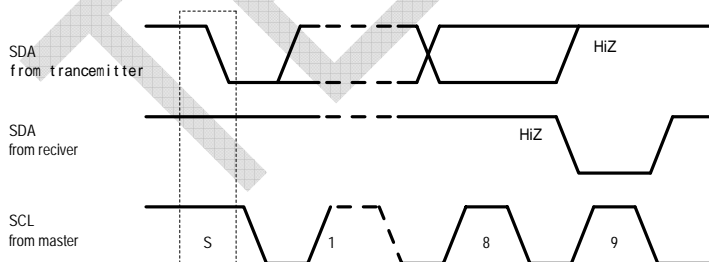

Slave address

A6	A5	A4	A3	A2	A1	A0	R/W
0	1	1	1	1	0	0	1/0

* TCM8230MD(A) use 7bit Slave address

Purchase of TOSHIBA I²C components conveys a license under the Philips I²C Patent Rights to use these components in an I²C system, provided that the system conforms to the I²C Standard Specification as defined by Philips.

INTERNAL REGISTER

ADDRESS			fast								last		default(ROM data)																
DEC	BIN	HEX	BIT7(MSB)	BIT6	BIT5	BIT4	BIT3	BIT2	BIT1	BIT0(LSB)	B7	B6	B5	B4	B3	B2	B1	B0	HEX										
0	00000000	00																		0	1	1	1	0	0	0	0	70	
1	00000001	01	Test Mode																	0	0	0	1	0	0	0	0	10	
2	00000010	02	FPS 0:30fps 1:15fps	ACF 0:50Hz 1:60Hz						DCLKP 0: normal 1: reverse	ACFDET 0: AUTO 1: MANUAL	1	1	0	0	0	0	0	0	40									
3	00000011	03	DOUTSW 0:ON 1:OFF	DATAHZ 0:OUT 1:Hi-Z	PICSIZ [3:0] 0h:VGA 1h:QVGA(f) 2h:QVGA(z) 3h:QQVGA(f) 4h:QQVGA(z) 5h:CIF(f) 6h:QCIF(f) 7h:QCIF(z) 8h:subQCIF(f) 9h:subQCIF(z)					PICFMT 0:YUV422 1:RGB565	CM 0:COLOR 1:B/W	1	0	0	0	0	0	0	80										
4	00000100	04	V_INV 0:normal 1:invert	H_INV 0:normal 1:invert	ESRLSW [1:0] 0h: Short 1h: Long 2h & 3h:		V_LENGTH [3:0]					0	0	0	0	1	1	1	1	0F									
5	00000101	05	ALCSW 0:AUTO 1:MANUAL	ESRLIM [1:0]		ESRSPD [12:8]					0	0	0	0	0	0	1	0	02										
6	00000110	06	ESRSPD [7:0]																	0	0	0	0	1	1	0	1	0D	
7	00000111	07	AG [7:0]																	1	1	0	0	0	0	0	0	C0	
8	00001000	08				ALCMODE [1:0] 0h:Center Weight 1h:Average 2h:Center only 3h:Backlight		ALCH [3:0]					0	0	1	1	1	0	0	38									
9	00001001	09	ALCL [7:0]																	0	1	0	0	0	0	0	0	40	
10	00001010	0A	AWBSW 0:AUTO 1:MANUAL																	0	0	0	0	0	0	0	0	00	
11	00001011	0B	MRG [7:0]																	0	1	0	0	0	0	0	0	40	
12	00001100	0C	MBG [7:0]																	0	1	0	0	0	0	0	0	40	
13	00001101	0D	GAMSW 0:ON 1:OFF																	0	0	0	0	0	0	0	0	00	
14	00001110	0E	HDTG [7:0]																	0	0	1	0	1	1	1	1	2F	
15	00001111	0F	VDTG [7:0]																	0	0	0	0	0	1	0	0	04	
16	00010000	10	HDTCORE [3:0]					VDTCORE [3:0]					0	0	1	0	0	0	1	0	22								
17	00010001	11	CONT [7:0]																	1	0	0	1	1	0	1	0	9A	
18	00010010	12	BRIGHT [7:0]																	0	0	0	0	1	1	0	0	0C	
19	00010011	13																	VHUE [6:0]		0	0	0	0	1	0	1	0A	
20	00010100	14																	UHUE [6:0]		0	0	0	0	1	0	0	08	
21	00010101	15																	VGAIN [5:0]		0	0	1	1	1	0	0	38	
22	00010110	16																	UGAIN [5:0]		0	0	1	1	1	0	0	38	
23	00010111	17																	UVCORE [3:0]		0	0	0	0	0	0	1	01	
24	00011000	18																	SATU [6:0]		0	0	1	0	0	1	1	1	27
25	00011001	19	MHMODE 0: 1:	MHLPFSE L 0: 1:	YMODE [1:0]							MIXHG [2:0]		0	0	0	0	0	1	0	04								
26	00011010	1A																	LENS [5:0]		0	0	1	0	0	0	0	20	
27	00011011	1B	AGLIM [2:0]			LENSRPO L 0:Gain up 1:Gain down		LENSRGAIN [3:0]					0	1	0	0	0	1	1	0	46								
28	00011100	1C	ES100S [7:0]																	1	0	0	1	1	1	1	0	9E	
29	00011101	1D	ES120S [7:0]																	1	0	0	0	0	0	1	1	83	
30	00011110	1E	D_MASK [1:0]		CODESW 0:OFF 1:OUT	CODESEL 0: original 1: ITU656	HSYNCSEL 0: normal 1:	TESPIC 0:Not out 1:Out	PICSEL [1:0] 0h:Colorbar 1h:Ramp1 2h:Ramp2		0	1	1	0	1	0	0	0	68										
31	00011111	1F	SLEEP 0:ACTIVE 1:SLEEP	SRST 0:OFF 1:reset													0	0	0	0	0	0	0	00					

The registers of gray mesh (unassigned registers) are not defined. Input data of the registers of gray mesh must input "0". The registers of testmode must input default data.

ADDRESS			fast							last			default				HEX				
DEC	BIN	HEX	BIT7(MSB)	BIT6	BIT5	BIT4	BIT3	BIT2	BIT1	BIT0(LSB)	B7	B6	B5	B4	B3	B2		B1	B0		
32	00100000	20	HNUM[7:0]										0	0	0	0	0	0	0	0	00
33	00100001	21	HPPH[7:0]										0	0	0	0	0	0	0	1	01
34	00100010	22	HPPH[8]	VRRPH[6:0]									0	0	1	0	0	1	1	0	26
35	00100011	23	HDSPPH[7:0]										0	1	0	0	0	0	0	0	40
36	00100100	24	HDSPPH[8]	VDSPPH[6:0]									0	0	1	0	0	1	1	1	27
37	00100101	25	HAPRPH[7:0]										0	1	0	1	1	1	1	1	5F
38	00100110	26	HAPRPH[8]										0	0	0	0	0	0	0	0	00
39	00100111	27	HOUTPH[7:0]										0	0	0	1	0	1	1	0	16
40	00101000	28	HOUTPH[8]	VOUTPH[6:0]									0	0	1	0	0	0	1	1	23
41	00101001	29	FSSTB5W 0: NOT OUT 1: OUT	FSSTBPOL 0: normal 1: invert				FSSTBPH[3:0]						0	0	0	0	1	0	0	08
42	00101010	2A								FSSTBW[3:0]						0	0	0	0	08	
43	00101011	2B								SCMD[19:16]						0	0	0	0	04	
44	00101100	2C	SCMD[15:8]										0	0	0	0	0	0	0	0	00
45	00101101	2D	SCMD[7:0]										0	0	0	0	0	0	0	0	00
46	00101110	2E	TCSB1L 0: 1:	TCPEROSW [2:0]			TCSBIN 0: 1:	TCRAM 0: 1:	TROM[1:0]						0	0	0	0	0	0	00
47	00101111	2F	TCRAMS 0: 1:	TSPCHK 0: 1:	TCPERAGC	TALCRST	TWBS	TWBG	TACDET[1:0]						0	0	0	0	0	0	00
48	00110000	30	TGAMROM 0: 1:					TCSB[3:0]						0	0	0	0	0	0	00	
49	00110001	31	TALCDISP 0: 1:	TALCOSW[2:0]			PBDISP[1:0]		TDISP[1:0]						0	0	0	0	0	00	
50	00110010	32	ESROUT[14:8]										0	0	0	0	0	0	0	00	
51	00110011	33	ESROUT[7:0]										0	0	0	0	0	0	0	00	
52	00110100	34	AGOUT[7:0]										0	0	0	0	0	0	0	00	
53	00110101	35					DGOUT[5:0]						0	0	0	0	0	0	0	00	
54	00110110	36	ALCDATA[7:0]										0	0	0	0	0	0	0	00	
55	00110111	37	AWBRYDA[7:0]										0	0	0	0	0	0	0	00	
56	00111000	38	AWBBYDA[7:0]										0	0	0	0	0	0	0	00	
57	00111001	39	AGSLOW1[1:0]	FLLSMODE[1:0]		FLLSLIM[3:0]						1	0	0	0	1	1	0	0	8C	
58	00111010	3A	DETSEL[3:0]			ACDETNC[3:0]						1	1	0	0	1	1	1	1	CF	
59	00111011	3B	AGSLOW2[1:0]	DG[5:0]									1	0	0	0	0	0	00		
60	00111100	3C	REJHLEV[7:0]										0	0	0	0	0	0	0	00	
61	00111101	3D	ALCLOCK 0: 1:	ALCSENKSW 0: 1:	ALCSPD[1:0]		ALCSTEP[1:0]		REJH[1:0]						0	0	0	1	0	1	17
62	00111110	3E	SHESRSW 0:Disable 1:Enable	ESLIMSEL 0: 1:	SHESRSPD[1:0]		ELSTEP[1:0]		ELSTART[1:0]						1	0	0	0	0	1	85
63	00111111	3F	AGMIN[7:0]										1	1	0	0	0	0	0	0	C0

The registers of gray mesh (unassigned registers) are not defined. Input data of the registers of gray mesh must input "0". The registers of testmode must input default data.

ADDRESS			fast								last				default				HEX		
DEC	BIN	HEX	BIT7(MSB)	BIT6	BIT5	BIT4	BIT3	BIT2	BIT1	BIT0(LSB)	B7	B6	B5	B4	B3	B2	B1	B0	HEX		
64	01000000	40	LI1POL 0: 1:	CS1POL 0: 1:	LI3POL 0: 1:	CS3POL 0: 1:				DINCKSW 0: 1:	0	0	0	0	0	0	0	0	00		
65	01000001	41	JAMP 0: 1:	JAMG[6:0]								0	0	0	0	0	0	0	0	0	00
66	01000010	42			PREGRG[5:0]						0	0	0	0	0	0	0	0	0	00	
67	01000011	43			PREGBG[5:0]						0	0	0	0	0	0	0	0	0	00	
68	01000100	44			PREREG[5:0]						0	0	0	1	0	1	0	1		15	
69	01000101	45			PREBG[5:0]						0	0	0	1	1	1	1	1		1F	
70	01000110	46									0	0	0	0	0	0	0	0		00	
71	01000111	47		MSKBR[6:0]						0	1	0	0	0	0	1	0	0		44	
72	01001000	48		MSKGR[6:0]						0	1	0	0	0	0	1	0	0		44	
73	01001001	49		MSKRB[6:0]						0	0	1	0	0	0	0	0	0		20	
74	01001010	4A		MSKGB[6:0]						0	1	0	0	0	0	1	0	1		45	
75	01001011	4B		MSKRG[6:0]						0	1	1	0	0	0	1	1	0		66	
76	01001100	4C		MSKBG[6:0]						0	0	1	1	0	0	0	0	0		30	
77	01001101	4D	HDTCSW 0: 1:	VDTCSW 0: 1:	DTCYLV[5:0]						1	1	1	0	0	0	0	0		E0	
78	01001110	4E	HDTPSW 0: 1:	VDTPSW 0: 1:	DTCGAIN[5:0]						0	0	1	0	0	0	0	0		20	
79	01001111	4F	LI12POL 0: 1:	CS12POL 0: 1:		DTLLIMSW 0: 1:	DTLYLIM [3:0]				0	0	0	0	1	0	0	1		09	
80	01010000	50	YLCUTLMSK 0: 1:		YLCUTL[5:0]						0	0	0	0	0	0	1	1	1		07
81	01010001	51	YLCUTHMSK 0: 1:		YLCUTH[5:0]						0	0	1	0	1	1	1	1		2F	
82	01010010	52		UVSKNC[6:0]						0	0	0	0	0	0	0	1	0		02	
83	01010011	53		UVLJ[6:0]						0	0	0	0	0	0	0	0	0		00	
84	01010100	54	WBGMIN[7:0]								0	0	1	0	1	0	1	1		2B	
85	01010101	55	WBGMAX[7:0]								0	1	1	0	0	0	0	0		60	
86	01010110	56	WBDCSPOLE 0: 1:	WBDIVCLP 0: 1:	WBNOLJ[1:0]		WBNOLJSC 0: 1:	WB2IM1 0: 1:	WBSPDUP[1:0]			0	1	0	0	0	0	0		40	
87	01010111	57								WBDIVSC[2:0]		0	0	0	0	0	1	1	0	06	
88	01011000	58		ALLAREA 0: 1:	WBLOCK 0: 1:	WB2SP [3:0]					0	0	1	0	0	0	1	0		22	
89	01011001	59		KIZUSW 0:OFF 1:ON	PBRDSW				ABCSW[1:0]		0	0	1	0	0	0	1	1		23	
90	01011010	5A	PBDLV[7:0]								0	0	0	0	1	0	0	0		08	
91	01011011	5B	PBC1LV[7:0]								0	0	0	0	0	1	0	0		04	
92	01011100	5C	PBC2LV[7:0]								0	0	0	0	1	0	0	0		08	
93	01011101	5D	PBC3LV[7:0]								0	0	0	0	1	0	0	0		08	
94	01011110	5E	PBC4LV[7:0]								0	0	0	0	1	0	0	0		08	

The registers of gray mesh (unassigned registers) are not defined. Input data of the registers of gray mesh must input "0". The registers of testmode must input default data.

OUTLINE OF INTERNAL REGISTER

- * Frame rate setting (30fps, 15fps)
- * Picture size setting of digital output (VGA, QVGA, QQVGA, CIF, QCIF, subQCIF)
- * Selection of digital data output format (8bit YUV422, RGB565)
- * Sync. code setting (ON/OFF, 2 mode)
- * Color signal adjustment (Masking, color axis correction, saturation, etc.)
- * Luminance signal adjustment (Contrast, Brightness, Gamma, H,V edge enhancement)
- * ALC ON/OFF
- * ALC mode setting (area selection, speed selection, flicker reduction mode setting)
- * AWB ON/OFF
- * Vertical and Horizontal flip
- * Sleep mode setting
- * Some kinds of correction setting (Lens shading correction etc.)

8bit parallel image data

	YUV mode				RGB mode	
	1st	2nd	3rd	4th	1st	2nd
DOUT0	U0(n)	Y0(n)	V0(n)	Y0(n+1)	B0	G3
DOUT1	U1(n)	Y1(n)	V1(n)	Y1(n+1)	B1	G4
DOUT2	U2(n)	Y2(n)	V2(n)	Y2(n+1)	B2	G5
DOUT3	U3(n)	Y3(n)	V3(n)	Y3(n+1)	B3	R0
DOUT4	U4(n)	Y4(n)	V4(n)	Y4(n+1)	B4	R1
DOUT5	U5(n)	Y5(n)	V5(n)	Y5(n+1)	G0	R2
DOUT6	U6(n)	Y6(n)	V6(n)	Y6(n+1)	G1	R3
DOUT7	U7(n)	Y7(n)	V7(n)	Y7(n+1)	G2	R4

Image size format

Image size	Display mode	Pixels per H	Effective H lines	Start point (H, V)	End point (H, V)	DCLK mode	Operation mode	Resizing method
VGA	Full	640	480	(1, 1)	(640, 480)	1	Normal	-
QVGA	Full	320	240	(1, 1)	(639, 479)	1/2	Low power	Sub-sampling from VGA
	Zoom x 2			(161, 121)	(480, 360)			Normal
QQVGA	Full	160	120	(1, 1)	(637, 477)	1/2	Low power	Sub-sampling from QVGA(f)
	Zoom x 2			(161, 121)	(479, 359)			Normal
CIF	Full	352	288	(21, 1)	(608, 478)	1	Normal	3/5 filtering from VGA
QCIF	Full	176	144	(21, 1)	(608, 478)	1/2	Low power	3/5 filtering from QVGA(f)
	Zoom x 2			(173, 121)	(466, 360)			Normal
subQCIF	Full	128	96	(1, 1)	(636, 476)	1/2	Low Power	4/5 filtering from QQVGA(f)
	Zoom x 2			(161, 121)	(479, 359)			Normal

QVGA(f) means QVGA full.
 QQVGA(f) means QVGA full.

- VGA Video Graphics Array
- QVGA Quarter VGA
- QQVGA Quarter QVGA
- CIF Common Intermediate Format
- QCIF Quarter CIF

SYNCHRONIZATION CODE

Synchronization code output format

CODESW=1

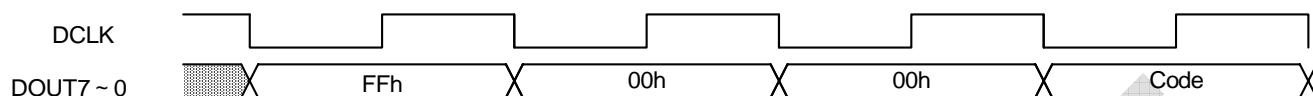

CODESW(Address=1Eh, Bit5) is able to add synchronization codes. "Code" part is changed Mode1 or Mode2 by CODESEL(Address=1Eh, Bit4).

Mode1 (Original format, CODESEL=0)

These codes only exists in active lines

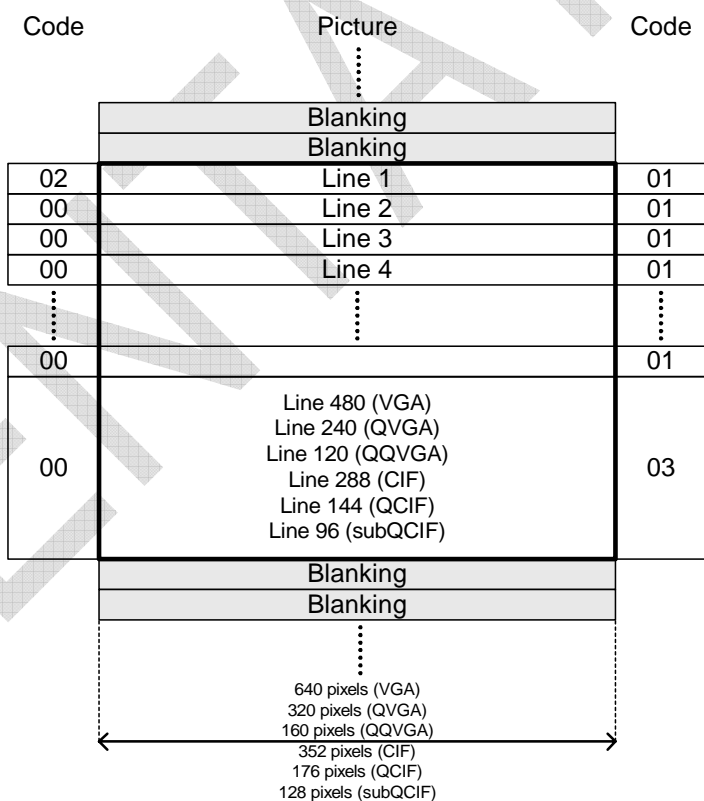
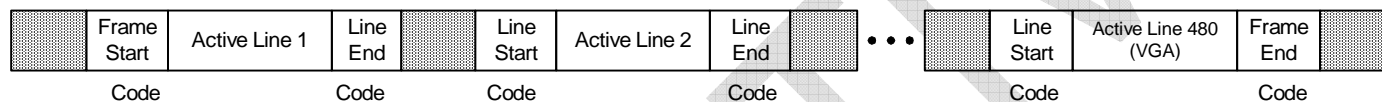

Line start code : FFh 00h 00h 00h
 Line end code : FFh 00h 00h 01h
 Frame start code : FFh 00h 00h 02h
 Frame end code : FFh 00h 00h 03h

Mode2 (ITU656 format, CODESEL=1)

These codes exists in every lines

Code

1	0	V	H	0	0	0	0
---	---	---	---	---	---	---	---

V : 1:Blanking 0:Active Line

H : 1:End of Active Pixel 0:Start of Active Pixel

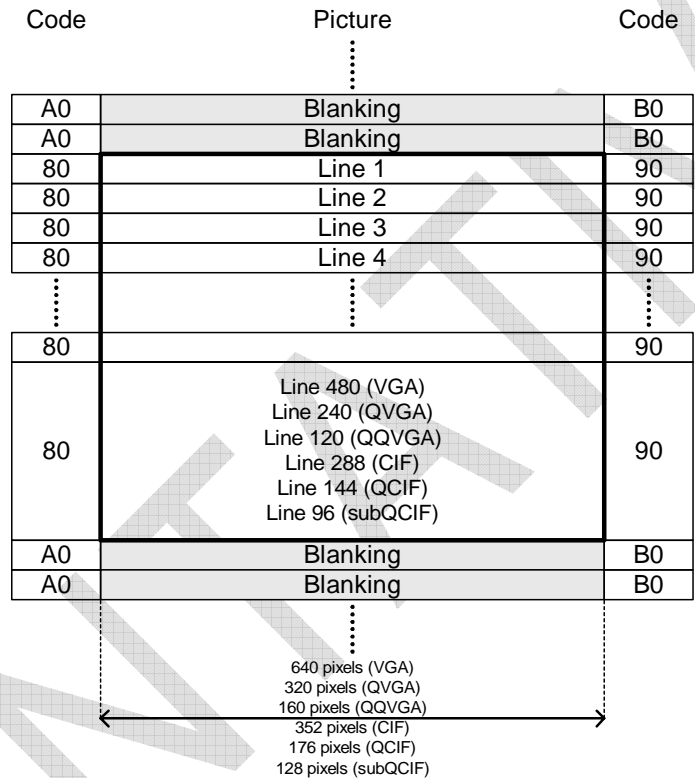

- Blanking and start active pixel code : FFh 00h 00h A0h
- Blanking and endactive pixel code : FFh 00h 00h B0h
- Active line and start active pixel code : FFh 00h 00h 80h
- Active line and end active pixel code : FFh 00h 00h 90h

DATA OUTPUT TIMING CHART

TCM8230MD supports 2 HD pulses, one is "Blanking pulse", and another one is "Normal pulse". You can choose HD pulse by HSYNCSEL (Address=1Eh Bit3).

Pixel Size mode (HD=Blanking pulse)

1. Vertical timing (HSYNCSEL=1)

Normal operation mode
(VGA, CIF(full), QVGA(zoom), QCIF(zoom))

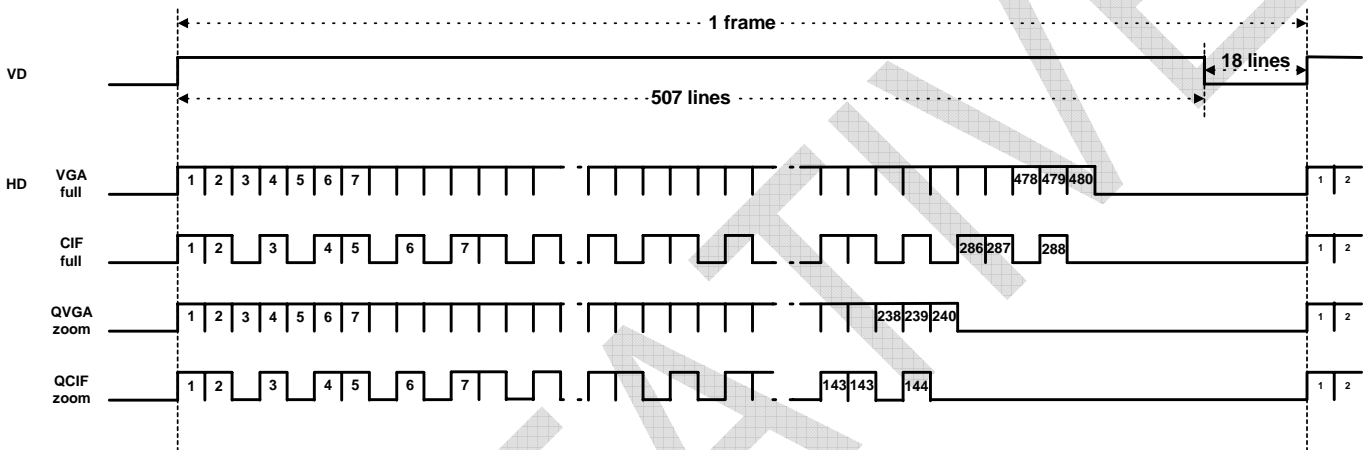

Low power operation mode
(QVGA(full), QQVGA(full), QQVGA(zoom), QCIF(full), subQCIF(full), subQCIF(zoom))

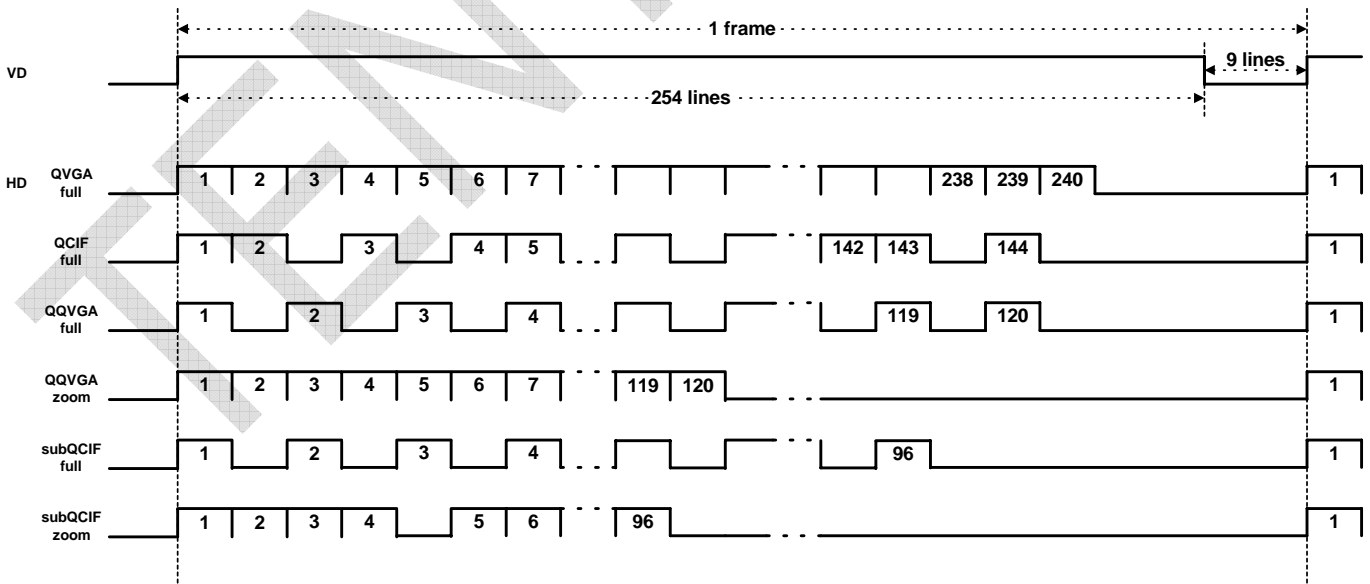

2. Horizontal timing (HSYNCSEL=1)

Normal operation mode

(VGA, CIF (full), QVGA (zoom), QCIF (zoom))

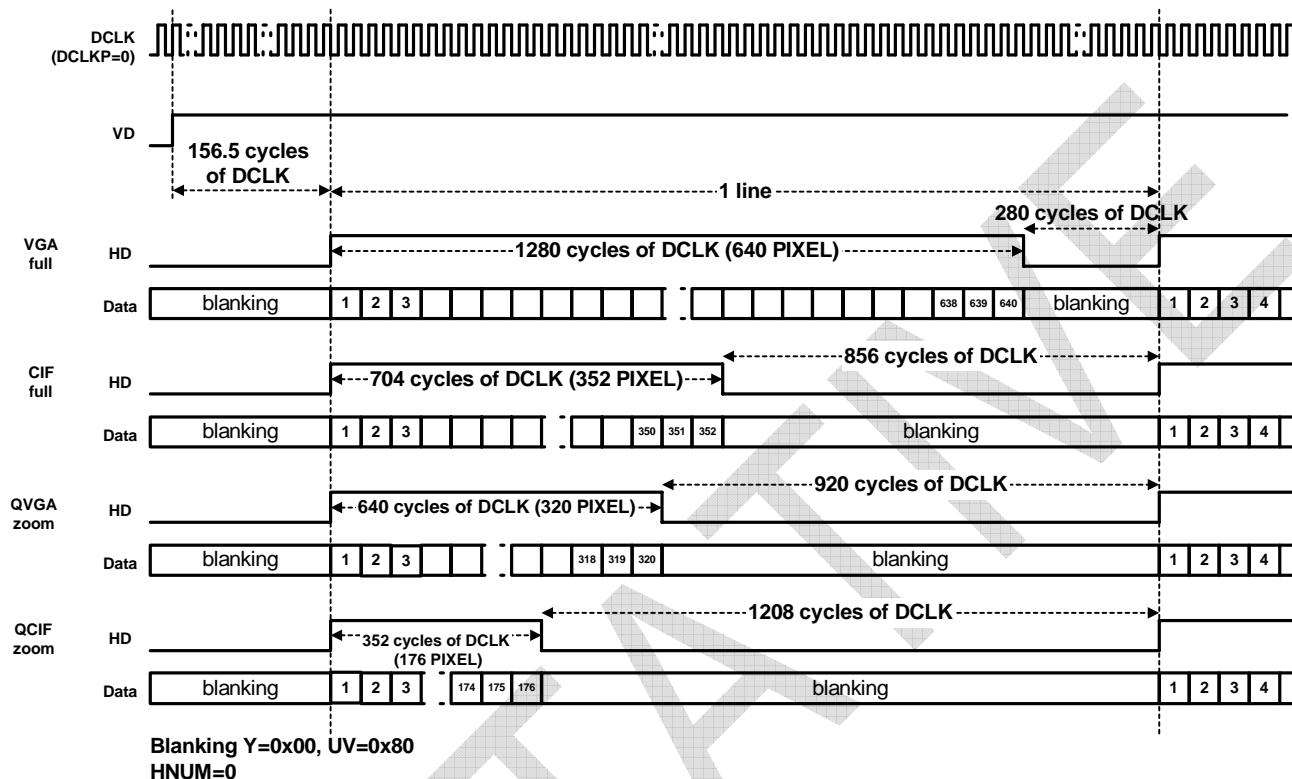

Low power operation mode

(QVGA(full), QQVGA(full), QQVGA(zoom), QCIF(full), subQCIF(full), subQCIF(zoom))

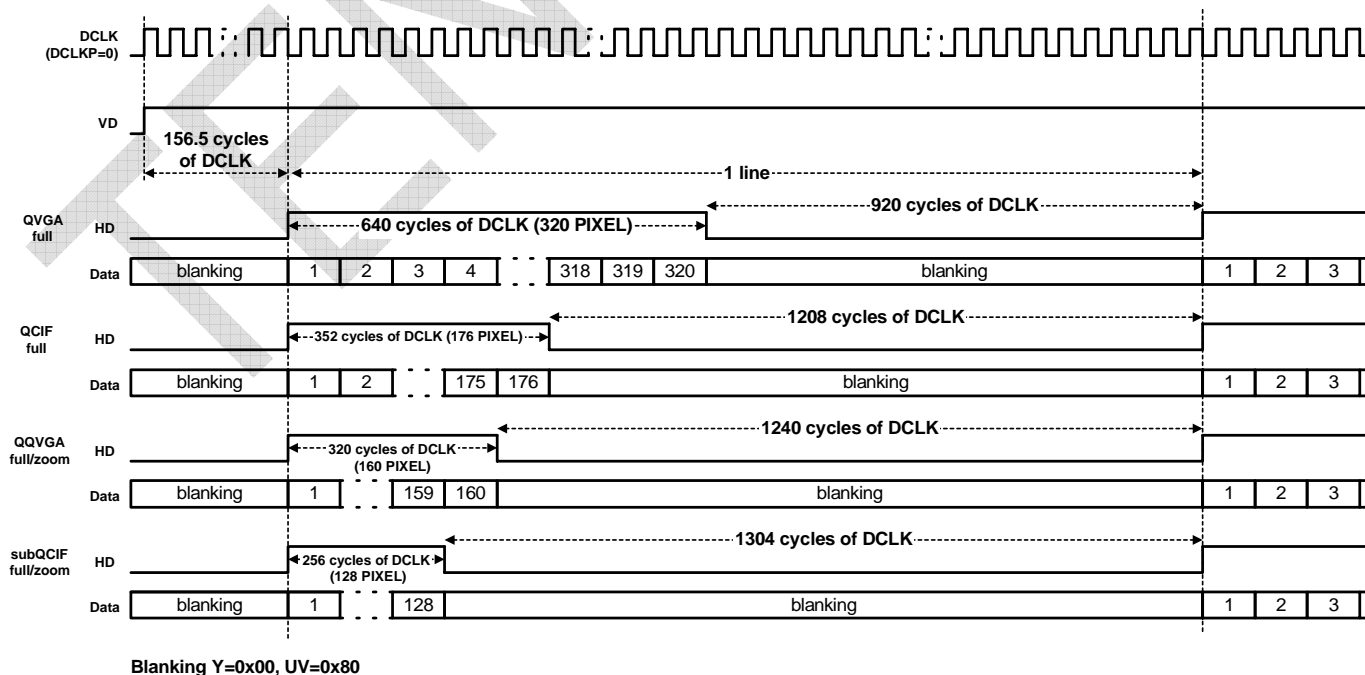

Pixel Size mode (HD=Normal pulse)

1. Vertical timing (HSYNCSEL=0)

**Normal operation mode
(VGA, CIF(full), QVGA(zoom), QCIF(zoom))**

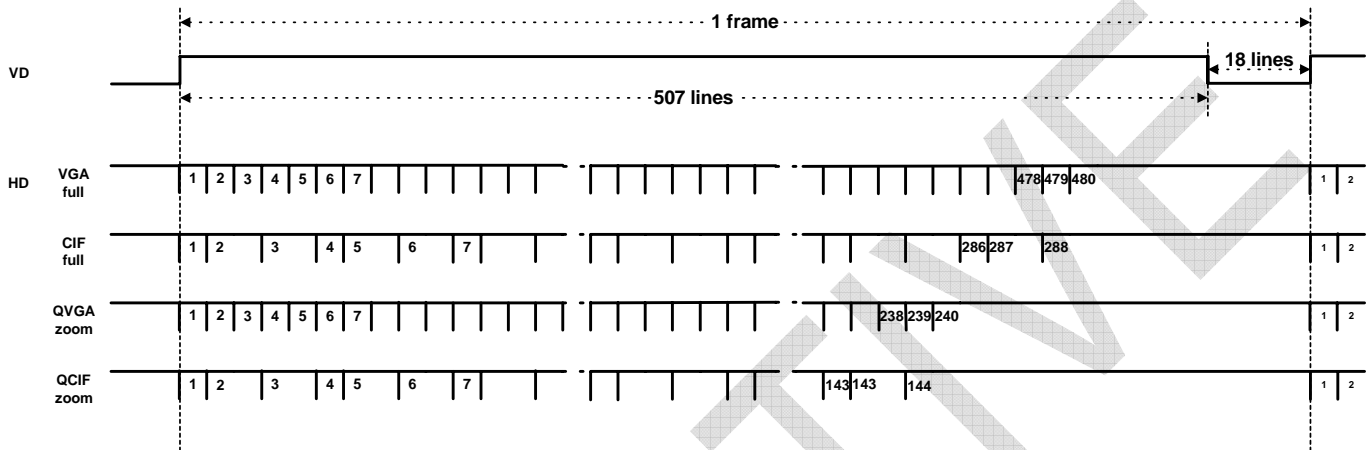

**Low power operation mode
(QVGA(full), QQVGA(full), QQVGA(zoom), QCIF(full), subQCIF(full), subQCIF(zoom))**

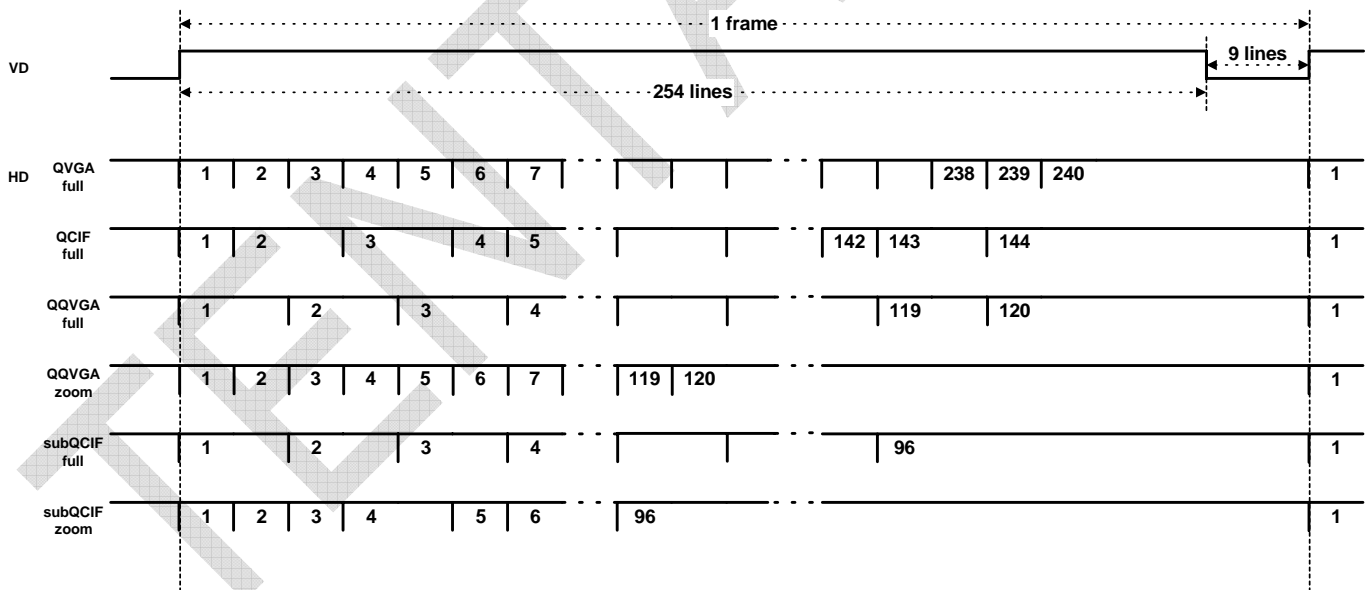

2. Horizontal timing (HSYNCSEL=0)

Normal operation mode

(VGA, CIF (full), QVGA (zoom), QCIF (zoom))

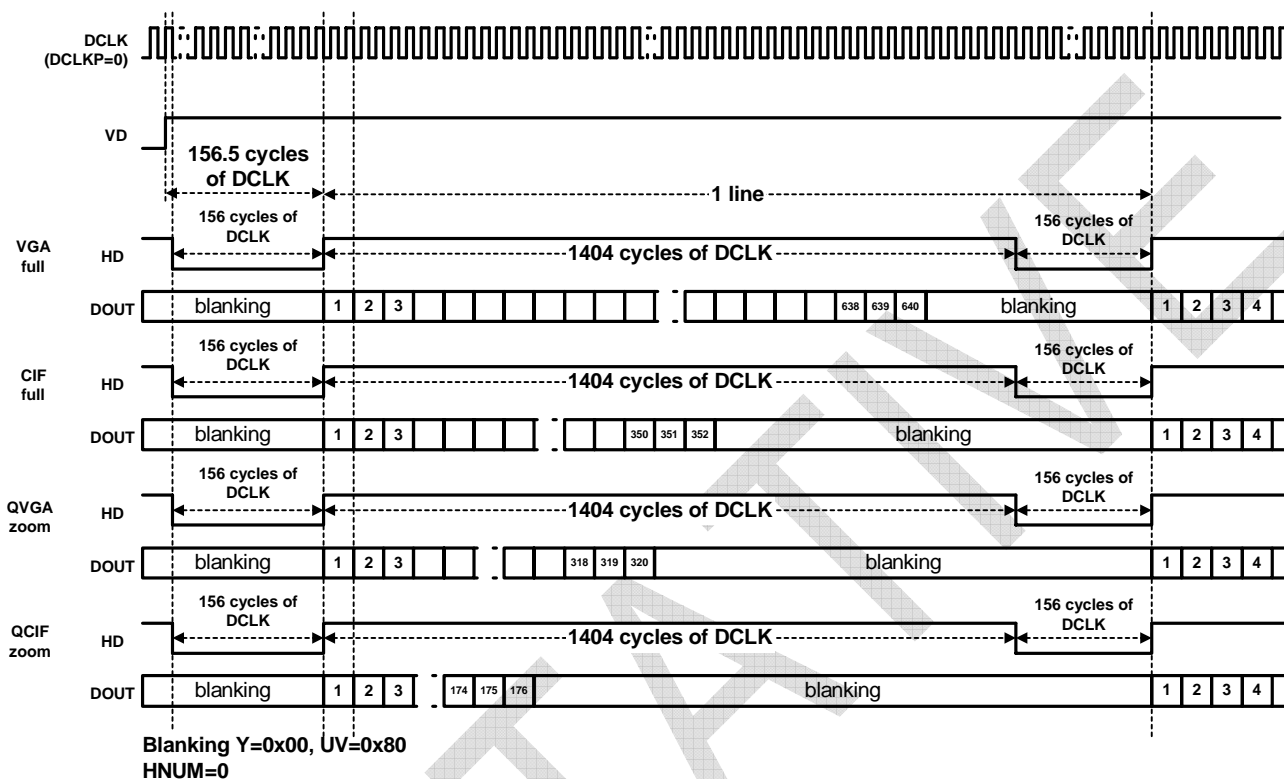

Low power operation mode

(QVGA(full), QQVGA(full), QQVGA(zoom), QCIF(full), subQCIF(full), subQCIF(zoom))

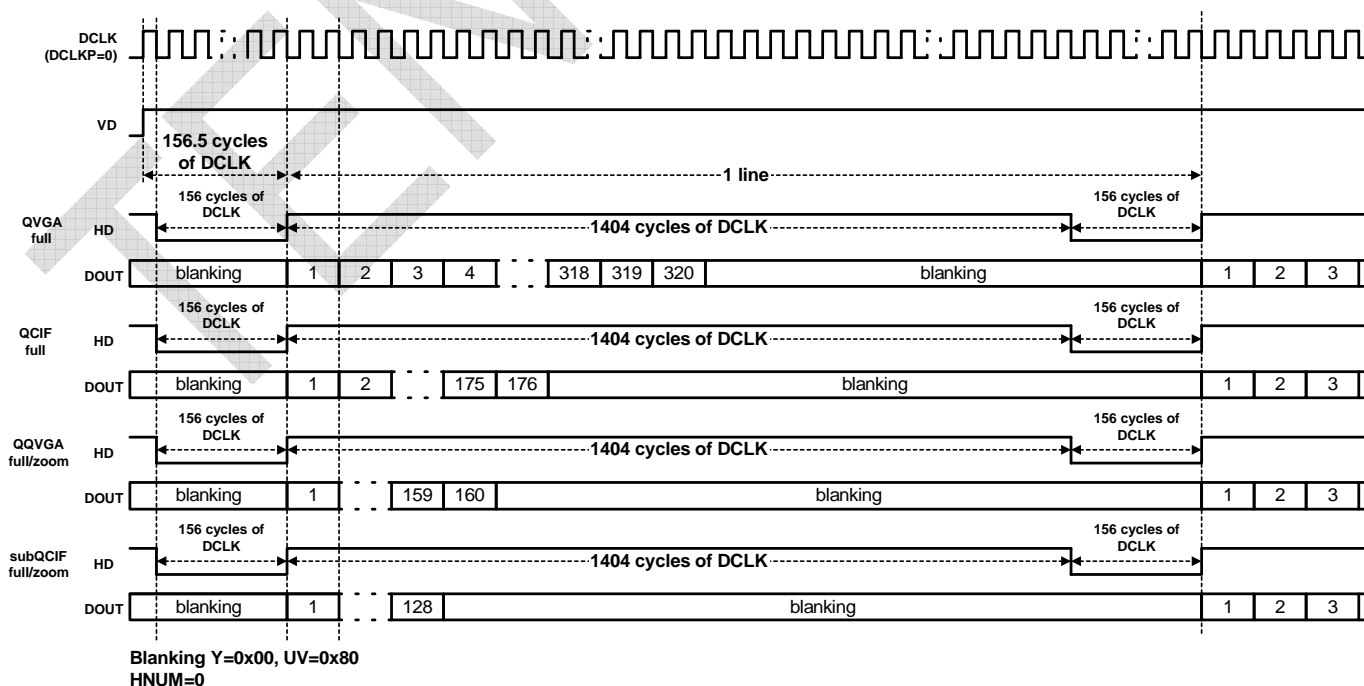

Exposure mode

TCM8230MD supports long exposure time mode (ESRLSW (Address=04h, Bit5,4)= 1) and extra-long exposure time mode (ESRLSW (Address=04h Bit5,4)= 2, 3).

Vertical timing

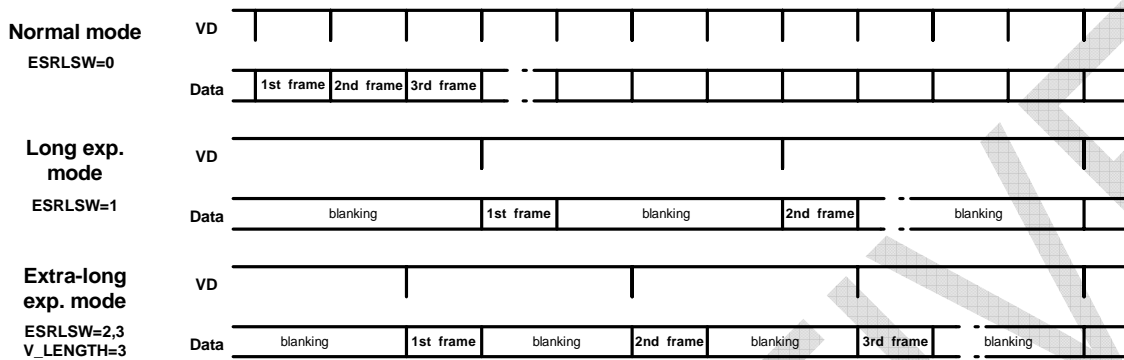

When use these modes, you should be sent below I²C commands before entry these modes.

- ESRLSW (Address=04h Bit5,4)= 1, 2 or 3
- Address=22h, Data=10h (Default Data=26h)
- Address=24h, Data=0Fh (Default Data=27h)
- Address=28h, Data=06h (Default Data=23h)

POWER ON SEQUENCE

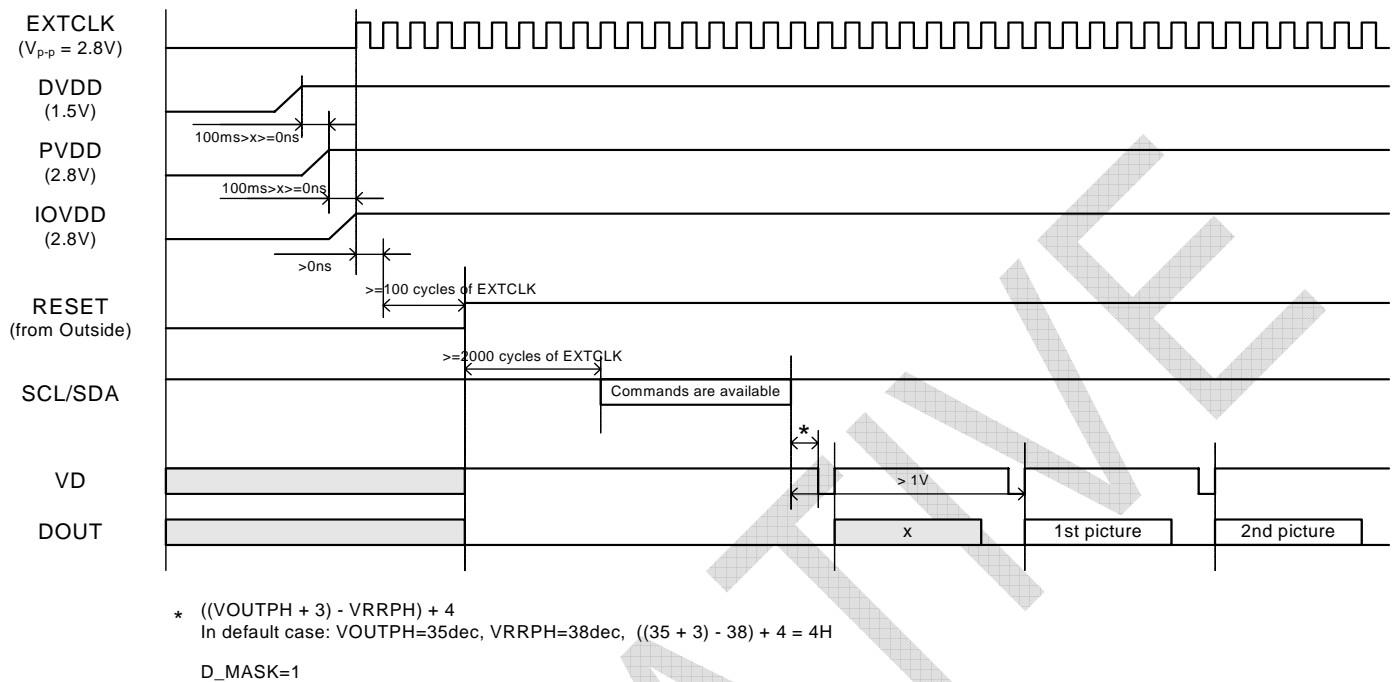

TCM8230MD cannot output pictures after power on immediately. You should be sent some I²C commands after power on as below.

Address=03h, Data=00h (Default Data=80h)

POWER OFF SEQUENCE

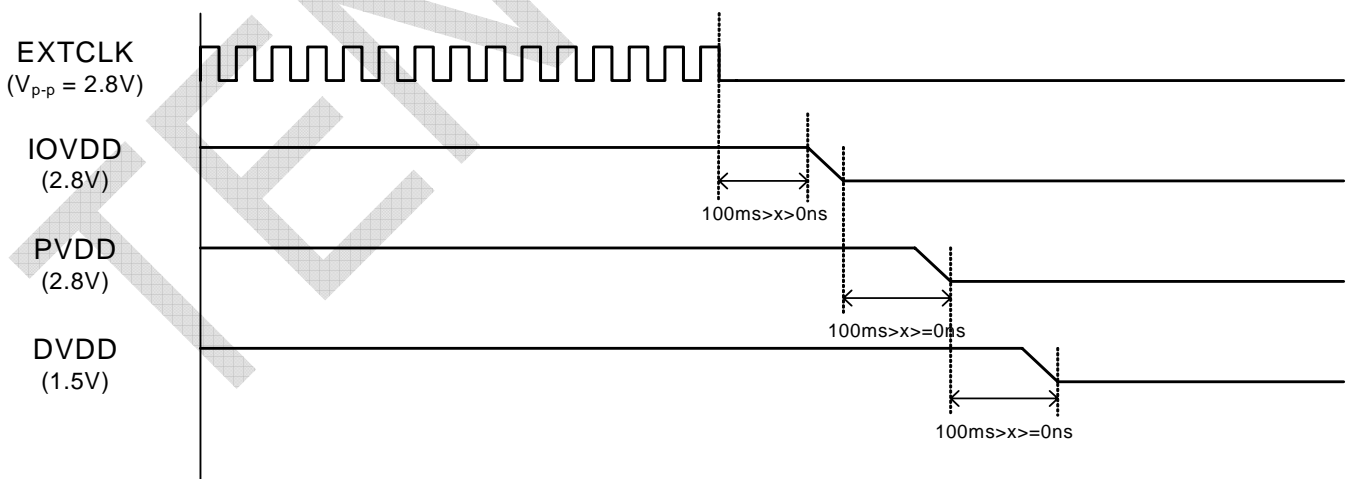

SLEEP MODE SEQUENCE

1. From normal operation to sleep mode

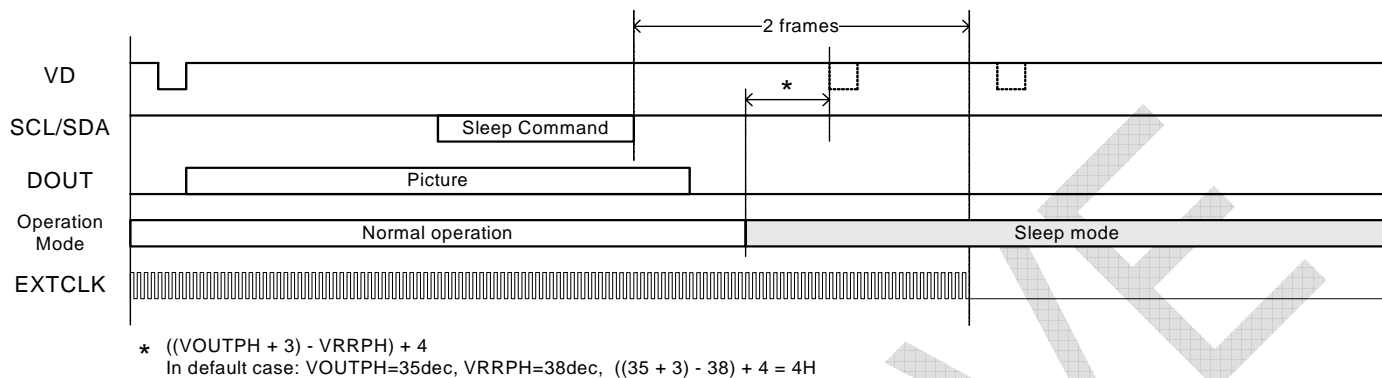

2. From sleep mode to normal operation

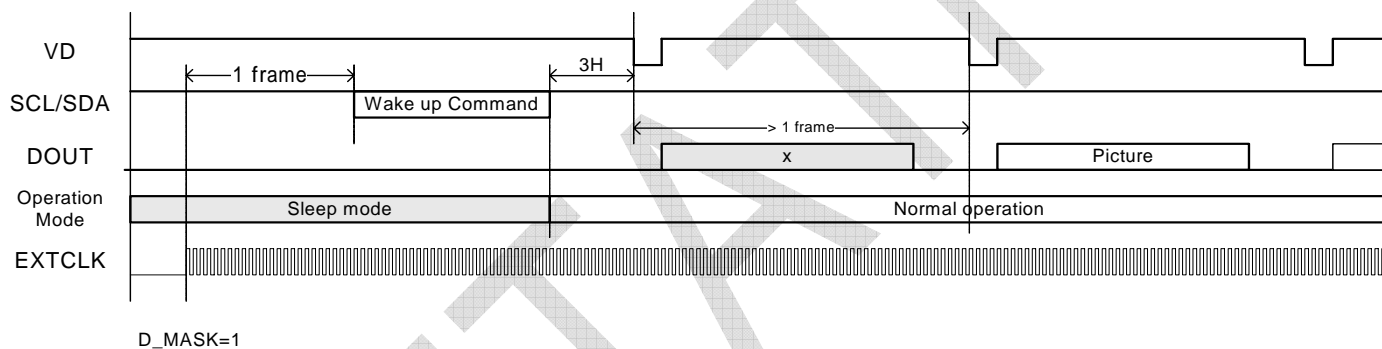

Some registers data, AWB calculated data and ALC calculated data are kept the last values during sleep mode.

MAXIMUM RATING

	RATING		UNITS
	1.5V	2.8V	
Power supply voltage	-0.3 to 3.0	-0.3 to 3.6	V
Storage temperature	-30 to 85		Degree C

RECOMMENDED OPERATING CONDITION

		MIN	TYP	MAX	UNITS
Power supply voltage	IOVDD, PVDD*	2.6	2.8	3.0	V
		2.3	2.5	2.7	
	DVDD	1.4	1.5	1.6	
Operational temperature		-20	-	60	Degree C

*If using 2.5V, must input setting command. (Default setting is 2.8V.)

ELECTRICAL CHARACTERISTICS

DC Characteristic (Ta=25 degree C, DVDD(=AVDD) =1.5V, PVDD= IOVDD =2.8V)

1. POWER

ITEM	CONDITION	MIN	TYP	MAX	UNITS
POWER	VGA(15fps) (Normal operation mode)	-	40	TBD	mA
	Sleep mode	-	-	TBD	uA

* Measurement condition : Machbeth chart (full)

*Peak current = 180mA

2. EXTCLK

ITEM	SYMBOL	CONDITION	MIN	TYP	MAX	UNITS	NOTES
Rectangular shape	LOW level input voltage	$V_{IL;EXTCLK}$	-	-0.3	-	IOVDD*0.2	V
	HIGH level input voltage	$V_{IH;EXTCLK}$	-	IOVDD*0.8	IOVDD	3.0	V
	LOW level input current	$I_{IL;EXTCLK}$	$V_{IN}=GND$	-10	-	10	uA
	HIGH level input current	$I_{IH;EXTCLK}$	$V_{IN}=IOVDD$	-10	-	10	uA
	DUTY	-	-	45/55	50/50	55/45	%

1) Duty referred to 50% level of input EXTCLK

3. SCL and SDA

ITEM	SYMBOL	MIN	TYP	MAX	UNIT	NOTES
SCL	LOW level input voltage	$V_{IL;SCL}$	0.0	-	0.4	V
	HIGH level input voltage	$V_{IH;SCL}$	IOVDD*0.7	IOVDD	3.0	V
SDA	LOW level input voltage	$V_{IL;SDA}$	0.0	-	0.4	V
	HIGH level input voltage	$V_{IH;SDA}$	IOVDD*0.7	IOVDD	3.0	V
	LOW level output voltage (IOL=4mA)	$V_{OL;SDA}$	0.0	-	0.4	V

4. DOUT0 to DOUT7, DCLK, HD and VD

ITEM	SYMBOL	MIN	TYP	MAX	UNIT	NOTES
DOUT0 to DOUT7, DCLK, HD and VD	LOW level output voltage (IOL=2mA)	$V_{OL;DATA}$	0.0	-	0.4	V
	HIGH level output voltage (IOH=-2mA)	$V_{OH;DATA}$	2.4	IOVDD	-	V

5. RESET

ITEM	SYMBOL	CONDITION	MIN	TYP	MAX	UNIT	NOTES
LOW level input voltage	$V_{IL;RESET}$	-	-0.3	-	IOVDD*0.2	V	
HIGH level input voltage	$V_{IH;RESET}$	-	IOVDD*0.8	IOVDD	3.0	V	
LOW level input current	$I_{IL;RESET}$	$V_{IN}=GND$	-10	-	10	uA	
HIGH level input current	$I_{IH;RESET}$	$V_{IN}=IOVDD$	-10	-	10	uA	

AC Characteristic (Ta=25 degree C, DVDD(=AVDD) =1.5V, PVDD= IOVDD =2.8V)

1. EXTCLK

ITEM	SYMBOL	FPS	MIN	TYP	MAX	UNITS	NOTES
Clock frequency	f _{EXTCLK}	0	11.90	24.54	25.00	MHz	*1
		1			27.00		
Rise time	t _{r,EXTCLK}	-	-	-	5	ns	*2
Fall time	t _{f,EXTCLK}	-	-	-	5	ns	

1) FPS : Address=02h, Bit7

2) All values referred to V_{IHmin} and V_{ILmax} levels

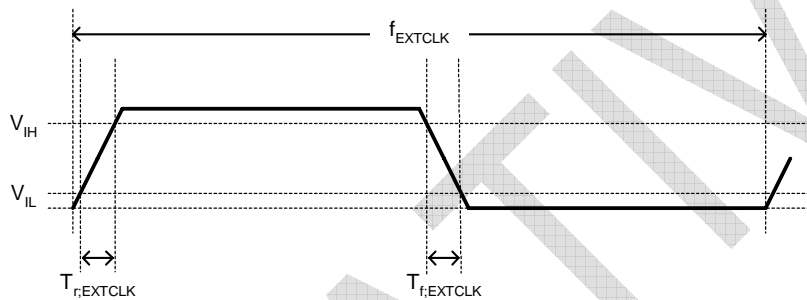

2. EXTCLK input circuit

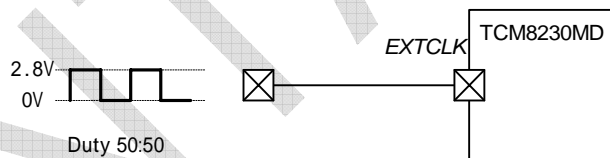

3. SCL and SDA

ITEM		SYMBOL	MIN	MAX	UNITS	NOTES
SCL	Clock frequency	f_{SCL}	-	400	KHz	*1
	Low period	$t_{LOW;SCL}$	1.3	-	us	
	High period	$t_{HIGH;SCL}$	0.6	-	us	
	Rise time	$t_{r;SCL}$	-	300	ns	
	Fall time	$t_{f;SCL}$	-	300	ns	
SDA	Rise time	$t_{r;SDA}$	-	300	ns	
	Fall time	$t_{f;SDA}$	-	300	ns	
Hold time(repeated) START condition After this period, the first clock pulse is		$t_{HD;STA}$	0.6	-	us	
Setup time for a repeated START condition		$t_{SU;STA}$	0.6	-	us	
Data hold time		$t_{HD;DAT}$	0	-	ns	
Data setup time		$t_{SU;DAT}$	100	-	ns	
Setup time for STOP condition		$t_{SU;STO}$	0.6	-	us	
Width of spike pulse	Normal	t_{SP1}	0	50	ns	
	Wake-up from sleep mode	t_{SP2}	0	20	ns	

1) All values referred to V_{IHmin} and V_{ILmax} levels

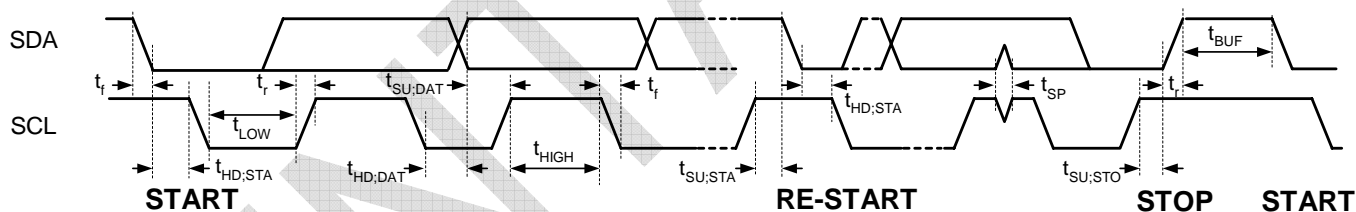

4. DOUT0 to DOUT7, DCLK, HD and VD

ITEM	SYMBOL	MIN	MAX	UNITS	NOTES
DCLK	Rise time	$t_{r,DCLK}$	-	6	ns
	Fall time	$t_{f,DCLK}$	-	6	ns
DOUT0 to DOUT7, HD, and VD	Rise time	$t_{r,DATA}$	-	6	ns
	Fall time	$t_{f,DATA}$	-	6	ns
Setup time of data	$t_{pd,SU}$	10	-	ns	*1
Hold time of data	$t_{pd,HD}$	10	-	ns	

1) All values referred to V_{OHmin} and V_{OLmax} levels

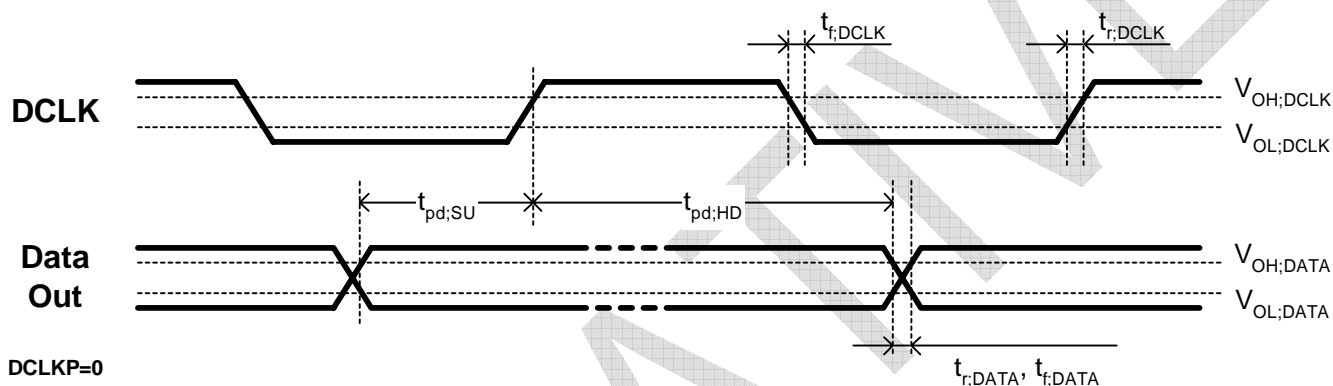

CHARACTERISTICS OF LENS

ITEM	VALUE	UNITS
Optical format	1/6	inch
Field of view	Horizontal	57.4
	Vertical	44.5
	Diagonal	69.1
F number	F2.8	-
TV distortion	-0.4	%
Focal length	TBD	mm
Focusing area	TBD	cm
Manual focusing	Not available	-
Structure	Double lens	-

Appendix 1: Module Drawing

