



50 MHz to 350 MHz CASCADEABLE AMPLIFIER

FEATURES

- High Dynamic Range
 - $OIP_3 = 36 \text{ dBm}$
 - $NF < 4.5 \text{ dB}$
- Single Supply Voltage
- High Speed
 - $V_S = 3 \text{ V to } 5 \text{ V}$
 - $I_S = \text{Adjustable}$
- Input / Output Impedance
 - 50Ω

APPLICATIONS

- IF Amplifier
 - TDMA: GSM, IS-136, EDGE/UWE-136
 - CDMA: IS-95, UMTS, CDMA2000
 - Wireless Local Loop
 - Wireless LAN: IEEE802.11

DESCRIPTION

The THS9001 is a medium power, cascadeable, gain block optimized for high IF frequencies. The amplifier incorporates internal impedance matching to 50Ω , and achieves greater than 15-dB input, and output return loss from 50 MHz to 350 MHz with $V_S = 5 \text{ V}$, $R_{(BIAS)} = 237 \Omega$, $L_{(COL)} = 470 \text{ nH}$. Design requires only 2 dc-blocking capacitors, 1 power-supply bypass capacitor, 1 RF choke, and 1 bias resistor.

Functional Block Diagram

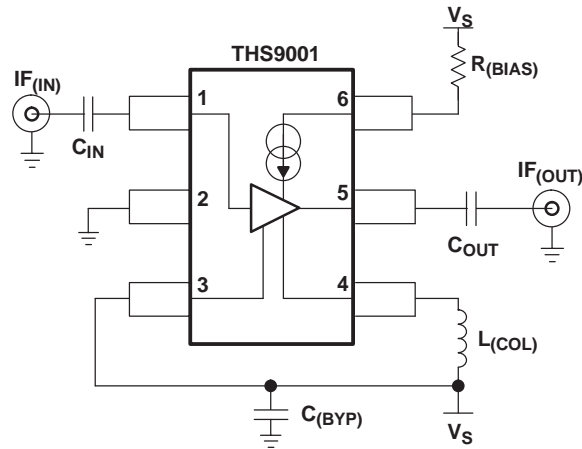

Please be aware that an important notice concerning availability, standard warranty, and use in critical applications of Texas Instruments semiconductor products and disclaimers thereto appears at the end of this data sheet.



These devices have limited built-in ESD protection. The leads should be shorted together or the device placed in conductive foam during storage or handling to prevent electrostatic damage to the MOS gates.

AVAILABLE OPTIONS

PACKAGED DEVICES ⁽¹⁾	PACKAGE TYPE	TRANSPORT MEDIA, QUANTITY
THS9001DBVT	SOT-23-6	Tape and Reel, 250
THS9001DBVR		Tape and Reel, 3000

(1) For the most current package and ordering information, see the Package Option Addendum at the end of this document, or see the TI Web site at www.ti.com.

ABSOLUTE MAXIMUM RATINGS

over operating free-air temperature (unless otherwise noted)⁽¹⁾

			UNIT
V _{SS}	Supply voltage, GND to V _S		5.5 V
V _I	Input voltage		GND to V _S
	Continuous power dissipation		See Dissipation Ratings Table
T _J	Maximum junction temperature		150°C
T _J	Maximum junction temperature, continuous operation, long term reliability ⁽²⁾		125°C
T _{stg}	Storage temperature		-65°C to 150°C
	ESD Ratings	HBM	2000
		CDM	1500
		MM	100

- (1) The absolute maximum ratings under any condition is limited by the constraints of the silicon process. Stresses above these ratings may cause permanent damage. Exposure to absolute maximum conditions for extended periods may degrade device reliability. These are stress ratings only, and functional operation of the device at these or any other conditions beyond those specified is not implied.
- (2) The maximum junction temperature for continuous operation is limited by package constraints. Operation above this temperature may result in reduced reliability and/or lifetime of the device.

DISSIPATION RATING TABLE

PACKAGE	Θ _{JC} (°C/W)	Θ _{JA} (°C/W)	POWER RATING ⁽¹⁾	
			T _A ≤ 25°C	T _A = 85°C
DBV ⁽²⁾	70.1	216	463 mW	185 mW

- (1) Power rating is determined with a junction temperature of 125°C. Thermal management of the final PCB should strive to keep the junction temperature at or below 125°C for best performance.
- (2) This data was taken using the JEDEC standard High-K test PCB.

RECOMMENDED OPERATING CONDITIONS

		MIN	NOM	MAX	UNIT
V _{SS}	Supply voltage	2.7		5	V
T _A	Operating free-air temperature,	-40		85	°C
I _S	Supply current		100		mA

ELECTRICAL CHARACTERISTICS

Typical Performance ($V_S = 5\text{ V}$, $R_{(\text{BIAS})} = 237\ \Omega$, $L_{(\text{COL})} = 470\text{ nH}$) (unless otherwise noted)

PARAMETER	TEST CONDITIONS	MIN	TYP	MAX	UNITS
Gain	f = 50 MHz		15.8		dB
	f = 350 MHz		15.0		
OIP ₃	f = 50 MHz		35		dBm
	f = 350 MHz		37		
1-dB compression	f = 50 MHz		20.6		dBm
	f = 350 MHz		20.6		
Input return loss	f = 50 MHz		15.4		dB
	f = 350 MHz		16.6		
Output return loss	f = 50 MHz		17		dB
	f = 350 MHz		15		
Reverse isolation	f = 50 MHz		20.7		dB
	f = 350 MHz		20.7		
Noise figure	f = 50 MHz		3.7		dB
	f = 350 MHz		4		

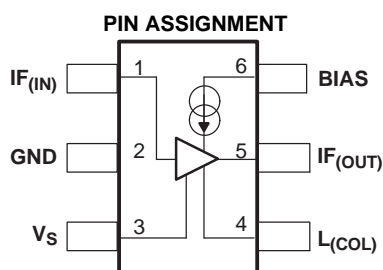

Terminal Functions

Pin Numbers	Name	Description
1	IF _(IN)	Signal input
2	GND	Negative power supply input
3	V _S	Positive power supply input
4	L _(COL)	Output transistor load inductor
5	IF _(OUT)	Signal output
6	BIAS	Bias current input

SIMPLIFIED SCHEMATIC

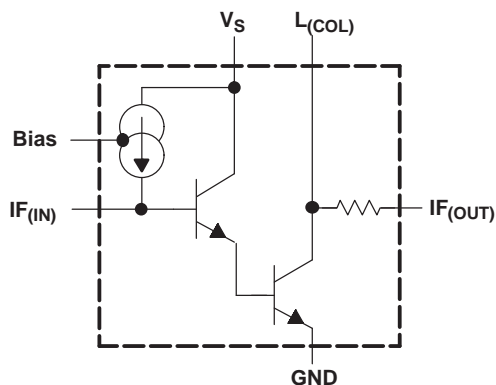

TYPICAL CHARACTERISTICS

TABLE OF GRAPHS

		FIGURE
	S21 Frequency response	1
	S22 Frequency response	2
	S11 Frequency response	3
	S12 Frequency response	4
	S21 vs $R_{(Bias)}$	5
	Noise figure vs Frequency	6
I_S	Supply current vs $R_{(Bias)}$	7
	Output power vs Input power	8
	Adjacent channel (ACPR) and Alternate channel (AltCPR) protection ratios vs Input power	9
	OIP ₂ vs Frequency	10
	OIP ₃ vs Frequency	11
	S21 Frequency response	12
	S22 Frequency response	13
	S11 Frequency response	14
	S12 Frequency response vs Frequency	15
	Noise figure	16
	OIP ₂ vs Frequency	17
	Output power vs Input power	18
	OIP ₃ vs Frequency	19

S-Parameters of THS9001 as mounted on the EVM with $V_S = 5\text{ V}$, $R_{(\text{BIAS})} = 237\ \Omega$, and $L_{(\text{COL})} = 68\text{ nH}$ to 470 nH at room temperature.

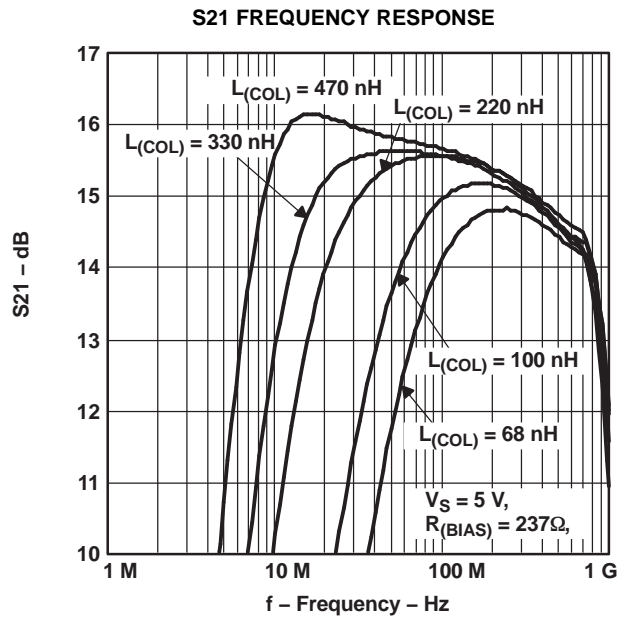

Figure 1.

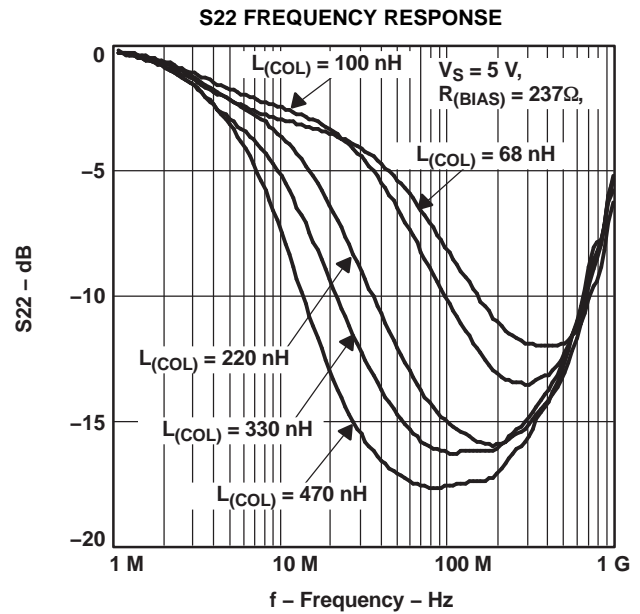

Figure 2.

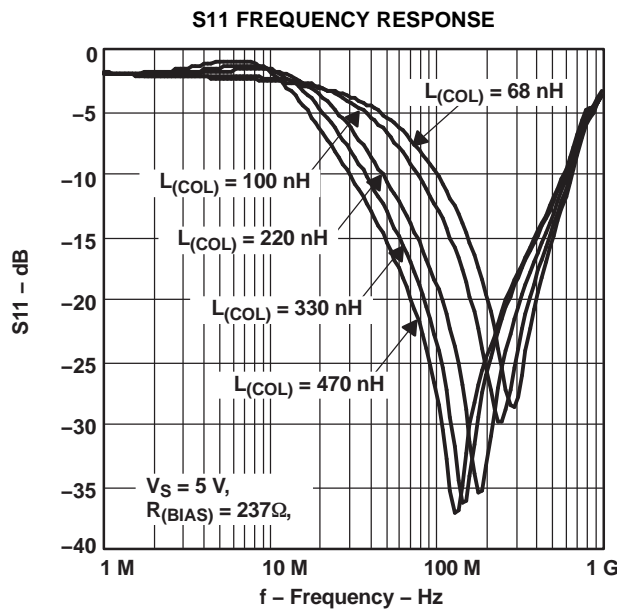

Figure 3.

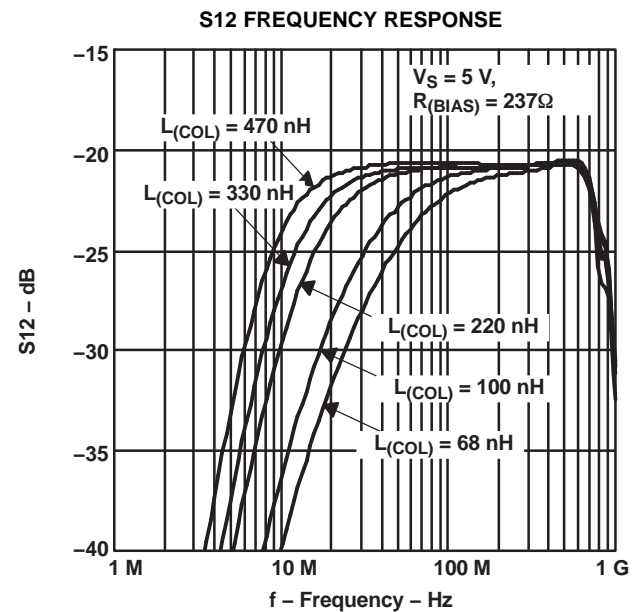

Figure 4.

S-Parameters of THS9001 as mounted on the EVM with $V_S = 3\text{ V}$ and 5 V , $R_{(BIAS)}$ = various, and $L_{(COL)} = 470\text{ nH}$ at room temp.

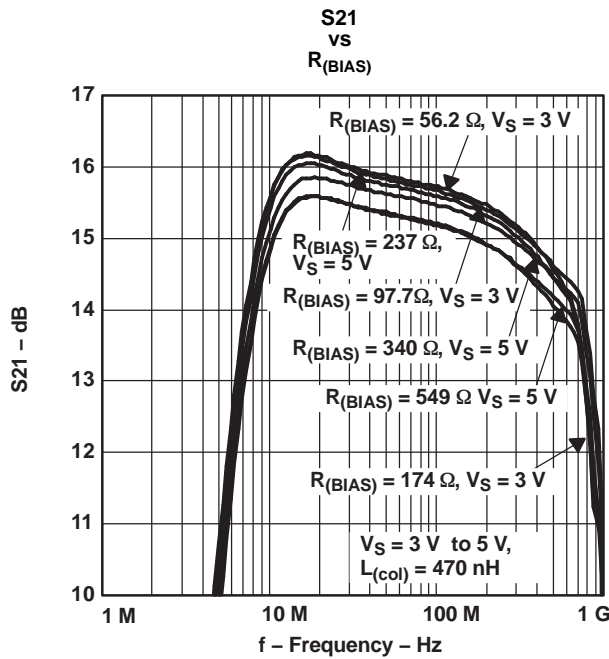

Figure 5.

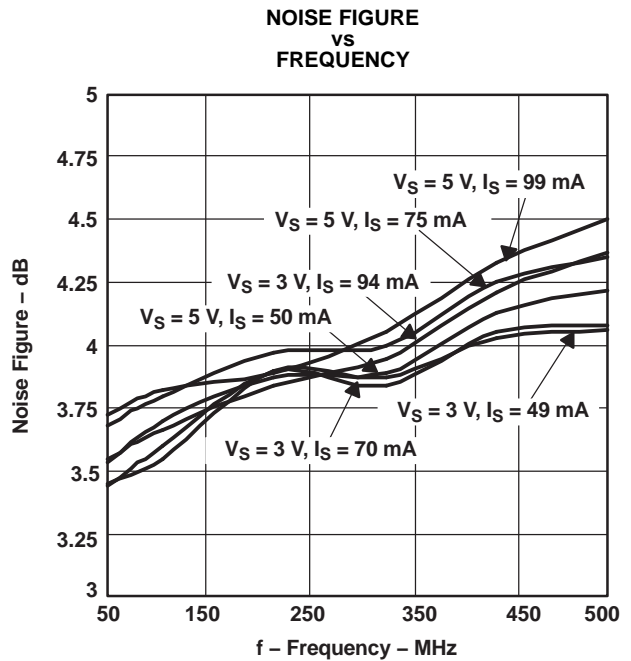

Figure 6.

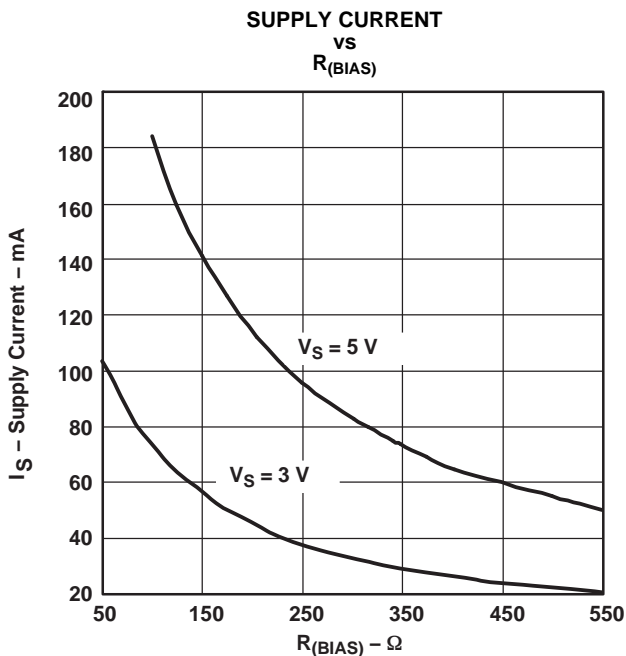

Figure 7.

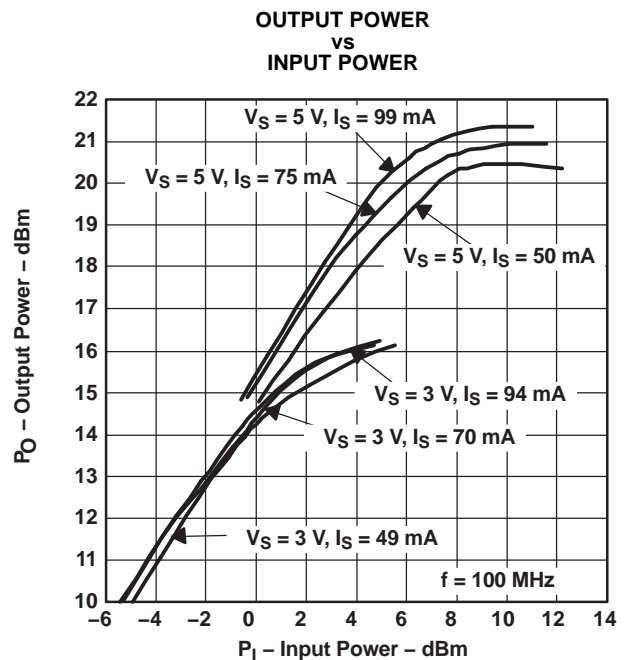

Figure 8.

ADJACENT CHANNEL (ACPR) and ALTERNATE CHANNEL (AltCPR) PROTECTION RATIOS vs INPUT POWER
 WCDMA Modulation, $f = 184.32$ MHz, PAR = 10.4 dB

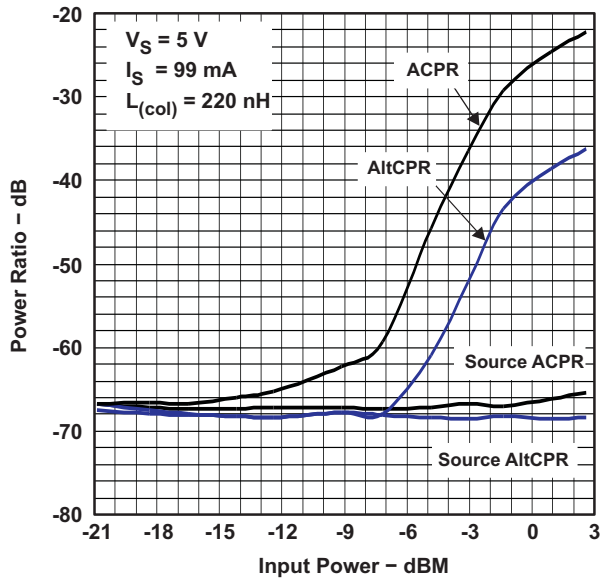

Figure 9.

OIP₂ vs FREQUENCY

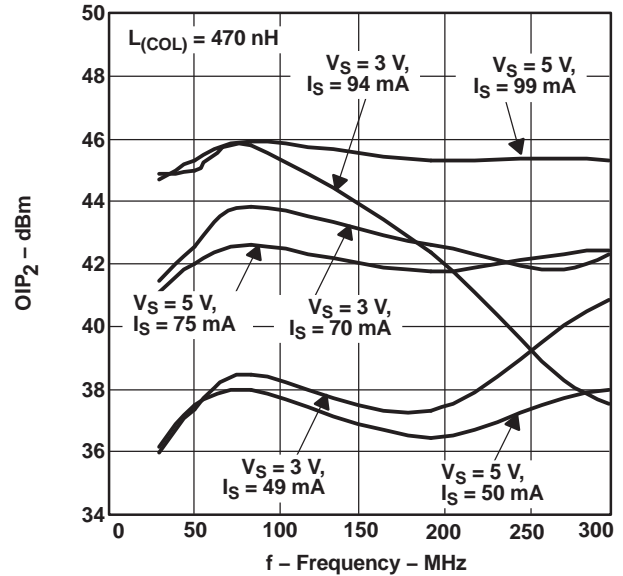

Figure 10.

OIP₃ vs FREQUENCY

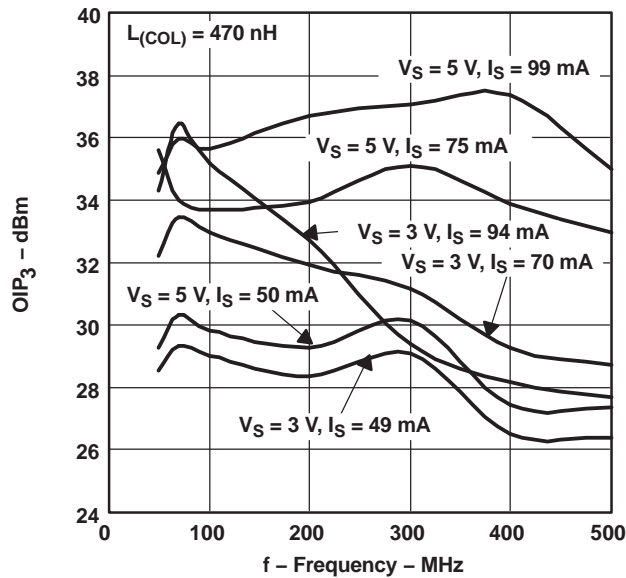

Figure 11.

THS9001 as mounted on the EVM with $V_S = 5\text{ V}$, $R_{(BIAS)} = 237\ \Omega$, and $L_{(COL)} = 470\text{ nH}$ at 40°C , 25°C , and 85°C .

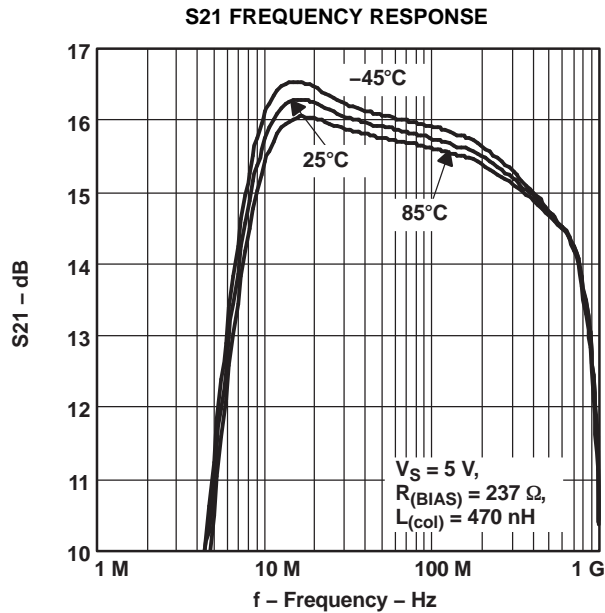

Figure 12.

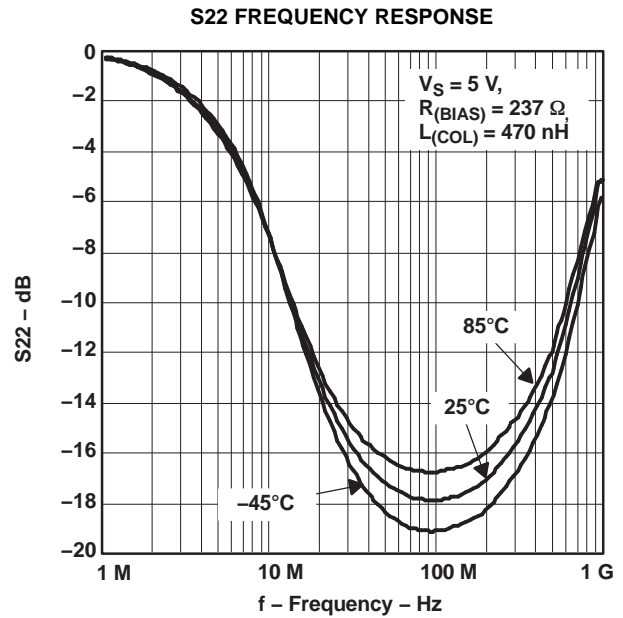

Figure 13.

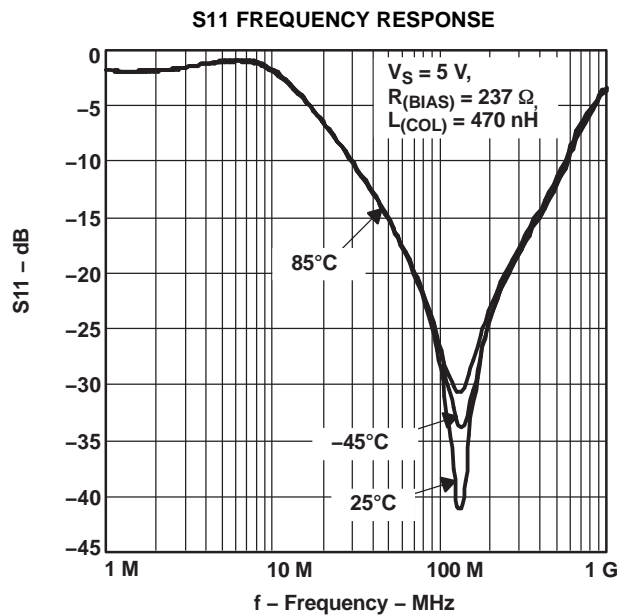

Figure 14.

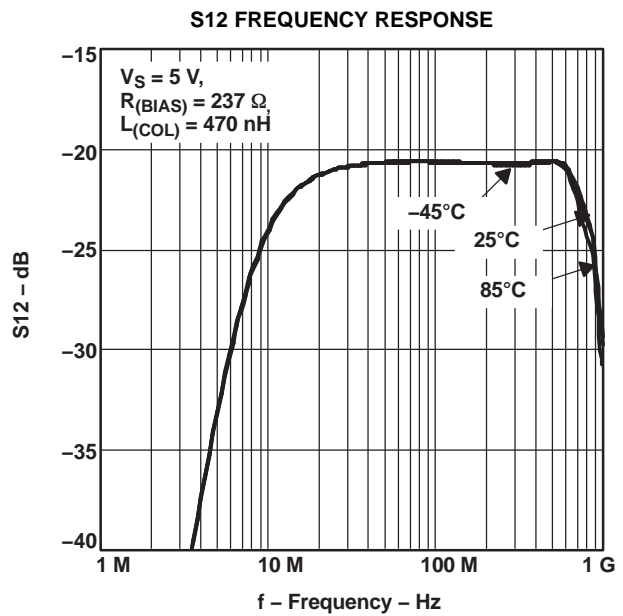

Figure 15.

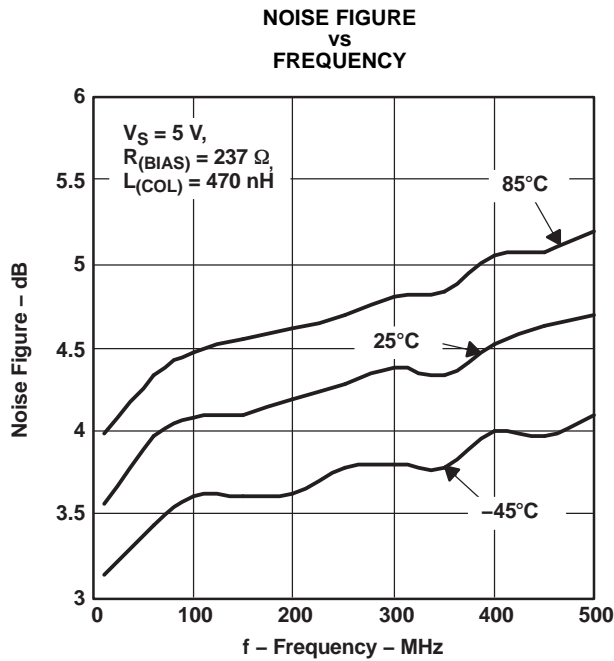

Figure 16.

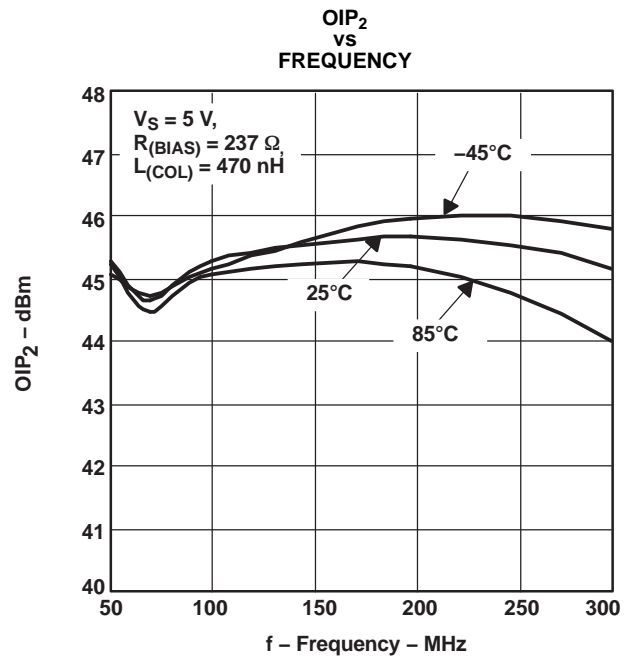

Figure 17.

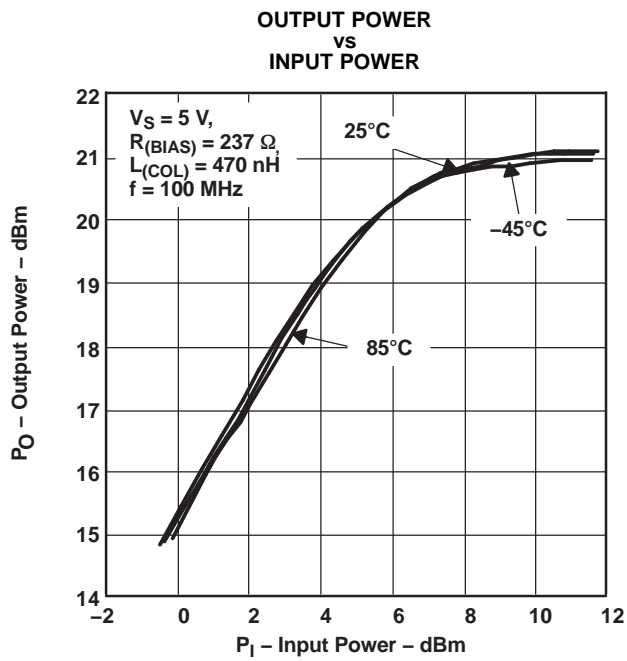

Figure 18.

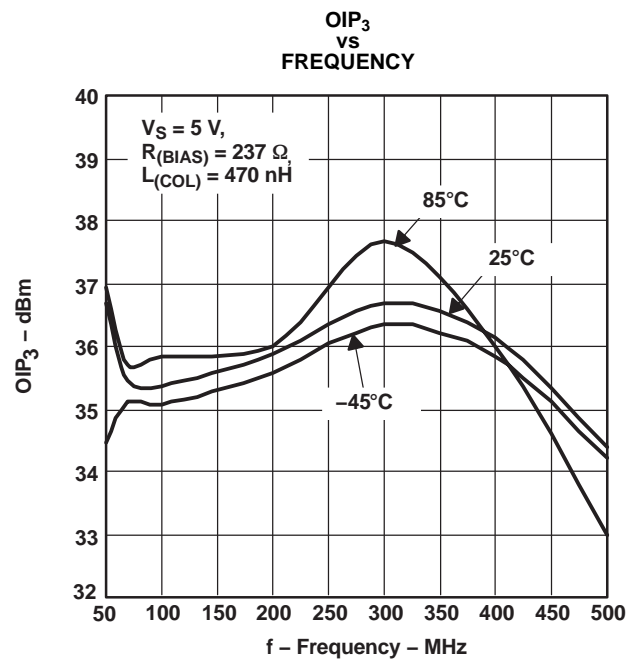

Figure 19.

TYPICAL CHARACTERISTICS

S-Parameters Tables of THS9001 with EVM De-Embedded

$V_S = 5\text{ V}$, $R_{(\text{BIAS})} = 237\ \Omega$, $L_{(\text{COL})} = 470\ \text{nH}$								
Frequency (MHz)	S21		S11		S22		S12	
	Gain (dB)	Phase (deg)	Gain (dB)	Phase (deg)	Gain (dB)	Phase (deg)	Gain (dB)	Phase (deg)
1.0	-3.5	-165.0	-2.3	-1.1	-2.6	174.8	-64.4	-121.7
5.0	11.7	-127.1	-1.5	-14.9	-2.8	140.4	-32.4	123.0
10.2	15.8	-150.1	-2.2	-42.3	-5.3	99.8	-23.6	79.5
19.7	16.3	-170.8	-6.6	-69.3	-10.7	64.5	-21.1	40.7
50.1	15.9	175.7	-16.2	-90.3	-16.2	33.9	-20.6	14.5
69.7	15.8	171.5	-21.1	-95.4	-16.9	26.4	-20.6	9.4
102.4	15.7	165.7	-32.3	-86.5	-17.1	19.9	-20.6	5.3
150.5	15.6	158.2	-28.0	45.9	-16.8	14.7	-20.7	2.1
198.1	15.5	151.1	-21.9	46.8	-16.2	10.8	-20.7	0.1
246.9	15.3	144.1	-18.9	37.2	-15.3	6.0	-20.7	-1.4
307.6	15.2	135.3	-16.0	27.8	-14.2	-1.8	-20.6	-3.9
362.8	15.0	127.8	-14.2	17.4	-13.3	-9.2	-20.6	-5.9
405.0	14.9	121.9	-12.8	10.9	-12.6	-16.0	-20.6	-8.2
452.2	14.7	115.4	-11.6	3.0	-11.8	-23.9	-20.6	-10.8
504.7	14.5	108.4	-10.3	-6.0	-10.9	-33.0	-20.7	-14.2
563.4	14.4	100.3	-8.9	-17.4	-9.8	-45.2	-20.9	-19.3
595.3	14.2	96.0	-8.2	-23.3	-9.2	-52.2	-21.0	-22.6
664.5	14.1	87.0	-6.7	-36.9	-8.0	-68.3	-21.7	-30.5
702.1	14.0	80.9	-5.9	-44.6	-7.3	-79.1	-22.5	-38.6
741.8	13.9	76.5	-5.1	-54.0	-6.8	-91.4	-24.0	-44.9
828.1	13.5	62.2	-4.3	-76.1	-6.3	-113.2	-26.5	-35.0
874.9	13.0	54.0	-4.1	-84.6	-5.9	-126.0	-27.0	-49.0
924.4	12.8	44.9	-3.6	-93.1	-5.1	-136.8	-28.0	-62.9
976.7	11.6	35.9	-3.5	-104.4	-5.3	-157.8	-34.0	-104.4
1031.9	11.1	33.0	-3.4	-115.7	-5.8	-172.3	-37.1	107.9
1090.3	10.4	29.2	-3.3	-122.0	-5.7	-173.4	-37.8	162.5
1151.9	10.3	22.2	-3.0	-131.3	-4.8	179.4	-31.1	169.5
1217.1	9.7	4.7	-2.9	-142.3	-3.9	161.9	-26.3	137.1
1285.9	8.6	0.7	-2.9	-151.7	-3.6	147.6	-22.7	121.9
1358.6	7.3	-8.3	-2.9	-161.2	-3.4	134.6	-20.6	116.5
1435.5	5.8	-14.5	-3.0	-170.1	-3.2	122.6	-18.8	105.2
1516.6	4.6	-22.7	-3.1	-178.6	-3.2	112.1	-17.2	96.0
1602.4	3.2	-28.4	-3.1	173.2	-3.1	101.7	-15.7	87.0
1693.0	1.5	-38.0	-3.1	165.1	-3.0	92.4	-14.3	79.2
1788.8	-0.5	-47.9	-3.1	157.6	-2.9	83.6	-13.1	68.8
1889.9	-2.5	-51.0	-3.2	148.8	-2.7	74.4	-12.4	56.9
1996.8	-4.1	-49.0	-3.4	139.5	-2.3	65.0	-12.2	48.2

APPLICATION INFORMATION

The THS9001 is a medium power, cascadeable, amplifier optimized for high intermediate frequencies in radios. The amplifier is unconditionally stable and design requires only 2 dc-blocking capacitors, 1 power-supply bypass capacitor, 1 RF choke, and 1 bias resistor. Refer to [Figure 25](#) for circuit diagram.

The THS9001 operates with a power supply voltage ranging from 2.5 V to 5.5 V.

The value of $R_{(BIAS)}$ sets the bias current to the amplifier. Refer to [Figure 7](#). This allows the designer to trade-off linearity versus power consumption. $R_{(BIAS)}$ can be removed without damage to the device.

Component selection of $C_{(BYP)}$, C_{IN} , and C_{OUT} is not critical. The values shown in [Figure 25](#) were used for all the data shown in this data sheet.

The amplifier incorporates internal impedance matching to 50 Ω that can be adjusted for various frequencies of operation by proper selection of $L_{(COL)}$.

[Figure 20](#) shows the s-parameters of the part mounted on the standard EVM with $V_S = 5$ V, $R_{(BIAS)} = 237 \Omega$, and $L_{(COL)} = 470$ nH. With this configuration, the part is very broadband, and achieves greater than 15-dB input and output return loss from 50 MHz to 325 MHz.

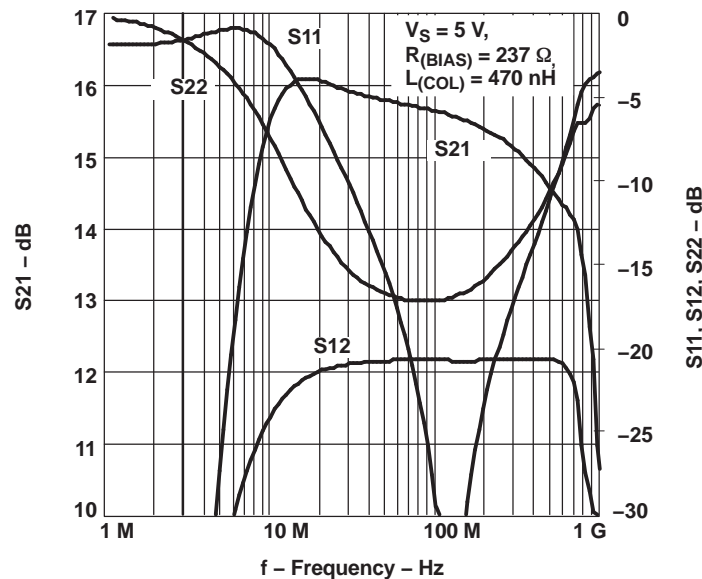

Figure 20. S-Parameters of THS9001 Mounted on the Standard EVM With $V_S = 5$ V, $R_{(BIAS)} = 237 \Omega$, and $L_{(COL)} = 470$ nH

APPLICATION INFORMATION (continued)

Figure 21 Shows an example of a single conversion receiver architecture and where the THS9001 would typically be used.

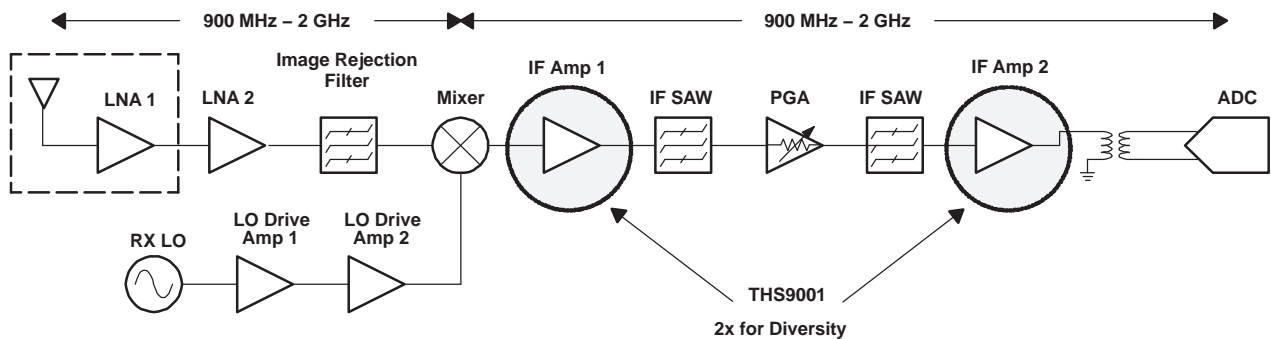

Figure 21. Example Single Conversion Receiver Architecture

Figure 22 shows an example of a dual conversion receiver architecture and where the THS9001 would typically be used.

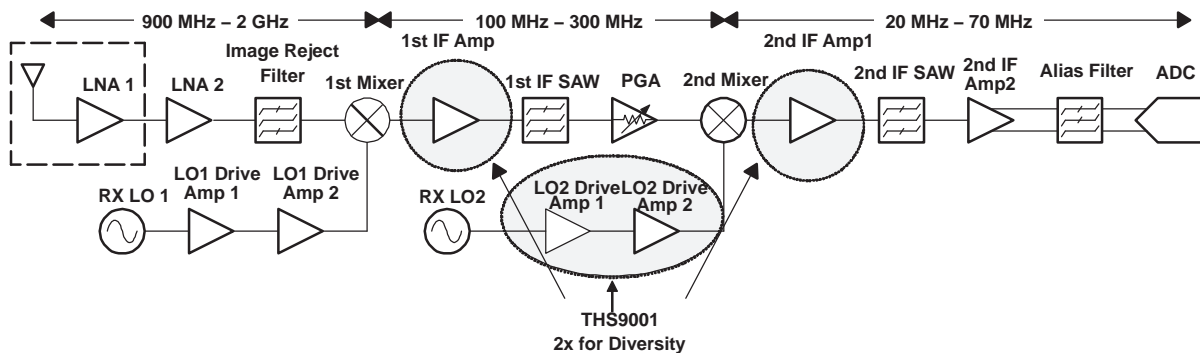

Figure 22. Example Dual Conversion Receiver Architecture

Figure 23 shows an example of a dual conversion transmitter architecture and where the THS9001 would typically be used.

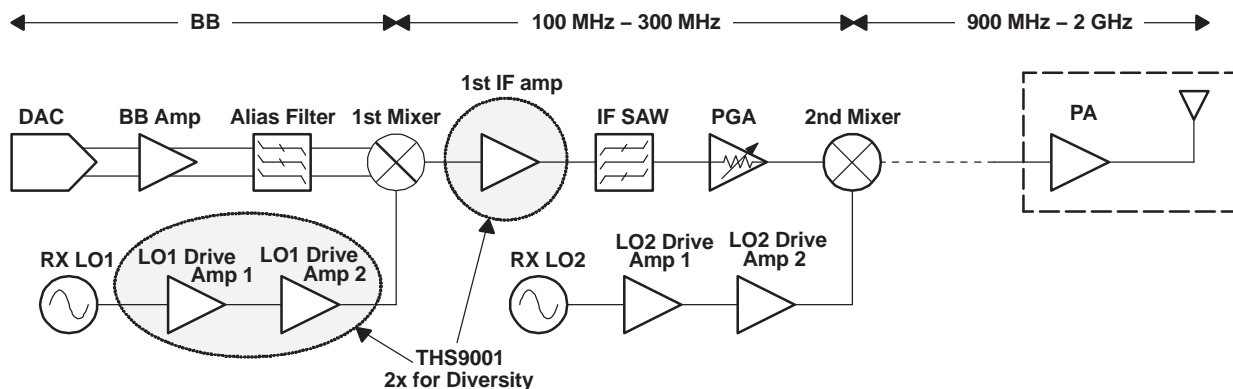
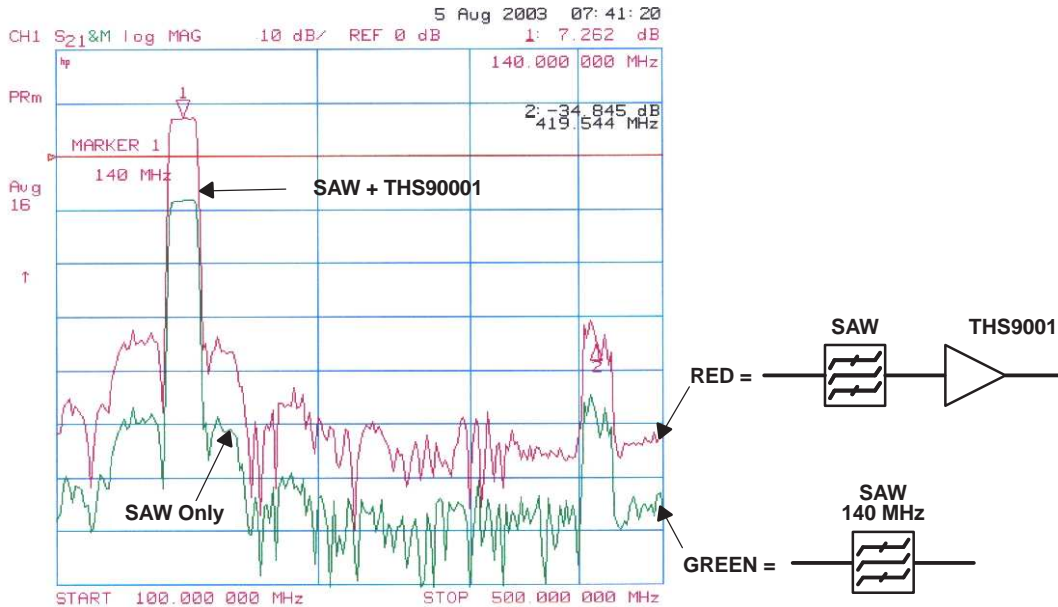

Figure 23. Example Dual Conversion Transmitter Architecture

APPLICATION INFORMATION (continued)

Figure 24 shows the THS9001 and Sawtek #854916 SAW filter frequency response along with the frequency response of the SAW filter alone. The SAW filter has a center frequency of 140 MHz with 10-MHz bandwidth and 8-dB insertion loss. It can be seen that the frequency response with the THS9001 is the same as with the SAW except for a 15-dB gain. The THS9001 is mounted on the standard EVM with $V_S = 5\text{ V}$, $R_{(BIAS)} = 237\ \Omega$, and $L_{(COL)} = 470\text{ nH}$. Note the amplifier does not add artifacts to the signal.



140 MHz SAW: Sawtek #854916

Figure 24. Frequency Response of the THS9001 and SAW Filter, and SAW Filter Only

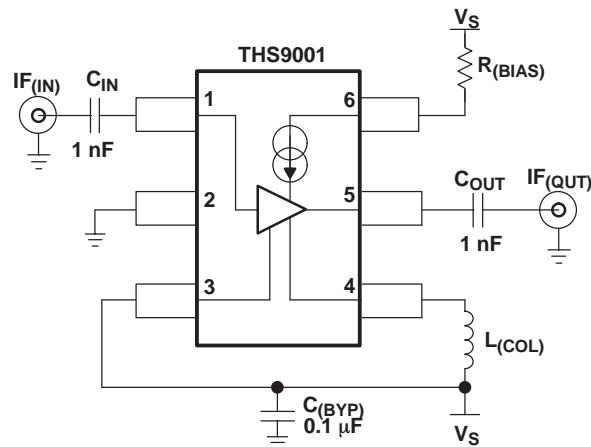

Figure 25. THS9001 Recommended Circuit (Used for all Tests)

APPLICATION INFORMATION (continued)

Evaluation Module

Table 1 is the bill of materials, and [Figure 26](#) and [Figure 27](#) show the EVM layout.

Bill Of Materials

ITEM	DESCRIPTION	REF DES	QTY	PART NUMBER ⁽¹⁾
1	Cap, 0.1 μ F, ceramic, X7R, 50 V	C1	1	(AVX) 08055C104KAT2A
2	Cap, 1000 pF, ceramic, NPO, 100 V	C2, C3	2	(AVX) 08051A102JAT2A
3	Inductor, 470 nH, 5%	L1	1	(Coilcraft) 0805CS-471XJBC
4	Resistor, 237 Ω , 1/8 W, 1%	R1	1	(Phycomp) 9C08052A2370FKHFT
5	Open	TR1	1	
6	Jack, banana receptance, 0.25" dia.	J3, J4	2	(SPC) 813
7	Connector, edge, SMA PCB jack	J1, J2	2	(Johnson) 142-0701-801
8	Standoff, 4-40 Hex, 0.625" Length		4	(KEYSTONE) 1808
9	Screw, Phillips, 4-40, .250"		4	SHR-0440-016-SN
10	IC, THS9001	U1	1	(TI) THS9001DBV
11	Board, printed-circuit		1	(TI) EDGE # 6453522 Rev.A

(1) The manufacturer's part numbers are used for test purposes only.

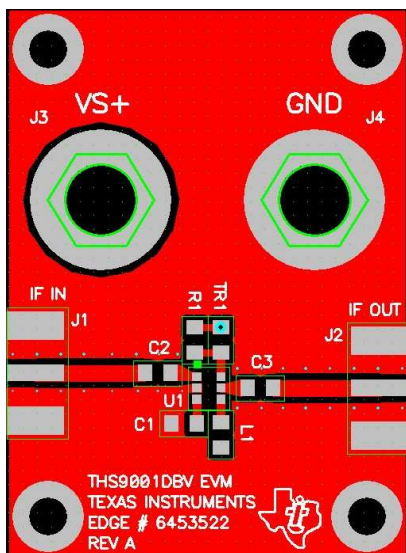

Figure 26. EVM Top Layout

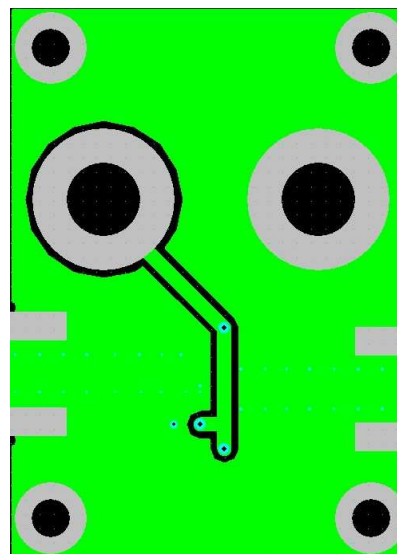
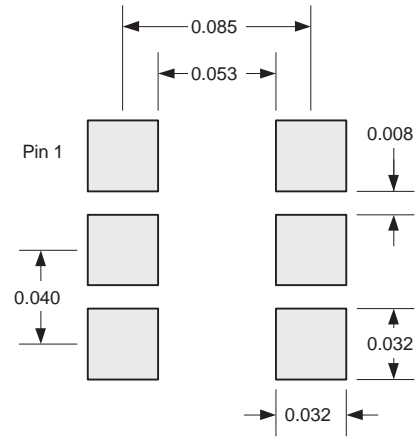

Figure 27. EVM Bottom Layout



Top View

Figure 28. THS9001 Recommended Footprint (dimensions in inches)

PACKAGING INFORMATION

Orderable Device	Status ⁽¹⁾	Package Type	Package Drawing	Pins	Package Qty	Eco Plan ⁽²⁾	Lead/Ball Finish	MSL Peak Temp ⁽³⁾
THS9001DBVR	ACTIVE	SOT-23	DBV	6	3000	Green (RoHS & no Sb/Br)	CU NIPDAU	Level-1-260C-UNLIM
THS9001DBVRG4	ACTIVE	SOT-23	DBV	6	3000	Green (RoHS & no Sb/Br)	CU NIPDAU	Level-1-260C-UNLIM
THS9001DBVT	ACTIVE	SOT-23	DBV	6	250	Green (RoHS & no Sb/Br)	CU NIPDAU	Level-1-260C-UNLIM
THS9001DBVTG4	ACTIVE	SOT-23	DBV	6	250	Green (RoHS & no Sb/Br)	CU NIPDAU	Level-1-260C-UNLIM

⁽¹⁾ The marketing status values are defined as follows:

ACTIVE: Product device recommended for new designs.

LIFEBUY: TI has announced that the device will be discontinued, and a lifetime-buy period is in effect.

NRND: Not recommended for new designs. Device is in production to support existing customers, but TI does not recommend using this part in a new design.

PREVIEW: Device has been announced but is not in production. Samples may or may not be available.

OBSOLETE: TI has discontinued the production of the device.

⁽²⁾ Eco Plan - The planned eco-friendly classification: Pb-Free (RoHS), Pb-Free (RoHS Exempt), or Green (RoHS & no Sb/Br) - please check <http://www.ti.com/productcontent> for the latest availability information and additional product content details.

TBD: The Pb-Free/Green conversion plan has not been defined.

Pb-Free (RoHS): TI's terms "Lead-Free" or "Pb-Free" mean semiconductor products that are compatible with the current RoHS requirements for all 6 substances, including the requirement that lead not exceed 0.1% by weight in homogeneous materials. Where designed to be soldered at high temperatures, TI Pb-Free products are suitable for use in specified lead-free processes.

Pb-Free (RoHS Exempt): This component has a RoHS exemption for either 1) lead-based flip-chip solder bumps used between the die and package, or 2) lead-based die adhesive used between the die and leadframe. The component is otherwise considered Pb-Free (RoHS compatible) as defined above.

Green (RoHS & no Sb/Br): TI defines "Green" to mean Pb-Free (RoHS compatible), and free of Bromine (Br) and Antimony (Sb) based flame retardants (Br or Sb do not exceed 0.1% by weight in homogeneous material)

⁽³⁾ MSL, Peak Temp. -- The Moisture Sensitivity Level rating according to the JEDEC industry standard classifications, and peak solder temperature.

Important Information and Disclaimer:The information provided on this page represents TI's knowledge and belief as of the date that it is provided. TI bases its knowledge and belief on information provided by third parties, and makes no representation or warranty as to the accuracy of such information. Efforts are underway to better integrate information from third parties. TI has taken and continues to take reasonable steps to provide representative and accurate information but may not have conducted destructive testing or chemical analysis on incoming materials and chemicals. TI and TI suppliers consider certain information to be proprietary, and thus CAS numbers and other limited information may not be available for release.

In no event shall TI's liability arising out of such information exceed the total purchase price of the TI part(s) at issue in this document sold by TI to Customer on an annual basis.

TAPE AND REEL INFORMATION



QUADRANT ASSIGNMENTS FOR PIN 1 ORIENTATION IN TAPE



*All dimensions are nominal

Device	Package Type	Package Drawing	Pins	SPQ	Reel Diameter (mm)	Reel Width W1 (mm)	A0 (mm)	B0 (mm)	K0 (mm)	P1 (mm)	W (mm)	Pin1 Quadrant
THS9001DBVR	SOT-23	DBV	6	3000	180.0	9.0	3.15	3.2	1.4	4.0	8.0	Q3
THS9001DBVT	SOT-23	DBV	6	250	180.0	9.0	3.15	3.2	1.4	4.0	8.0	Q3

TAPE AND REEL BOX DIMENSIONS



*All dimensions are nominal

Device	Package Type	Package Drawing	Pins	SPQ	Length (mm)	Width (mm)	Height (mm)
THS9001DBVR	SOT-23	DBV	6	3000	182.0	182.0	20.0
THS9001DBVT	SOT-23	DBV	6	250	182.0	182.0	20.0

DBV (R-PDSO-G6)

PLASTIC SMALL-OUTLINE PACKAGE



- NOTES:
- A. All linear dimensions are in millimeters.
 - B. This drawing is subject to change without notice.
 - C. Body dimensions do not include mold flash or protrusion. Mold flash and protrusion shall not exceed 0.15 per side.
 - D. Leads 1,2,3 may be wider than leads 4,5,6 for package orientation.
- \triangle Falls within JEDEC MO-178 Variation AB, except minimum lead width.

IMPORTANT NOTICE

Texas Instruments Incorporated and its subsidiaries (TI) reserve the right to make corrections, modifications, enhancements, improvements, and other changes to its products and services at any time and to discontinue any product or service without notice. Customers should obtain the latest relevant information before placing orders and should verify that such information is current and complete. All products are sold subject to TI's terms and conditions of sale supplied at the time of order acknowledgment.

TI warrants performance of its hardware products to the specifications applicable at the time of sale in accordance with TI's standard warranty. Testing and other quality control techniques are used to the extent TI deems necessary to support this warranty. Except where mandated by government requirements, testing of all parameters of each product is not necessarily performed.

TI assumes no liability for applications assistance or customer product design. Customers are responsible for their products and applications using TI components. To minimize the risks associated with customer products and applications, customers should provide adequate design and operating safeguards.

TI does not warrant or represent that any license, either express or implied, is granted under any TI patent right, copyright, mask work right, or other TI intellectual property right relating to any combination, machine, or process in which TI products or services are used. Information published by TI regarding third-party products or services does not constitute a license from TI to use such products or services or a warranty or endorsement thereof. Use of such information may require a license from a third party under the patents or other intellectual property of the third party, or a license from TI under the patents or other intellectual property of TI.

Reproduction of TI information in TI data books or data sheets is permissible only if reproduction is without alteration and is accompanied by all associated warranties, conditions, limitations, and notices. Reproduction of this information with alteration is an unfair and deceptive business practice. TI is not responsible or liable for such altered documentation. Information of third parties may be subject to additional restrictions.

Resale of TI products or services with statements different from or beyond the parameters stated by TI for that product or service voids all express and any implied warranties for the associated TI product or service and is an unfair and deceptive business practice. TI is not responsible or liable for any such statements.

TI products are not authorized for use in safety-critical applications (such as life support) where a failure of the TI product would reasonably be expected to cause severe personal injury or death, unless officers of the parties have executed an agreement specifically governing such use. Buyers represent that they have all necessary expertise in the safety and regulatory ramifications of their applications, and acknowledge and agree that they are solely responsible for all legal, regulatory and safety-related requirements concerning their products and any use of TI products in such safety-critical applications, notwithstanding any applications-related information or support that may be provided by TI. Further, Buyers must fully indemnify TI and its representatives against any damages arising out of the use of TI products in such safety-critical applications.

TI products are neither designed nor intended for use in military/aerospace applications or environments unless the TI products are specifically designated by TI as military-grade or "enhanced plastic." Only products designated by TI as military-grade meet military specifications. Buyers acknowledge and agree that any such use of TI products which TI has not designated as military-grade is solely at the Buyer's risk, and that they are solely responsible for compliance with all legal and regulatory requirements in connection with such use.

TI products are neither designed nor intended for use in automotive applications or environments unless the specific TI products are designated by TI as compliant with ISO/TS 16949 requirements. Buyers acknowledge and agree that, if they use any non-designated products in automotive applications, TI will not be responsible for any failure to meet such requirements.

Following are URLs where you can obtain information on other Texas Instruments products and application solutions:

Products

Amplifiers	amplifier.ti.com
Data Converters	dataconverter.ti.com
DSP	dsp.ti.com
Clocks and Timers	www.ti.com/clocks
Interface	interface.ti.com
Logic	logic.ti.com
Power Mgmt	power.ti.com
Microcontrollers	microcontroller.ti.com
RFID	www.ti-rfid.com
RF/IF and ZigBee® Solutions	www.ti.com/lprf

Applications

Audio	www.ti.com/audio
Automotive	www.ti.com/automotive
Broadband	www.ti.com/broadband
Digital Control	www.ti.com/digitalcontrol
Medical	www.ti.com/medical
Military	www.ti.com/military
Optical Networking	www.ti.com/opticalnetwork
Security	www.ti.com/security
Telephony	www.ti.com/telephony
Video & Imaging	www.ti.com/video
Wireless	www.ti.com/wireless

Mailing Address: Texas Instruments, Post Office Box 655303, Dallas, Texas 75265
Copyright © 2008, Texas Instruments Incorporated