

Description

The new 0805L series device provides surface mount overcurrent protection for applications where space is at a premium and resettable protection is desired.

Features

- RoHS compliant and lead-free
- Fast response to fault currents
- Compact design saves board space
- Low resistance
- Low-profile
- Compatible with high temperature solders

Agency Approvals

AGENCY	AGENCY FILE NUMBER
	E183209
	R50082521

Applications

- USB peripherals
- Disk drives
- CD-ROMs
- Plug and play protection for motherboards and peripherals
- Mobile phones - battery and port protection
- Disk drives
- PDAs / digital cameras
- Game console port protection

Electrical Characteristics

Part Number	Marking	I _{hold} (A)	I _{trip} (A)	V _{max} (Vdc)	I _{max} (A)	P _d max. (W)	Maximum Time To Trip		Resistance			Agency Approvals	
							Current (A)	Time (Sec.)	R _{min} (Ω)	R _{typ} (Ω)	R _{1max} (Ω)		
0805L010	A	0.10	0.30	15	100	0.5	0.50	1.50	1.000	3.500	6.000	X	X
0805L020	C	0.20	0.50	9	100	0.5	8.00	0.02	0.650	2.000	3.500	X	X
0805L035	E	0.35	0.75	6	100	0.5	8.00	0.10	0.250	0.750	1.200	X	X
0805L050	F	0.50	1.00	6	100	0.5	8.00	0.10	0.150	0.500	0.850	X	X
0805L075	G	0.75	1.50	6	40	0.6	8.00	0.20	0.090	–	0.350	X	X
0805L100	N	1.0	1.95	6	40	0.6	8.00	0.30	0.060	–	0.210	X	X

I_{hold} = Hold current: maximum current device will pass without tripping in 20°C still air.

I_{trip} = Trip current: minimum current at which the device will trip in 20°C still air.

V_{max} = Maximum voltage device can withstand without damage at rated current (I_{max})

I_{max} = Maximum fault current device can withstand without damage at rated voltage (V_{max})

P_d = Power dissipated from device when in the tripped state at 20°C still air.

R_{min} = Minimum resistance of device in initial (un-soldered) state.

R_{typ} = Typical resistance of device in initial (un-soldered) state.

R_{1max} = Maximum resistance of device at 20°C measured one hour after tripping or reflow soldering of 260°C for 20 sec.

Caution: Operation beyond the specified rating may result in damage and possible arcing and flame.

Temperature Derating

Part Number	Ambient Operation Temperature								
	-40°C	-20°C	0°C	23°C	40°C	50°C	60°C	70°C	85°C
0805L010	0.14	0.12	0.11	0.10	0.08	0.07	0.06	0.05	0.03
0805L020	0.28	0.25	0.23	0.20	0.17	0.14	0.12	0.10	0.07
0805L035	0.47	0.44	0.39	0.35	0.30	0.27	0.24	0.20	0.14
0805L050	0.68	0.62	0.55	0.50	0.40	0.37	0.33	0.29	0.23
0805L075	1.00	0.90	0.79	0.75	0.63	0.57	0.53	0.41	0.34
0805L100	1.35	1.25	1.10	1.00	0.82	0.74	0.65	0.55	0.42

Average Time Current Curves

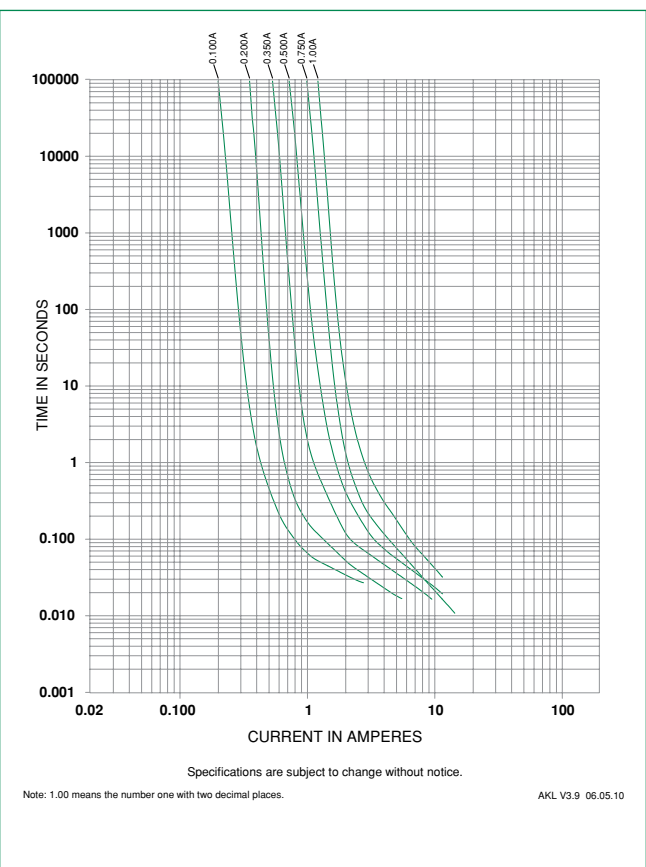

Temperature Derating Curve

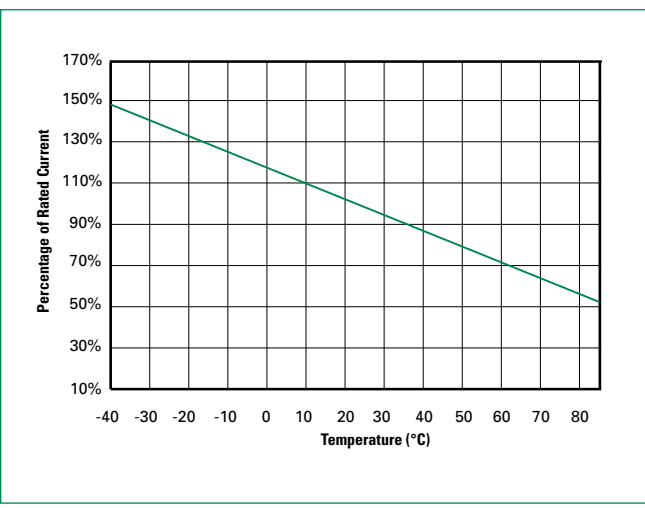

The average time current curves and temperature derating curve performance is affected by a number of variables, and these curves provided as guidance only. Customer must verify the performance in their application.

Soldering Parameters

Condition	Reflow
Peak Temp/ Duration Time	260°C / 10 Sec
Time above liquids (TAL) 220°C	60 Sec ~ 100 Sec
Preheat 120°C~ 180°C	50 Sec ~ 150 Sec
Storage Condition	0°C~35°C, ≤70%RH

- Recommended reflow methods: IR, vapor phase oven, hot air oven, N₂ environment for lead-free
- Devices are not designed to be wave soldered to the bottom side of the board.
- Recommended maximum paste thickness is 0.25mm (0.010 inch)
- Devices can be cleaned using standard industry methods and solvents.

Note: If reflow temperatures exceed the recommended profile, devices may not meet the performance requirements.

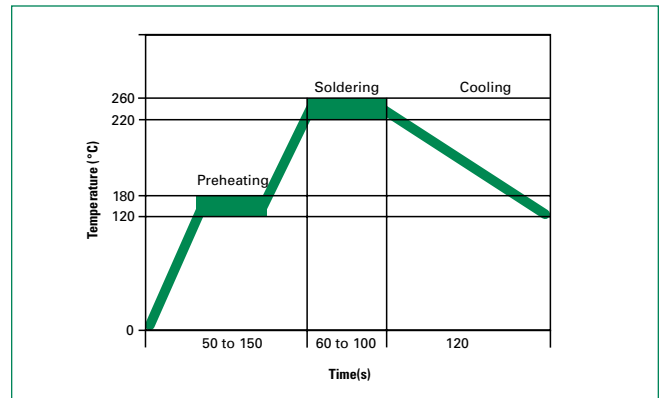
Physical Specifications

Terminal Material	Gold-Plated Copper or Solder-Plated Copper (Solder Material: Matte Tin (Sn))
Lead Solderability	Meets EIA Specification RS186-9E, ANSI/J-STD-002 Category 3.

Environmental Specifications

Operating/Storage Temperature	-40°C to +85°C
Maximum Device Surface Temperature in Tripped State	125°C
Passive Aging	+85°C, 1000 hours ±5% typical resistance change
Humidity Aging	+85°C, 85% R.H. 1000 hours ±5% typical resistance change
Thermal Shock	MIL-STD-202 Method 107G +85°C/-40°C 20 times -30% typical resistance change
Solvent Resistance	MIL-STD-202, Method 215 No change
Vibration	MIL-STD-883C, Method 2007.1, Condition A No change

Dimensions

MARKING CODE VARIES
WITH AMPERAGE RATING
(SEE CHART)
SHOWN IS 1.0AMP RATING

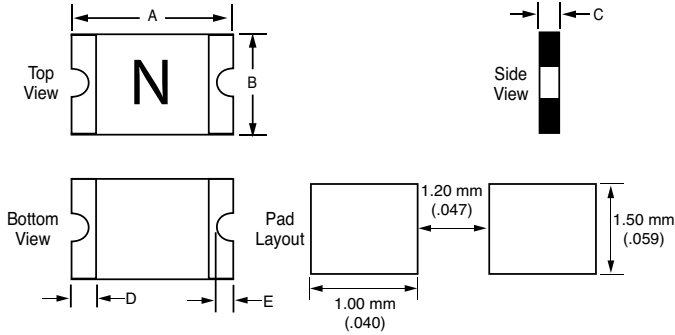

Part Number	A				B				C				D		E			
	Inches		mm		Inches		mm		Inches		mm		Inches	mm	Inches	mm	Inches	mm
	Min.	Max.	Min.	Max.	Min.	Max.	Min.	Max.	Min.	Max.	Min.	Max.	Min.	Min.	Min.	Max.	Min.	Max.
0805L010	0.08	0.09	2.00	2.20	0.05	0.06	1.20	1.50	0.02	0.04	0.55	1.00	0.01	0.20	0.004	0.02	0.10	0.45
0805L020	0.08	0.09	2.00	2.20	0.05	0.06	1.20	1.50	0.02	0.04	0.55	1.00	0.01	0.20	0.004	0.02	0.10	0.45
0805L035	0.08	0.09	2.00	2.20	0.05	0.06	1.20	1.50	0.02	0.03	0.45	0.75	0.01	0.20	0.004	0.02	0.10	0.45
0805L050	0.08	0.09	2.00	2.20	0.05	0.06	1.20	1.50	0.03	0.05	0.75	1.25	0.01	0.20	0.004	0.02	0.10	0.45
0805L075	0.08	0.09	2.00	2.20	0.05	0.06	1.20	1.50	0.03	0.05	0.75	1.25	0.01	0.20	0.006	0.02	0.15	0.45
0805L100	0.08	0.09	2.00	2.20	0.05	0.06	1.20	1.50	0.03	0.07	0.80	1.80	0.01	0.20	0.006	0.02	0.15	0.45

Part Numbering System

0805 L 100 W R

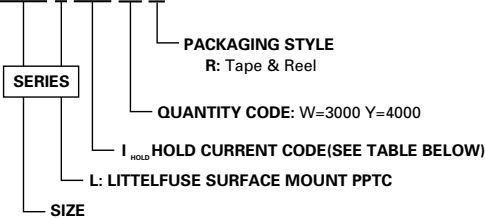

Packaging

I_{hold} (A)	I_{hold} Code	Packaging Option	Quantity	Quantity & Packaging Codes
0.10	010	Tape and Reel	4000	YR
0.20	020	Tape and Reel	4000	YR
0.35	035	Tape and Reel	4000	YR
0.50	050	Tape and Reel	3000	WR
0.75	075	Tape and Reel	3000	WR
1.00	100	Tape and Reel	3000	WR



Description

The 1206L series device provides surface mount overcurrent protection for applications where space is at a premium and resettable protection is desired.

Features

- RoHS compliant and lead-free
- Fast response to fault currents
- Compact design saves board space
- Low resistance
- Low-profile
- Compatible with high temperature solders

Agency Approvals

AGENCY	AGENCY FILE NUMBER
	E183209
	R50082521

Applications

- USB peripherals
- Disk drives
- CD-ROMs
- Plug and play protection for motherboards and peripherals
- Mobile phones - battery and port protection
- Disk drives
- PDAs / digital cameras
- Game console port protection

Electrical Characteristics

Part Number	Marking	I _{hold} (A)	I _{trip} (A)	V _{max} (Vdc)	I _{max} (A)	P _{d max.} (W)	Maximum Time To Trip		Resistance			Agency Approvals	
							Current (A)	Time (Sec.)	R _{min} (Ω)	R _{typ} (Ω)	R _{1max} (Ω)		
1206L012	A	0.125	0.29	30	100	0.6	1.00	0.20	1.500	3.600	6.000	X	X
1206L016	B	0.16	0.37	30	100	0.6	1.00	0.30	1.200	2.800	4.500	X	X
1206L020-C	C	0.20	0.42	24	100	0.6	8.00	0.10	0.650	1.550	2.600	X	X
1206L025-C	D	0.25	0.50	16	100	0.6	8.00	0.08	0.550	1.400	2.300	X	X
1206L035-C	E	0.35	0.75	6	100	0.6	8.00	0.10	0.300	0.750	1.200	X	X
1206L035/16	J	0.35	0.75	16	100	0.6	8.00	0.10	0.300	0.750	1.200	X	X
1206L050-C	F	0.50	1.00	6	100	0.6	8.00	0.10	0.150	0.400	0.700	X	X
1206L050/15	M	0.50	1.00	15	100	0.6	8.00	0.10	0.150	0.400	0.750	X	X
1206L075-C	G	0.75	1.50	6	100	0.6	8.00	0.20	0.090	0.200	0.290	X	X
1206L100	N	1.00	1.80	6	100	0.8	8.00	0.30	0.055	0.110	0.210	X	X
1206L110-C	H	1.10	2.20	6	100	0.8	8.00	0.30	0.040	0.110	0.180	X	X
1206L150-C	K	1.50	3.00	6	100	0.8	8.00	1.00	0.040	0.080	0.120	X	X

I_{hold} = Hold current: maximum current device will pass without tripping in 20°C still air.

I_{trip} = Trip current: minimum current at which the device will trip in 20°C still air.

V_{max} = Maximum voltage device can withstand without damage at rated current (I_{max})

I_{max} = Maximum fault current device can withstand without damage at rated voltage (V_{max})

P_d = Power dissipated from device when in the tripped state at 20°C still air.

R_{min} = Minimum resistance of device in initial (un-soldered) state.

R_{typ} = Typical resistance of device in initial (un-soldered) state.

R_{1max} = Maximum resistance of device at 20°C measured one hour after tripping or reflow soldering of 260°C for 20 sec.

Caution: Operation beyond the specified rating may result in damage and possible arcing and flame.

Temperature Derating

Part Number	Ambient Operation Temperature								
	-40°C	-20°C	0°C	23°C	40°C	50°C	60°C	70°C	85°C
1206L012	0.18	0.16	0.14	0.125	0.10	0.09	0.08	0.07	0.05
1206L016	0.22	0.20	0.18	0.16	0.14	0.12	0.10	0.09	0.08
1206L020-C	0.28	0.25	0.23	0.20	0.17	0.15	0.14	0.12	0.09
1206L025-C	0.37	0.33	0.29	0.25	0.22	0.20	0.17	0.15	0.12
1206L035-C	0.50	0.45	0.40	0.35	0.30	0.27	0.24	0.21	0.15
1206L035/16	0.50	0.45	0.40	0.35	0.30	0.27	0.24	0.21	0.15
1206L050-C	0.71	0.64	0.57	0.50	0.42	0.39	0.35	0.31	0.25
1206L050/15	0.71	0.64	0.57	0.50	0.42	0.39	0.35	0.31	0.25
1206L075-C	1.14	1.01	0.88	0.75	0.65	0.59	0.54	0.49	0.41
1206L100	1.45	1.31	1.15	1.00	0.84	0.77	0.69	0.61	0.48
1206L110-C	1.52	1.37	1.25	1.1	0.92	0.82	0.75	0.64	0.52
1206L150-C	2.18	1.94	1.72	1.50	1.28	1.17	1.06	0.96	0.77

Average Time Current Curves

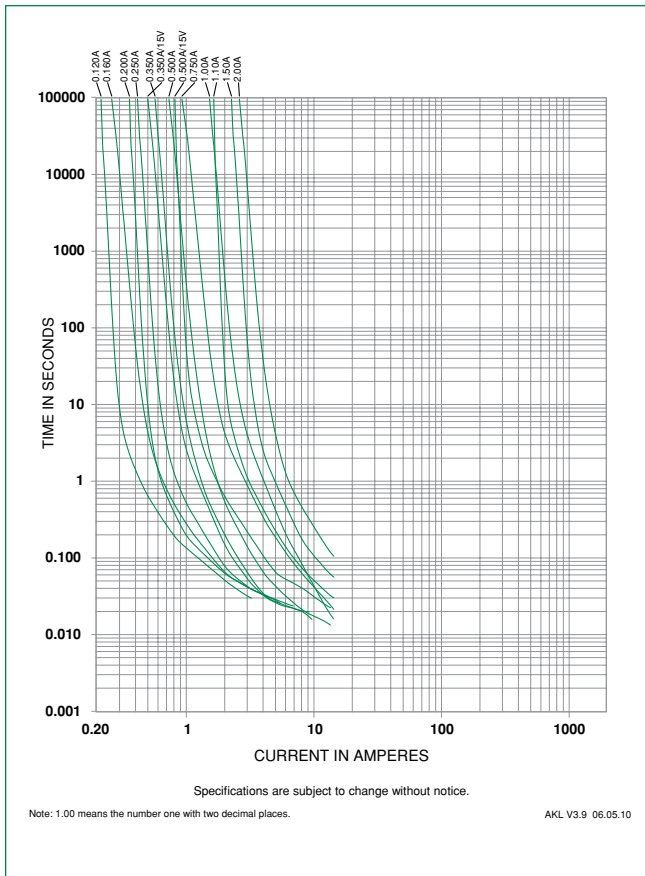

Temperature Derating Curve

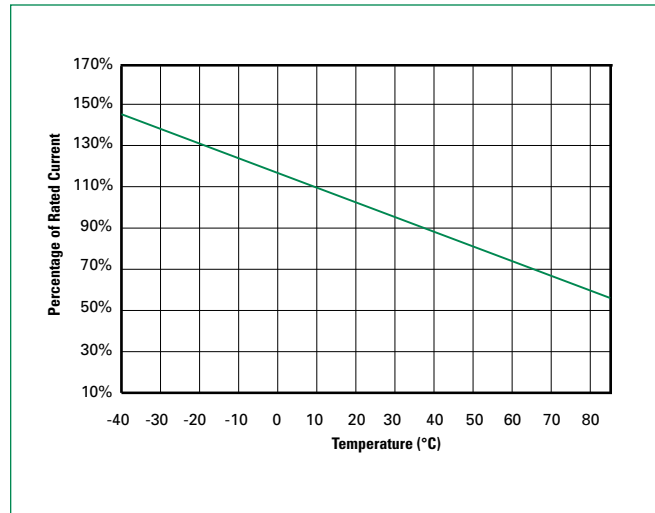

The average time current curves and temperature derating curve performance is affected by a number of variables, and these curves provided as guidance only. Customer must verify the performance in their application.

Soldering Parameters

Condition	Reflow
Peak Temp/ Duration Time	260°C / 10 Sec
Time above liquids (TAL) 220°C	60 Sec ~ 100 Sec
Preheat 120°C~ 180°C	50 Sec ~ 150 Sec
Storage Condition	0°C~35°C, 70%RH

- Recommended reflow methods: IR, vapor phase oven, hot air oven, N2 environment for lead-free
- Devices are not designed to be wave soldered to the bottom side of the board.
- Recommended maximum paste thickness is 0.25mm (0.010 inch)
- Devices can be cleaned using standard industry methods and solvents.

Note: If reflow temperatures exceed the recommended profile, devices may not meet the performance requirements.

Physical Specifications

Terminal Material	Solder-Plated Copper (Solder Material: Matte Tin (Sn))
Lead Solderability	Meets EIA Specification RS186-9E, ANSI/J-STD-002 Category 3.

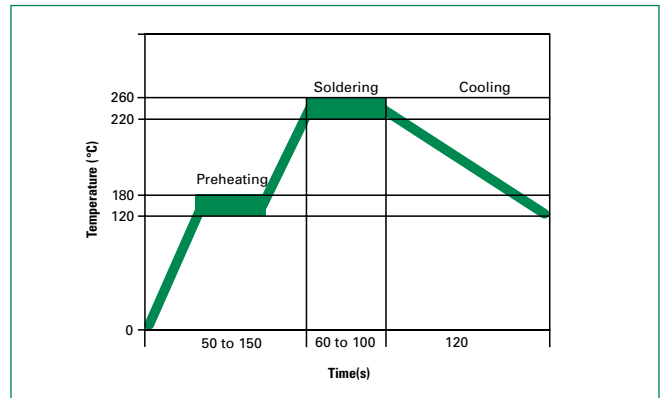
Environmental Specifications

Operating/Storage Temperature	-40°C to +85°C
Maximum Device Surface Temperature in Tripped State	125°C
Passive Aging	+85°C, 1000 hours ±5% typical resistance change
Humidity Aging	+85°C, 85% R.H. 1000 hours ±5% typical resistance change
Thermal Shock	MIL-STD-202 Method 107G +85°C/-40°C 20 times -30% typical resistance change
Solvent Resistance	MIL-STD-202, Method 215 No change
Vibration	MIL-STD-883C, Method 2007.1, Condition A No change

Dimensions

MARKING CODE VARIES WITH AMPERAGE RATING (SEE CHART)
SHOWN IS 1.6AMP RATING

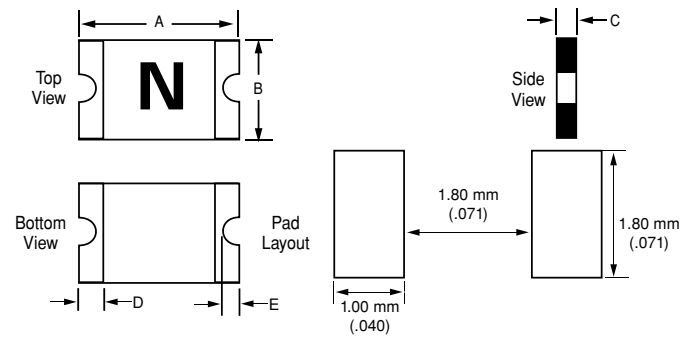

Part Number	A				B				C				D		E			
	Inches		mm		Inches		mm		Inches		mm		Inches	mm	Inches		mm	
	Min.	Max.	Min.	Max.	Min.	Max.	Min.	Max.	Min.	Max.	Min.	Max.	Min.	Min.	Min.	Max.	Min.	Max.
1206L012	0.12	0.14	3	3.5	0.06	0.07	1.5	1.8	0.03	0.06	0.65	1.45	0.01	0.2	0.004	0.02	0.1	0.45
1206L016	0.12	0.14	3	3.5	0.06	0.07	1.5	1.8	0.03	0.06	0.65	1.45	0.01	0.2	0.004	0.02	0.1	0.45
1206L020-C	0.12	0.14	3	3.5	0.06	0.07	1.5	1.8	0.02	0.04	0.5	1	0.01	0.2	0.004	0.02	0.1	0.45
1206L025-C	0.12	0.14	3	3.5	0.06	0.07	1.5	1.8	0.02	0.04	0.5	1	0.01	0.2	0.004	0.02	0.1	0.45
1206L035-C	0.12	0.14	3	3.5	0.06	0.07	1.5	1.8	0.02	0.03	0.45	0.75	0.01	0.2	0.004	0.02	0.1	0.45
1206L035/16	0.12	0.14	3	3.5	0.06	0.07	1.5	1.8	0.02	0.03	0.45	0.75	0.01	0.2	0.004	0.02	0.1	0.45
1206L050-C	0.12	0.14	3	3.5	0.06	0.07	1.5	1.8	0.02	0.03	0.45	0.75	0.01	0.2	0.004	0.02	0.1	0.45
1206L050/15	0.12	0.14	3	3.5	0.06	0.07	1.5	1.8	0.02	0.03	0.45	0.75	0.01	0.2	0.004	0.02	0.1	0.45
1206L075-C	0.12	0.14	3	3.5	0.06	0.07	1.5	1.8	0.02	0.05	0.45	1.25	0.01	0.2	0.004	0.02	0.1	0.45
1206L100	0.12	0.13	3	3.4	0.06	0.07	1.5	1.8	0.03	0.04	0.75	1	0.01	0.2	0.004	0.02	0.1	0.45
1206L110-C	0.12	0.13	3	3.4	0.06	0.07	1.5	1.8	0.03	0.04	0.75	1	0.01	0.2	0.004	0.02	0.1	0.45
1206L150-C	0.12	0.13	3	3.4	0.06	0.07	1.5	1.8	0.03	0.06	0.85	1.4	0.01	0.2	0.004	0.02	0.1	0.45

Part Numbering System

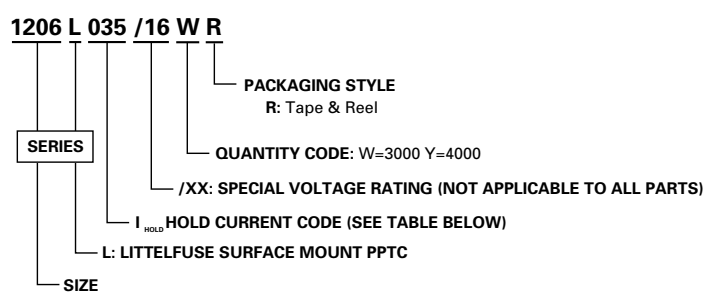

Packaging

I_{hold} (A)	I_{hold} Code	Packaging Option	Quantity	Quantity & Packaging Codes
0.125	012	Tape and Reel	3000	WR
0.16	016	Tape and Reel	3000	WR
0.20	020	Tape and Reel	4000	YR
0.25	025	Tape and Reel	4000	YR
0.35	035	Tape and Reel	4000	YR
0.50	050	Tape and Reel	4000	YR
0.75	075	Tape and Reel	3000	WR
1.00	100	Tape and Reel	3000	WR
1.10	110	Tape and Reel	3000	WR
1.50	150	Tape and Reel	2000	PR



Description

The 1210L series device provides surface mount overcurrent protection for applications where space is at a premium and resettable protection is desired.

Features

- RoHS compliant and lead-free
- Fast response to fault currents
- Compact design saves board space
- Low resistance
- Low-profile
- Compatible with high temperature solders

Applications

- USB peripherals
- Disk drives
- CD-ROMs
- PC motherboards - plug and play protection
- Mobile phones - battery and port protection
- PDAs / digital cameras
- Game console port protection

Agency Approvals

AGENCY	AGENCY FILE NUMBER
	E183209
	R50082521

Electrical Characteristics

Part Number	Marking	I _{hold} (A)	I _{trip} (A)	V _{max} (Vdc)	I _{max} (A)	P _d max. (W)	Maximum Time To Trip		Resistance			Agency Approvals	
							Current (A)	Time (Sec.)	R _{min} (Ω)	R _{typ} (Ω)	R _{1max} (Ω)		
1210L005	A	0.05	0.15	30	10	0.60	0.25	1.50	3.600	25.00	50.00	X	X
1210L010	B	0.10	0.30	30	10	0.60	0.50	1.50	1.600	7.000	15.00	X	X
1210L020	C	0.20	0.40	30	10	0.60	8.00	0.02	0.800	2.900	5.000	X	X
1210L035	E	0.35	0.70	6	100	0.60	8.00	0.20	0.320	0.810	1.300	X	X
1210L050	F	0.50	1.00	13.2	100	0.60	8.00	0.10	0.250	0.550	0.900	X	X
1210L075	G	0.75	1.50	6	100	0.60	8.00	0.10	0.130	0.290	0.400	X	X
1210L110	H	1.10	2.20	6	100	0.60	8.00	0.30	0.060	0.140	0.210	X	X
1210L150	K	1.50	3.00	6	100	0.80	8.00	0.50	0.040	0.070	0.110	X	X

I_{hold} = Hold current: maximum current device will pass without tripping in 20°C still air.

I_{trip} = Trip current: minimum current at which the device will trip in 20°C still air.

V_{max} = Maximum voltage device can withstand without damage at rated current (I_{max})

I_{max} = Maximum fault current device can withstand without damage at rated voltage (V_{max})

P_d = Power dissipated from device when in the tripped state at 20°C still air.

R_{min} = Minimum resistance of device in initial (un-soldered) state.

R_{typ} = Typical resistance of device in initial (un-soldered) state.

R_{1max} = Maximum resistance of device at 20°C measured one hour after tripping or reflow soldering of 260°C for 20 sec.

Caution: Operation beyond the specified rating may result in damage and possible arcing and flame.

Temperature Derating

Part Number	Ambient Operation Temperature								
	-40°C	-20°C	0°C	23°C	40°C	50°C	60°C	70°C	85°C
1210L005	0.08	0.07	0.06	0.05	0.04	0.04	0.03	0.03	0.02
1210L010	0.16	0.14	0.12	0.10	0.08	0.07	0.06	0.05	0.03
1210L020	0.29	0.26	0.22	0.20	0.16	0.14	0.13	0.11	0.08
1210L035	0.47	0.45	0.40	0.35	0.33	0.28	0.24	0.21	0.18
1210L050	0.76	0.67	0.58	0.50	0.43	0.40	0.36	0.32	0.28
1210L075	1.00	0.97	0.86	0.75	0.64	0.59	0.54	0.48	0.40
1210L110	1.69	1.48	1.29	1.10	0.88	0.76	0.65	0.57	0.43
1210L150	2.13	1.92	1.71	1.50	1.26	1.14	1.01	0.89	0.71

Average Time Current Curves

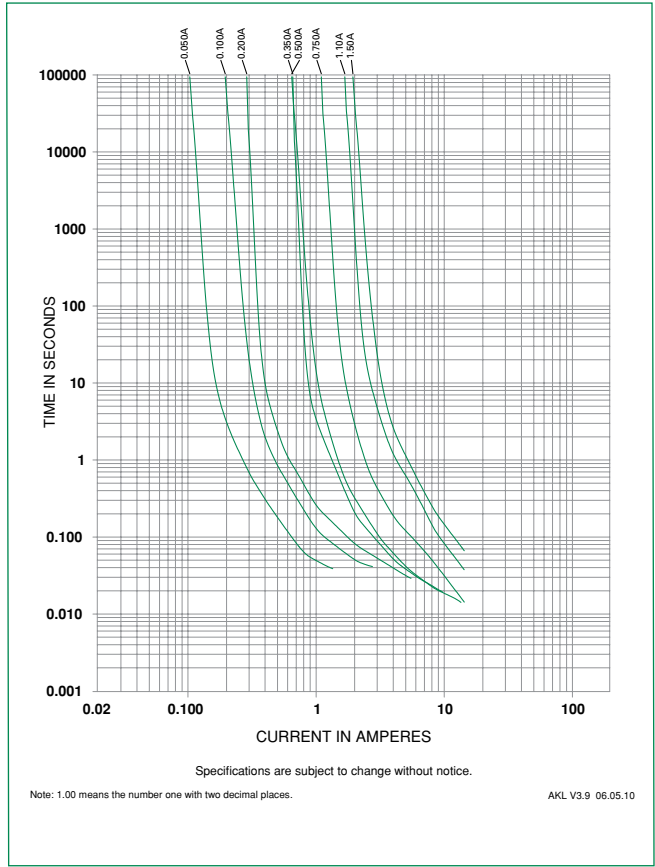

Temperature Derating Curve

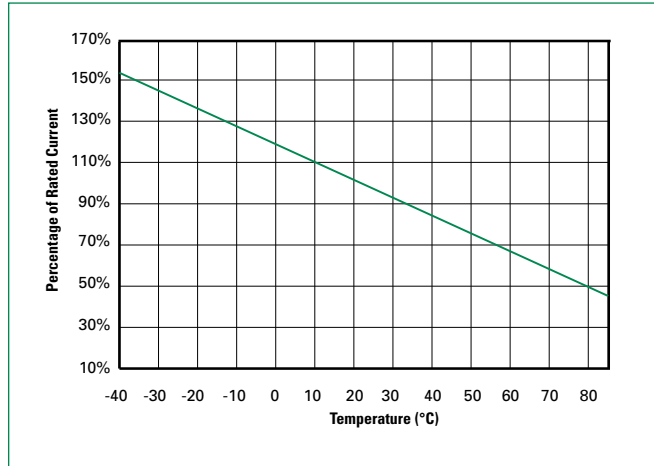

The average time current curves and temperature derating curve performance is affected by a number of variables, and these curves provided as guidance only. Customer must verify the performance in their application.

Soldering Parameters

Condition	Reflow
Peak Temp/ Duration Time	260°C / 10 Sec
Time above liquids (TAL) 220°C	60 Sec ~ 100 Sec
Preheat 120°C~ 180°C	50 Sec ~ 150 Sec
Storage Condition	0°C~35°C, ≤70%RH

- Recommended reflow methods: IR, vapor phase oven, hot air oven, N₂ environment for lead-free
- Devices are not designed to be wave soldered to the bottom side of the board.
- Recommended maximum paste thickness is 0.25mm (0.010 inch)
- Devices can be cleaned using standard industry methods and solvents.

Note: If reflow temperatures exceed the recommended profile, devices may not meet the performance requirements.

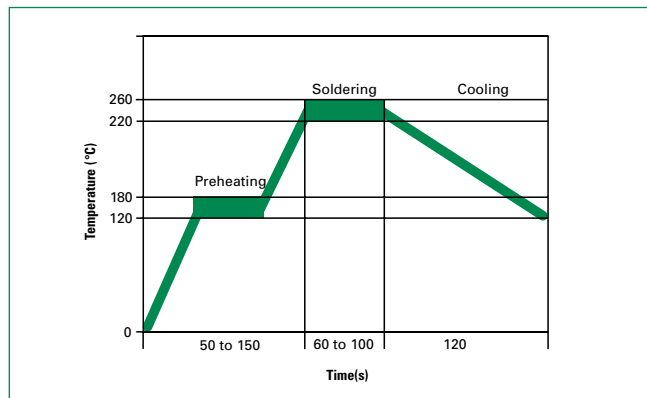

Physical Specifications

Terminal Material	Solder-Plated Copper (Solder Material: Matte Tin (Sn))
Lead Solderability	Meets EIA Specification RS186-9E, ANSI/J-STD-002 Category 3.

Environmental Specifications

Operating/Storage Temperature	-40°C to +85°C
Maximum Device Surface Temperature in Tripped State	125°C
Passive Aging	+85°C, 1000 hours ±5% typical resistance change
Humidity Aging	+85°C, 85% R.H. 1000 hours ±5% typical resistance change
Thermal Shock	MIL-STD-202 Method 107G +85°C/-40°C 20 times -30% typical resistance change
Solvent Resistance	MIL-STD-202, Method 215 No change
Vibration	MIL-STD-883C, Method 2007.1, Condition A No change

Dimensions

MARKING CODE VARIES WITH AMPERAGE RATING (SEE CHART)
SHOWN IS 1.5AMP RATING

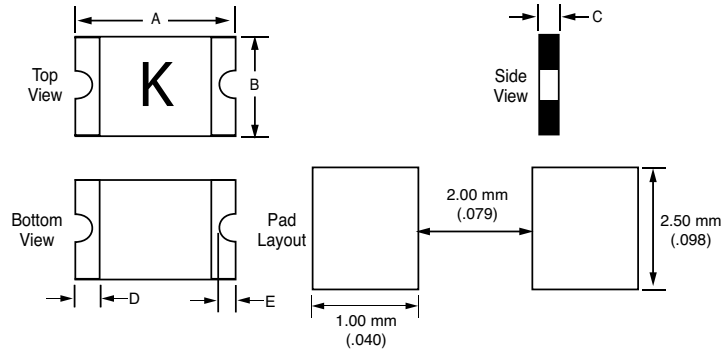

Part Number	A		B		C		D		E									
	Inches	mm	Inches	mm	Inches	mm	Inches	mm	Inches	mm								
	Min.	Max.	Min.	Max.	Min.	Max.	Min.	Max.	Min.	Max.								
1210L005	0.12	0.14	3.00	3.43	0.09	0.11	2.35	2.80	0.03	0.05	0.75	1.25	0.01	0.25	0.008	0.02	0.20	0.50
1210L010	0.12	0.14	3.00	3.43	0.09	0.11	2.35	2.80	0.03	0.05	0.75	1.25	0.01	0.25	0.008	0.02	0.20	0.50
1210L020	0.12	0.14	3.00	3.43	0.09	0.11	2.35	2.80	0.02	0.04	0.60	1.00	0.01	0.25	0.008	0.02	0.20	0.50
1210L035	0.12	0.14	3.00	3.43	0.09	0.11	2.35	2.80	0.02	0.03	0.50	0.85	0.01	0.25	0.008	0.02	0.20	0.50
1210L050	0.12	0.14	3.00	3.43	0.09	0.11	2.35	2.80	0.02	0.03	0.50	0.85	0.01	0.25	0.008	0.02	0.20	0.50
1210L075	0.12	0.14	3.00	3.43	0.09	0.11	2.35	2.80	0.02	0.03	0.50	0.85	0.01	0.25	0.008	0.02	0.20	0.50
1210L110	0.12	0.14	3.00	3.43	0.09	0.11	2.35	2.80	0.04	0.05	0.90	1.30	0.01	0.25	0.008	0.02	0.20	0.50
1210L150	0.12	0.14	3.00	3.43	0.09	0.11	2.35	2.80	0.03	0.07	0.80	1.80	0.01	0.25	0.008	0.02	0.20	0.50

Part Numbering System

1210 L 110 W R

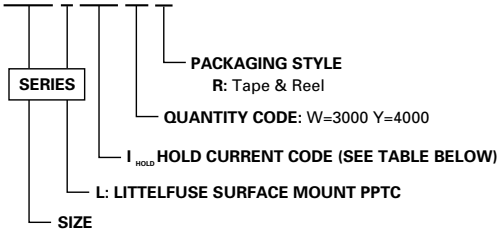

Packaging

I _{hold} (A)	I _{hold} Code	Packaging Option	Quantity	Quantity & Packaging Codes
0.05	005	Tape and Reel	3000	WR
0.10	010	Tape and Reel	3000	WR
0.20	020	Tape and Reel	3000	WR
0.35	035	Tape and Reel	4000	YR
0.50	050	Tape and Reel	4000	YR
0.75	075	Tape and Reel	4000	YR
1.10	110	Tape and Reel	3000	WR
1.50	150	Tape and Reel	2000	PR

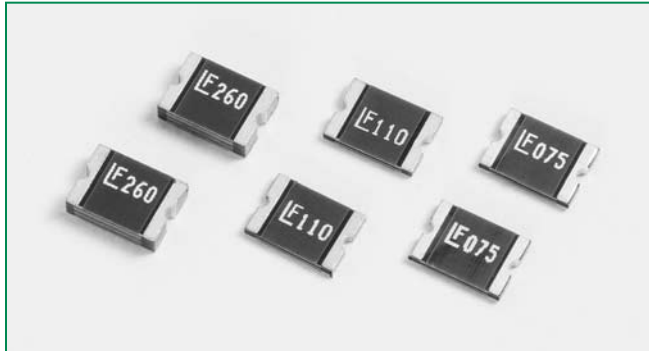

Description

The 1812L series device provides surface mount overcurrent protection for applications where resettable protection is desired.

Features

- RoHS compliant and lead-free
- Fast response to fault currents
- Compact design saves board space
- Low resistance
- Low-profile
- Compatible with high temperature solders

Agency Approvals

AGENCY	AGENCY FILE NUMBER
	E183209
	R50082521



Applications

- Plug and play protection for motherboards and peripherals
- USB peripherals
- PCI cards
- Game console port protection

Electrical Characteristics

Part Number	Marking	I _{hold} (A)	I _{trip} (A)	V _{max} (Vdc)	I _{max} (A)	P _{d max.} (W)	Maximum Time To Trip		Resistance			Agency Approvals	
							Current (A)	Time (Sec.)	R _{min} (Ω)	R _{typ} (Ω)	R _{1max} (Ω)		
1812L010	LF010	0.10	0.30	30	100	0.8	0.50	1.50	1.600	7.000	15.000	X	X
1812L014	LF014	0.14	0.34	60	10	0.8	1.50	0.15	1.500	4.000	6.000	X	X
1812L020	LF020	0.20	0.40	30	100	0.8	8.00	0.02	0.800	2.900	5.000	X	X
1812L050-C	LF050	0.50	1.00	15	100	0.8	8.00	0.15	0.150	0.600	1.000	X	X
1812L075-C	LF075	0.75	1.50	13.2	100	0.8	8.00	0.20	0.100	0.260	0.450	X	X
1812L075/24	LF075-24	0.75	1.50	24	100	0.8	8.00	0.20	0.110	0.200	0.290	X	X
1812L075/33	LF075-33	0.75	1.50	33	20	0.8	8.00	0.20	0.110	0.260	0.400	X	X
1812L110-C	LF110	1.10	2.20	6	100	0.8	8.00	0.30	0.040	0.120	0.210	X	X
1812L110/16	LF110-16	1.10	1.95	16	100	0.8	8.00	0.50	0.060	0.120	0.180	X	X
1812L110/33	LF110-33	1.10	1.95	33	20	0.8	8.00	0.50	0.060	0.120	0.200	X	X
1812L125-C	LF125	1.25	2.50	15	100	0.8	8.00	0.40	0.050	0.160	0.250	X	X
1812L125/6	LF125-6	1.25	2.50	6	100	0.8	8.00	0.40	0.050	0.090	0.140	X	X
1812L150-C	LF150	1.50	3.00	8	100	0.8	8.00	0.30	0.040	0.070	0.110	X	X
1812L150/12	LF150-12	1.50	3.00	12	100	0.8	8.00	0.50	0.040	0.070	0.110	X	X
1812L150/24	LF150-24	1.50	3.00	24	20	0.8	8.00	1.50	0.040	0.070	0.120	X	X
1812L160-C	LF160	1.60	2.80	8	100	0.8	8.00	1.00	0.030	0.066	0.100	X	X

Electrical Characteristics (continued)

Part Number	Marking	I _{hold} (A)	I _{trip} (A)	V _{max} (Vdc)	I _{max} (A)	P _d max. (W)	Maximum Time To Trip		Resistance			Agency Approvals	
							Current (A)	Time (Sec.)	R _{min} (Ω)	R _{typ} (Ω)	R _{1max} (Ω)	 US	
1812L160/12	LF160-12	1.60	2.80	12	100	0.8	8.00	1.00	0.030	0.066	0.100	X	X
1812L200-C	LF200	2.00	3.50	8	100	0.8	8.00	2.00	0.020	0.040	0.060	X	X
1812L260-C	LF260	2.60	5.00	6	100	0.8	8.00	2.50	0.015	0.030	0.047	X	X

I_{hold} = Hold current: maximum current device will pass without tripping in 20°C still air.

I_{trip} = Trip current: minimum current at which the device will trip in 20°C still air.

V_{max} = Maximum voltage device can withstand without damage at rated current (I_{max})

I_{max} = Maximum fault current device can withstand without damage at rated voltage (V_{max})

P_d = Power dissipated from device when in the tripped state at 20°C still air.

R_{min} = Minimum resistance of device in initial (un-soldered) state.

R_{typ} = Typical resistance of device in initial (un-soldered) state.

R_{1max} = Maximum resistance of device at 20°C measured one hour after tripping or reflow soldering of 260°C for 20 sec.

Caution: Operation beyond the specified rating may result in damage and possible arcing and flame.

Temperature Rerating

Part Number	Ambient Operation Temperature								
	-40°C	-20°C	0°C	23°C	40°C	50°C	60°C	70°C	85°C
	Hold Current (A)								
1812L010	0.16	0.14	0.12	0.10	0.08	0.07	0.06	0.05	0.03
1812L014	0.23	0.19	0.17	0.14	0.12	0.10	0.09	0.08	0.06
1812L020	0.29	0.26	0.23	0.20	0.17	0.15	0.14	0.12	0.10
1812L050-C	0.77	0.68	0.59	0.50	0.44	0.40	0.37	0.33	0.29
1812L075-C	1.15	1.01	0.88	0.75	0.65	0.60	0.55	0.49	0.43
1812L075/24	1.06	0.95	0.84	0.75	0.60	0.55	0.50	0.45	0.37
1812L075/33	1.10	1.00	0.88	0.75	0.66	0.60	0.56	0.47	0.36
1812L110-C	1.59	1.43	1.26	1.10	0.95	0.87	0.80	0.71	0.60
1812L110/16	1.58	1.43	1.27	1.10	0.95	0.85	0.77	0.71	0.58
1812L110/33	1.55	1.40	1.25	1.10	0.93	0.83	.073	.063	.050
1812L125-C	2.00	1.75	1.52	1.25	1.00	0.95	0.90	0.75	0.53
1812L125/6	2.00	1.75	1.52	1.25	1.00	0.95	0.90	0.75	0.53
1812L150-C	2.06	1.93	1.79	1.50	1.28	1.10	1.02	0.80	0.68
1812L150/12	2.04	1.88	1.68	1.50	1.25	1.10	1.00	0.80	0.60
1812L150/24	2.05	1.87	1.67	1.50	1.25	1.08	0.95	0.77	0.60
1812L160-C	2.20	2.06	1.91	1.60	1.36	1.17	1.09	0.85	0.72
1812L160/12	2.18	2.01	1.79	1.60	1.34	1.16	1.07	0.83	0.60
1812L200-C	3.08	2.71	2.35	2.00	1.80	1.60	1.50	1.07	0.80
1812L260-C	4.00	3.52	3.06	2.60	2.34	2.08	1.95	1.39	1.04

Average Time Current Curves

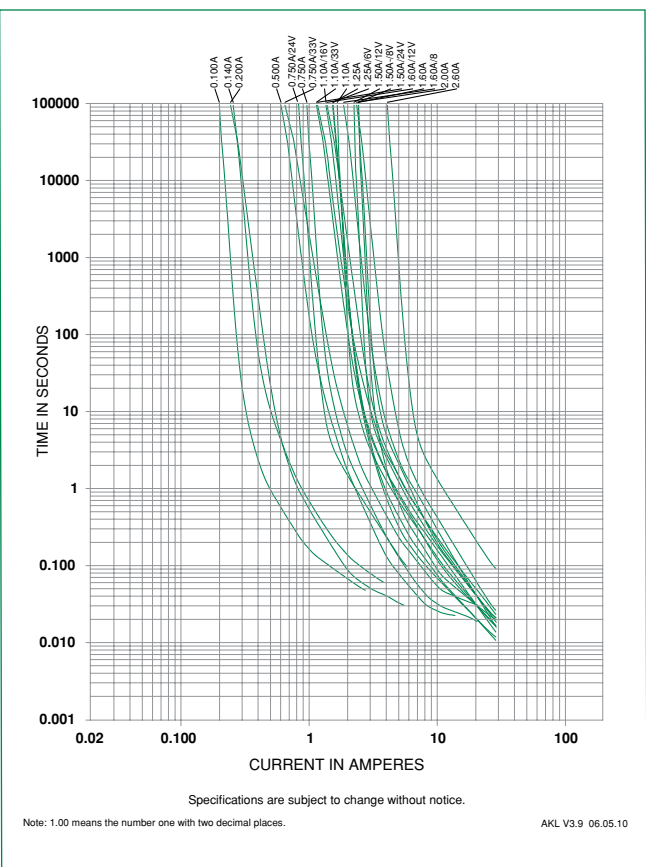

Temperature Rerating Curve

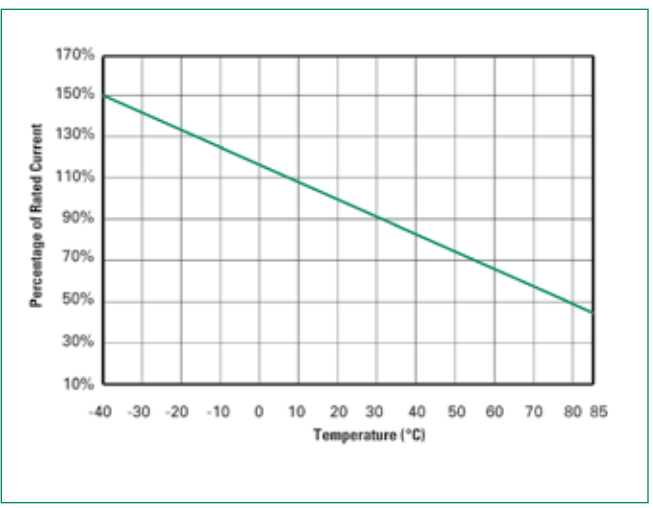

The average time current curves and temperature rerating curve performance is affected by a number of variables, and these curves provided as guidance only. Customer must verify the performance in their application.

Soldering Parameters

Condition	Reflow
Peak Temp/ Duration Time	260°C / 10 Sec
Time above liquids (TAL) 220°C	60 Sec ~ 100 Sec
Preheat 120°C~ 180°C	50 Sec ~ 150 Sec
Storage Condition	0°C~35°C, ≤70%RH

- Recommended reflow methods: IR, vapor phase oven, hot air oven, N₂ environment for lead-free
- Devices are not designed to be wave soldered to the bottom side of the board.
- Recommended maximum paste thickness is 0.25mm (0.010 inch)
- Devices can be cleaned using standard industry methods and solvents.

Note: If reflow temperatures exceed the recommended profile, devices may not meet the performance requirements.

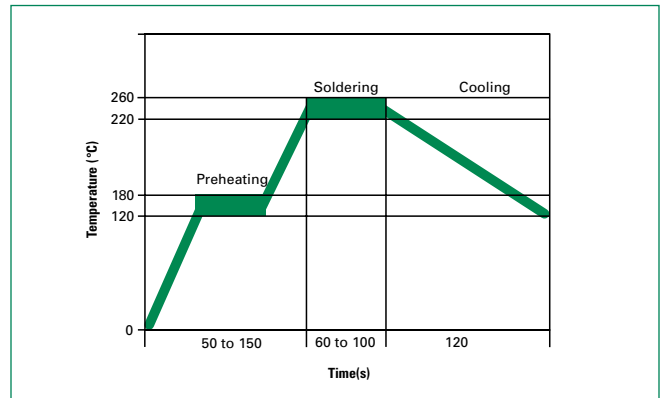
Physical Specifications

Terminal Material	Solder-Plated Copper (Solder Material: Matte Tin (Sn))
Lead Solderability	Meets EIA Specification RS186-9E, ANSI/J-STD-002 Category 3.

Environmental Specifications

Operating/Storage Temperature	-40°C to +85°C
Maximum Device Surface Temperature in Tripped State	125°C
Passive Aging	+85°C, 1000 hours ±5% typical resistance change
Humidity Aging	+85°C, 85% R.H. 1000 hours ±5% typical resistance change
Thermal Shock	MIL-STD-202 Method 107G +85°C/-40°C 20 times -30% typical resistance change
Solvent Resistance	MIL-STD-202, Method 215 No change
Vibration	MIL-STD-883C, Method 2007.1, Condition A No change

Dimensions

MARKING CODE VARIES
WITH AMPERAGE AND VOLTAGE RATING
(SEE CHART)
SHOWN ARE:
- 1.1A/6V RATING (LEFT)
- 1.1A/33V RATING (RIGHT)

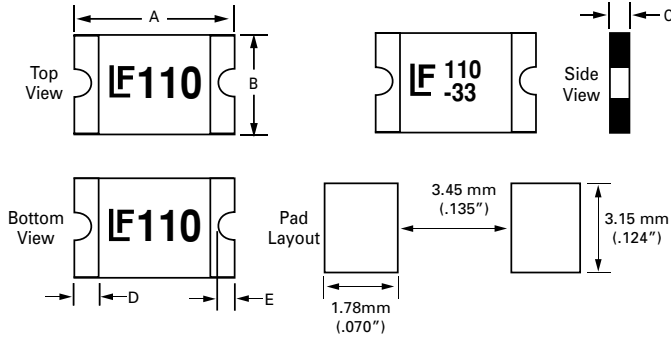

Part Number	A				B				C				D		E			
	Inches		mm		Inches		mm		Inches		mm		Inches	mm	Inches		mm	
	Min.	Max.	Min.	Max.	Min.	Max.	Min.	Max.	Min.	Max.	Min.	Max.	Min.	Min.	Min.	Max.	Min.	Max.
1812L010	0.17	0.19	4.37	4.73	0.12	0.13	3.07	3.41	0.03	0.05	0.75	1.25	0.01	0.30	0.01	0.03	0.25	0.65
1812L014	0.17	0.19	4.37	4.73	0.12	0.13	3.07	3.41	0.03	0.08	0.75	1.95	0.01	0.30	0.01	0.03	0.25	0.65
1812L020	0.17	0.19	4.37	4.73	0.12	0.13	3.07	3.41	0.02	0.04	0.55	1	0.01	0.30	0.01	0.03	0.25	0.65
1812L050-C	0.17	0.19	4.37	4.73	0.12	0.13	3.07	3.41	0.02	0.03	0.5	0.75	0.01	0.30	0.01	0.02	0.25	0.5
1812L075-C	0.17	0.19	4.37	4.73	0.12	0.13	3.07	3.41	0.02	0.03	0.5	0.75	0.01	0.30	0.01	0.02	0.25	0.5
1812L075/24	0.17	0.19	4.37	4.73	0.12	0.13	3.07	3.41	0.03	0.06	0.75	1.55	0.01	0.30	0.01	0.03	0.25	0.65
1812L075/33	0.17	0.19	4.37	4.73	0.12	0.13	3.07	3.41	0.03	0.06	0.75	1.55	0.01	0.30	0.01	0.03	0.25	0.65
1812L110-C	0.17	0.19	4.37	4.73	0.12	0.13	3.07	3.41	0.02	0.03	0.5	0.71	0.01	0.30	0.01	0.02	0.25	0.5
1812L110/16	0.17	0.19	4.37	4.73	0.12	0.13	3.07	3.41	0.03	0.05	0.75	1.25	0.01	0.30	0.01	0.03	0.25	0.65
1812L110/33	0.17	0.19	4.37	4.73	0.12	0.13	3.07	3.41	0.05	0.08	1.2	2	0.01	0.30	0.01	0.03	0.25	0.65
1812L125-C	0.17	0.19	4.37	4.73	0.12	0.13	3.07	3.41	0.03	0.05	0.75	1.25	0.01	0.30	0.01	0.02	0.25	0.5
1812L125/6	0.17	0.19	4.37	4.73	0.12	0.13	3.07	3.41	0.02	0.03	0.45	0.75	0.01	0.30	0.01	0.03	0.25	0.65
1812L150-C	0.17	0.19	4.37	4.73	0.12	0.13	3.07	3.41	0.02	0.03	0.4	0.71	0.01	0.30	0.01	0.03	0.25	0.65
1812L150/12	0.17	0.19	4.37	4.73	0.12	0.13	3.07	3.41	0.03	0.05	0.75	1.25	0.01	0.30	0.01	0.03	0.25	0.65
1812P150/24	0.17	0.19	4.37	4.73	0.12	0.13	3.07	3.41	0.03	0.07	0.8	1.8	0.01	0.30	0.01	0.03	0.25	0.65
1812L160-C	0.17	0.19	4.37	4.73	0.12	0.13	3.07	3.41	0.02	0.03	0.4	0.75	0.01	0.30	0.01	0.03	0.25	0.65
1812L160/12	0.17	0.19	4.37	4.73	0.12	0.13	3.07	3.41	0.03	0.05	0.75	1.25	0.01	0.30	0.01	0.03	0.25	0.65
1812L200-C	0.17	0.19	4.37	4.73	0.12	0.13	3.07	3.41	0.03	0.05	0.81	1.2	0.01	0.30	0.01	0.02	0.25	0.5
1812L260-C	0.17	0.19	4.37	4.73	0.12	0.13	3.07	3.41	0.03	0.05	0.8	1.34	0.01	0.30	0.01	0.02	0.25	0.5

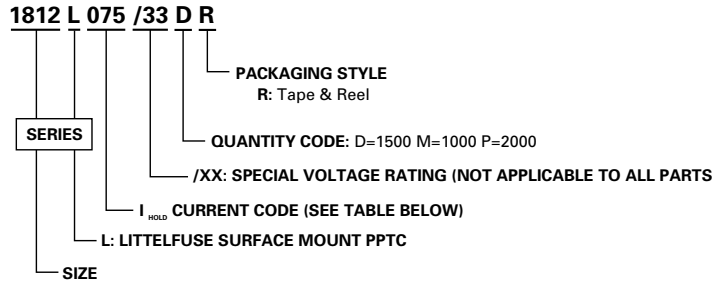
Part Numbering System

Packaging

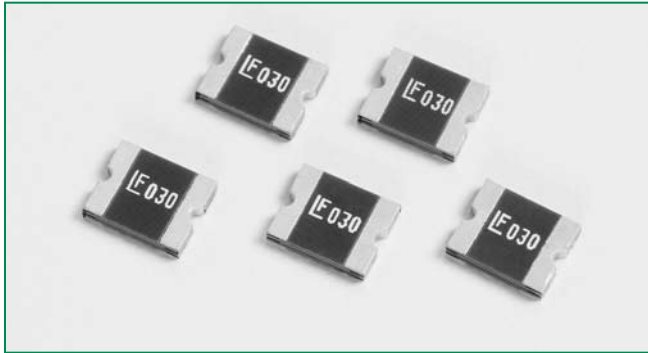
I _{hold} (A)	I _{hold} Code	Voltage Option	Packaging Option	Quantity	Quantity & Packaging Codes
0.10	010		Tape and Reel	1500	DR
0.14	014		Tape and Reel	1500	DR
0.20	020		Tape and Reel	2000	PR
0.50	050		Tape and Reel	2000	PR
0.75	075		Tape and Reel	2000	PR
		/24	Tape and Reel	1500	DR
		/33	Tape and Reel	1500	DR
1.10	110		Tape and Reel	2000	PR
		/16	Tape and Reel	1500	DR
		/33	Tape and Reel	1000	MR
1.25	125		Tape and Reel	1500	DR
		/6	Tape and Reel	2000	PR
1.50	150		Tape and Reel	2000	ZR
		/12	Tape and Reel	1500	DR
		/24	Tape and Reel	1000	MR
1.60	160		Tape and Reel	2000	PR
		/12	Tape and Reel	1500	DR
2.00	200		Tape and Reel	1500	DR
2.60	260		Tape and Reel	1000	ZR



Description

The 2016L series device provides surface mount overcurrent protection for low voltage ($\leq 60V$) applications where resettable protection is desired.

Features

- RoHS compliant and lead-free
- High voltage
- Fast response to fault currents
- Low-profile

Applications

- IEE1394 port protection
- Low voltage telecom equipment protection
- Powered ethernet port protection (IEEE 802.3 af)
- Automotive electronic control module protection

Agency Approvals

AGENCY	AGENCY FILE NUMBER
	E183209
	R50082521

Electrical Characteristics

Part Number	Marking	I_{hold} (A)	I_{trip} (A)	V_{max} (Vdc)	I_{max} (A)	P_d max. (W)	Maximum Time To Trip		Resistance			Agency Approvals	
							Current (A)	Time (Sec.)	R_{min} (Ω)	R_{typ} (Ω)	R_{1max} (Ω)		
2016L030	LF030	0.30	0.60	60	20	1.40	1.50	3.00	0.500	1.400	2.300	X	X
2016L050	LF050	0.55	1.10	60	20	1.40	2.50	5.00	0.200	0.700	1.000	X	X
2016L100	LF100	1.10	2.20	15	40	1.40	8.00	0.50	0.100	0.250	0.400	X	X
2016L100/33	LF100-33	1.10	2.20	33	40	1.40	8.00	0.50	0.100	0.250	0.400	X	X
2016L150	LF150	1.50	3.00	15	40	1.40	8.00	1.00	0.070	0.130	0.180	X	X
2016L200	LF200	2.00	4.20	6	40	1.40	8.00	3.00	0.048	0.070	0.100	X	X

I_{hold} = Hold current: maximum current device will pass without tripping in 20°C still air.
 I_{trip} = Trip current: minimum current at which the device will trip in 20°C still air.
 V_{max} = Maximum voltage device can withstand without damage at rated current (I_{max})
 I_{max} = Maximum fault current device can withstand without damage at rated voltage (V_{max})
 P_d = Power dissipated from device when in the tripped state at 20°C still air.
 R_{min} = Minimum resistance of device in initial (un-soldered) state.

R_{typ} = Typical resistance of device in initial (un-soldered) state.
 R_{1max} = Maximum resistance of device at 20°C measured one hour after tripping or reflow soldering of 260°C for 20 sec.

Caution: Operation beyond the specified rating may result in damage and possible arcing and flame.

Temperature Derating

Part Number	Ambient Operation Temperature								
	-40°C	-20°C	0°C	23°C	40°C	50°C	60°C	70°C	85°C
2016L030	0.45	0.40	0.35	0.30	0.25	0.23	0.20	0.18	0.14
2016L050	0.93	0.80	0.65	0.50	0.38	0.32	0.25	0.19	0.09
2016L100	1.66	1.47	1.29	1.10	0.91	0.83	0.73	0.64	0.50
2016L100/33	1.66	1.47	1.29	1.10	0.91	0.83	0.73	0.64	0.50
2016L150	2.26	2.00	1.76	1.50	1.24	1.13	1.00	0.87	0.68
2016L200	2.80	2.50	2.19	2.00	1.84	1.74	1.50	1.34	1.14

Average Time Current Curves

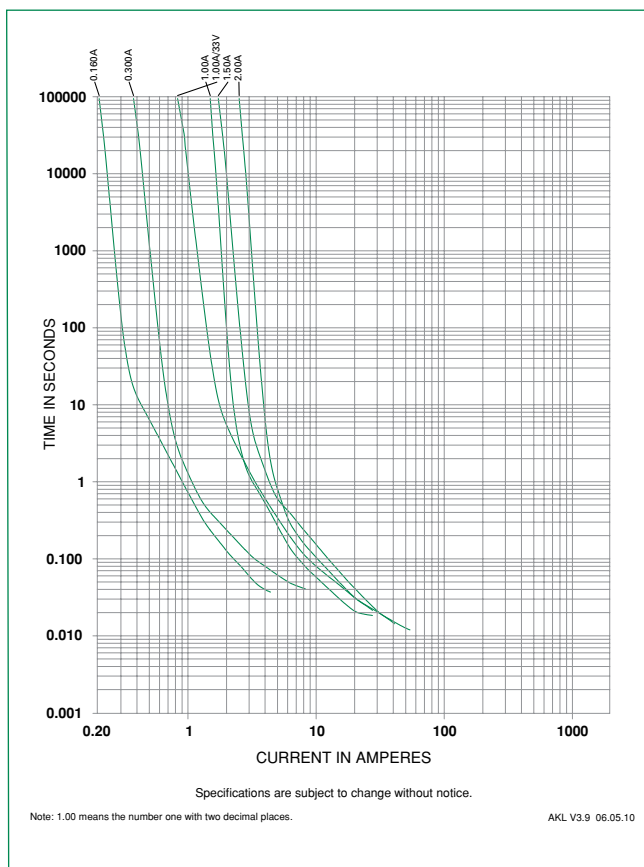

The average time current curves and temperature derating curve performance is affected by a number of variables, and these curves provided as guidance only. Customer must verify the performance in their application.

Temperature Derating Curve

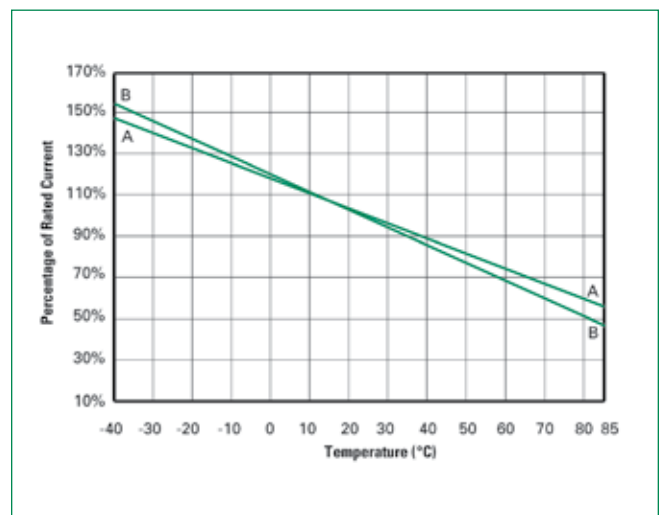

A: 2016L050
 2016L100
 2016L200

B: 2016L030
 2016L100/33
 2016L150

Soldering Parameters

Condition	Reflow
Peak Temp/ Duration Time	260°C / 10 Sec
Time above liquids (TAL) 220°C	60 Sec ~ 100 Sec
Preheat 120°C~ 180°C	50 Sec ~ 150 Sec
Storage Condition	0°C~35°C, ≤70%RH

- Recommended reflow methods: IR, vapor phase oven, hot air oven, N₂ environment for lead-free
- Devices are not designed to be wave soldered to the bottom side of the board.
- Recommended maximum paste thickness is 0.25mm (0.010 inch)
- Devices can be cleaned using standard industry methods and solvents.

Note: If reflow temperatures exceed the recommended profile, devices may not meet the performance requirements.

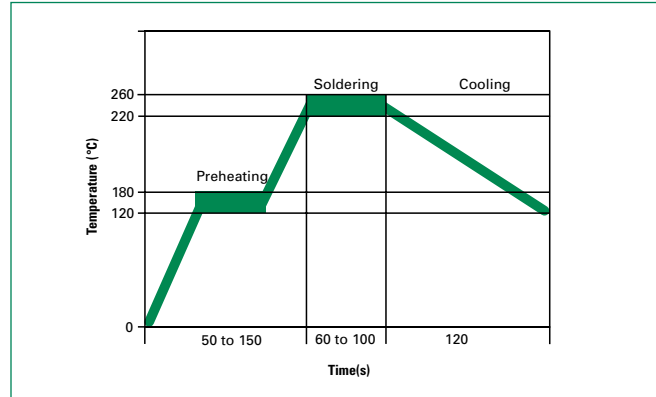

Physical Specifications

Terminal Material	Solder-Plated Copper (Solder Material: Matte Tin(Sn))
Lead Solderability	Meets EIA Specification RS186-9E, ANSI/J-STD-002 Category 3.

Environmental Specifications

Operating/Storage Temperature	-40°C to +85°C
Maximum Device Surface Temperature in Tripped State	125°C
Passive Aging	+85°C, 1000 hours ±5% typical resistance change
Humidity Aging	+85°C, 85% R.H. 1000 hours ±5% typical resistance change
Thermal Shock	MIL-STD-202 Method 107G +85°C/-40°C 20 times -30% typical resistance change
Solvent Resistance	MIL-STD-202, Method 215 No change
Vibration	MIL-STD-883C, Method 2007.1, Condition A No change

Dimensions (mm)

MARKING CODE VARIES WITH AMPERAGE AND VOLTAGE RATING (SEE CHART) SHOWN ARE:
 - 1.0A/15V RATING (LEFT)
 - 1.0A/33V RATING (RIGHT)

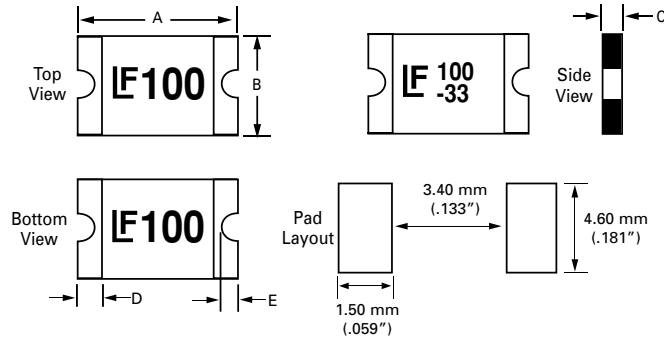

Part Number	A				B				C				D		E			
	Inches		mm		Inches		mm		Inches		mm		Inches	mm	Inches	mm	Inches	mm
	Min.	Max.	Min.	Max.	Min.	Max.	Min.	Max.	Min.	Max.	Min.	Max.	Min.	Min.	Min.	Max.	Min.	Max.
2016L030	0.19	0.21	4.72	5.44	0.15	0.17	3.7	4.43	0.03	0.05	0.75	1.25	0.01	0.03	0.01	0.03	0.25	0.65
2016L050	0.19	0.21	4.72	5.44	0.15	0.17	3.7	4.43	0.05	0.08	1.2	2	0.01	0.03	0.01	0.03	0.25	0.65
2016L100	0.19	0.21	4.72	5.44	0.15	0.17	3.7	4.43	0.02	0.03	0.5	0.75	0.01	0.03	0.01	0.03	0.25	0.65
2016L100/33	0.19	0.21	4.72	5.44	0.15	0.17	3.7	4.43	0.03	0.05	0.75	1.25	0.01	0.03	0.01	0.03	0.25	0.65
2016L150	0.19	0.21	4.72	5.44	0.15	0.17	3.7	4.43	0.03	0.06	0.75	1.55	0.01	0.03	0.01	0.03	0.25	0.65
2016L200	0.19	0.21	4.72	5.44	0.15	0.17	3.7	4.43	0.02	0.03	0.5	0.75	0.01	0.03	0.01	0.03	0.25	0.65

Part Numbering System

2016 L 100 /33 D R

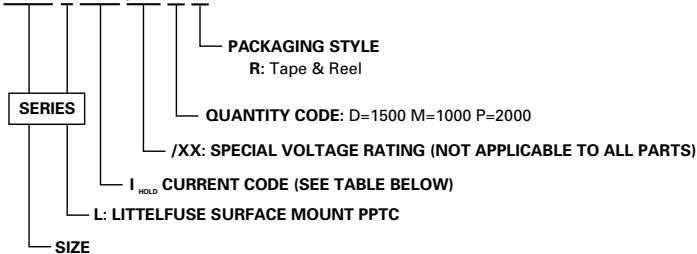

Packaging

I _{hold} (A)	I _{hold} Code	Voltage Option	Packaging Option	Quantity	Quantity & Packaging Codes
0.30	030		Tape and Reel	1500	DR
0.55	050		Tape and Reel	1000	MR
1.10	100		Tape and Reel	2000	PR
		/33	Tape and Reel	1500	DR
1.50	150		Tape and Reel	1500	DR
2.00	200		Tape and Reel	2000	PR

RoHS **2920L Series**

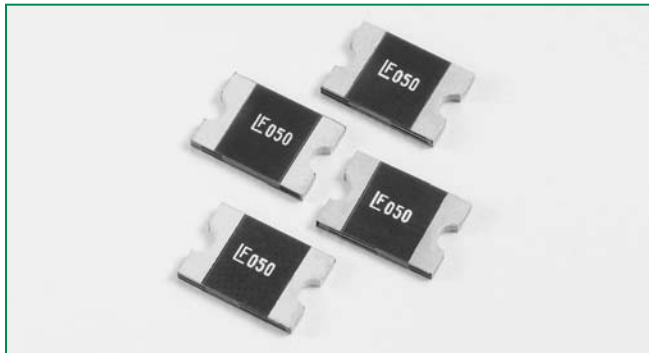

Description

The 2920L series device provides surface mount overcurrent protection for medium voltage ($\leq 60V$) applications where resettable protection is desired.

Features

- RoHS compliant and lead-free
- High voltage
- Fast response to fault currents
- Low-profile

Applications

- IEE1394 port protection
- Low voltage telecom equipment protection
- Powered ethernet port protection (IEEE 802.3 af)
- Automotive electronic control module protection

Agency Approvals

AGENCY	AGENCY FILE NUMBER
	E183209
	R50082521

Electrical Characteristics

Part Number	Marking	I_{hold} (A)	I_{trip} (A)	V_{max} (Vdc)	I_{max} (A)	P_d max. (W)	Maximum Time To Trip		Resistance			Agency Approvals	
							Current (A)	Time (Sec.)	R_{min} (Ω)	R_{typ} (Ω)	R_{1max} (Ω)		
2920L030	LF030	0.30	0.60	60	10	1.50	1.50	3.00	1.200	3.000	4.800	X	X
2920L050	LF050	0.50	1.00	60	10	1.50	2.50	4.00	0.350	0.870	1.400	X	X
2920L075	LF075	0.75	1.50	30	40	1.50	8.00	0.30	0.350	0.670	1.000	X	X
2920L100	LF100	1.10	2.20	33	40	1.50	8.00	0.50	0.120	0.270	0.410	X	X
2920L125	LF125	1.25	2.50	15	40	1.50	8.00	2.00	0.070	0.160	0.250	X	X
2920L150	LF150	1.50	3.00	33	40	1.50	8.00	2.00	0.080	0.150	0.230	X	X
2920L185	LF185	1.85	3.70	33	40	1.50	8.00	2.50	0.065	0.110	0.150	X	X
2920L200	LF200	2.00	4.00	15	40	1.50	8.00	5.00	0.050	0.090	0.125	X	X
2920L200/24	LF200-24	2.00	4.00	24	40	1.50	8.00	5.00	0.050	0.090	0.125	X	X
2920L250	LF250	2.50	5.00	15	40	1.50	8.00	10.00	0.035	0.060	0.085	X	X
2920L260	LF260	2.60	5.00	6	40	1.50	8.00	10.00	0.025	0.050	0.075	X	X
2920L300	LF300	3.00	5.00	6	40	1.50	8.00	20.00	0.015	0.033	0.048	X	X
2920L300/15	LF300-15	3.00	5.00	15	40	1.50	8.00	20.00	0.015	0.033	0.048	X	X

I_{hold} = Hold current: maximum current device will pass without tripping in 20°C still air.
 I_{trip} = Trip current: minimum current at which the device will trip in 20°C still air.
 V_{max} = Maximum voltage device can withstand without damage at rated current (I_{max})
 I_{max} = Maximum fault current device can withstand without damage at rated voltage (V_{max})
 P_d = Power dissipated from device when in the tripped state at 20°C still air.
 R_{min} = Minimum resistance of device in initial (un-soldered) state.

R_{typ} = Typical resistance of device in initial (un-soldered) state.
 R_{1max} = Maximum resistance of device at 20°C measured one hour after tripping or reflow soldering of 260°C for 20 sec.

Caution: Operation beyond the specified rating may result in damage and possible arcing and flame.

Temperature Derating

Part Number	Ambient Operation Temperature								
	-40°C	-20°C	0°C	23°C	40°C	50°C	60°C	70°C	85°C
2920L030	0.45	0.40	0.35	0.30	0.25	0.23	0.20	0.17	0.14
2920L050	0.76	0.67	0.59	0.50	0.42	0.38	0.33	0.29	0.23
2920L075	1.13	1.01	0.88	0.75	0.62	0.56	0.50	0.44	0.34
2920L100	1.66	1.47	1.29	1.10	0.91	0.83	0.73	0.64	0.50
2920L125	1.89	1.68	1.46	1.25	1.04	0.94	0.83	0.73	0.56
2920L150	2.27	2.01	1.76	1.50	1.25	1.13	1.00	0.87	0.74
2920L185	2.80	2.47	2.17	1.85	1.54	1.39	1.22	1.07	0.85
2920L200	3.02	2.68	2.34	2.00	1.66	1.50	1.32	1.16	0.90
2920L200/24	3.14	2.77	2.42	2.00	1.73	1.56	1.38	1.20	0.98
2920L250	3.78	3.35	2.93	2.50	2.08	1.88	1.65	1.45	1.13
2920L260	3.64	3.25	2.91	2.60	2.26	2.08	1.95	1.74	1.48
2920L300	4.53	4.02	3.51	3.00	2.52	2.26	1.99	1.75	1.34
2920L300/15	4.20	3.85	3.44	3.00	2.69	2.50	2.31	2.12	1.83

Average Time Current Curves

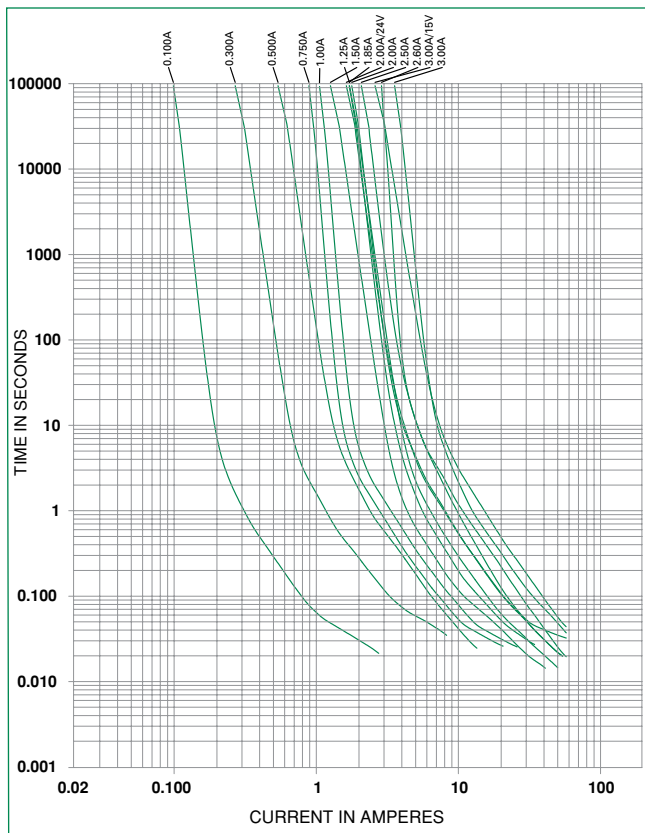

The average time current curves and temperature derating curve performance is affected by a number of variables, and these curves provided as guidance only. Customer must verify the performance in their application.

Temperature Derating Curve

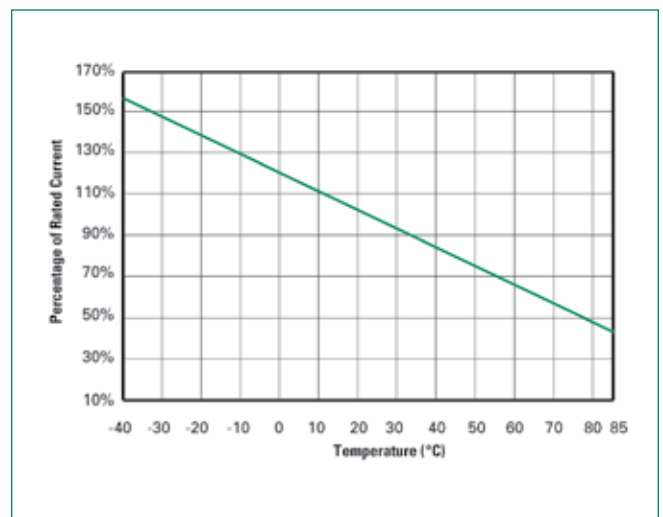

Soldering Parameters

Condition	Reflow
Peak Temp/ Duration Time	260°C / 10 Sec
Time above liquids (TAL) 220°C	60 Sec ~ 100 Sec
Preheat 120°C~ 180°C	50 Sec ~ 150 Sec
Storage Condition	0°C~35°C, ≤70%RH

- Recommended reflow methods: IR, vapor phase oven, hot air oven, N₂ environment for lead-free
- Devices are not designed to be wave soldered to the bottom side of the board.
- Recommended maximum paste thickness is 0.25mm (0.010 inch)
- Devices can be cleaned using standard industry methods and solvents.

Note: If reflow temperatures exceed the recommended profile, devices may not meet the performance requirements.

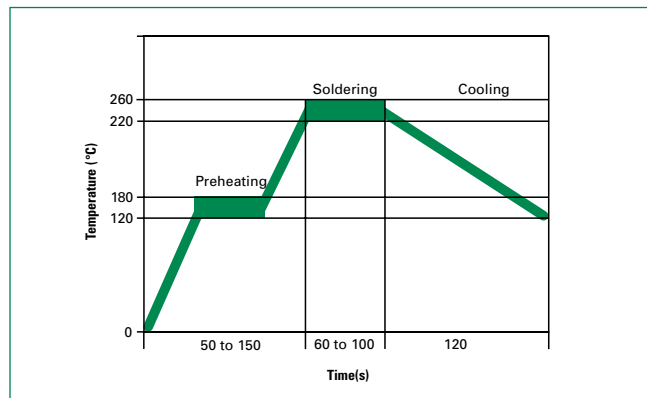

Physical Specifications

Terminal Material	Solder-Plated Copper (Solder Material: Matte Tin(Sn))
Lead Solderability	Meets EIA Specification RS186-9E, ANSI/J-STD-002 Category 3.

Environmental Specifications

Operating/Storage Temperature	-40°C to +85°C
Maximum Device Surface Temperature in Tripped State	125°C
Passive Aging	+85°C, 1000 hours ±5% typical resistance change
Humidity Aging	+85°C, 85%R.H. 1000 hours ±5% typical resistance change
Thermal Shock	MIL-STD-202 Method 107G +85°C/-40°C 20 times -30% typical resistance change
Solvent Resistance	MIL-STD-202, Method 215
Vibration	MIL-STD-883C, Method 2007.1, Condition A

Dimensions (mm)

MARKING CODE VARIES
WITH AMPERAGE AND VOLTAGE RATING
(SEE CHART)
SHOWN ARE:
- 1.5A/33V RATING (LEFT)
- 2.0A/24V RATING (RIGHT)

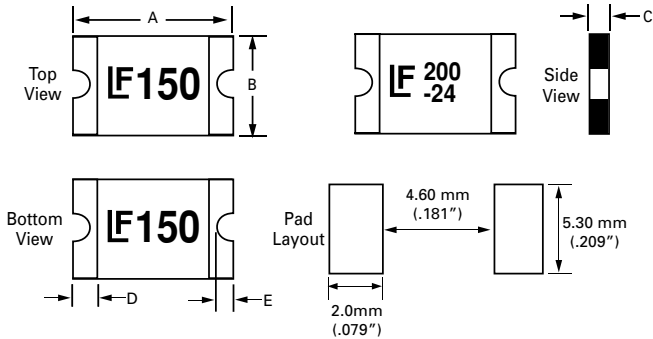

Part Number	A				B				C				D		E			
	Inches		mm		Inches		mm		Inches		mm		Inches	mm	Inches	mm	Inches	mm
	Min.	Max.	Min.	Max.	Min.	Max.	Min.	Max.	Min.	Max.	Min.	Max.	Min.	Min.	Min.	Max.	Min.	Max.
2920L030	0.26	0.31	6.73	7.98	0.19	0.21	4.8	5.44	0.03	0.05	0.75	1.25	0.01	0.3	0.01	0.08	0.25	2
2920L050	0.26	0.31	6.73	7.98	0.19	0.21	4.8	5.44	0.03	0.05	0.75	1.25	0.01	0.3	0.01	0.08	0.25	2
2920L075	0.26	0.31	6.73	7.98	0.19	0.21	4.8	5.44	0.03	0.05	0.75	1.25	0.01	0.3	0.01	0.08	0.25	2
2920L100	0.26	0.31	6.73	7.98	0.19	0.21	4.8	5.44	0.02	0.04	0.55	1	0.01	0.3	0.01	0.08	0.25	2
2920L125	0.26	0.31	6.73	7.98	0.19	0.21	4.8	5.44	0.02	0.04	0.55	1	0.01	0.3	0.01	0.08	0.25	2
2920L150	0.26	0.31	6.73	7.98	0.19	0.21	4.8	5.44	0.03	0.05	0.75	1.25	0.01	0.3	0.01	0.08	0.25	2
2920L185	0.26	0.31	6.73	7.98	0.19	0.21	4.8	5.44	0.03	0.05	0.75	1.25	0.01	0.3	0.01	0.08	0.25	2
2920L200	0.26	0.31	6.73	7.98	0.19	0.21	4.8	5.44	0.03	0.05	0.75	1.25	0.01	0.3	0.01	0.08	0.25	2
2920L200/24	0.26	0.31	6.73	7.98	0.19	0.21	4.8	5.44	0.03	0.05	0.75	1.25	0.01	0.3	0.01	0.08	0.25	2
2920L250	0.26	0.31	6.73	7.98	0.19	0.21	4.8	5.44	0.03	0.05	0.75	1.25	0.01	0.3	0.01	0.08	0.25	2
2920L260	0.26	0.31	6.73	7.98	0.19	0.21	4.8	5.44	0.02	0.04	0.55	1	0.01	0.3	0.01	0.08	0.25	2
2920L300	0.26	0.31	6.73	7.98	0.19	0.21	4.8	5.44	0.03	0.05	0.75	1.25	0.01	0.3	0.01	0.08	0.25	2
2920L300/15	0.26	0.31	6.73	7.98	0.19	0.21	4.8	5.44	0.03	0.05	0.75	1.25	0.01	0.3	0.01	0.08	0.25	2

Part Numbering System

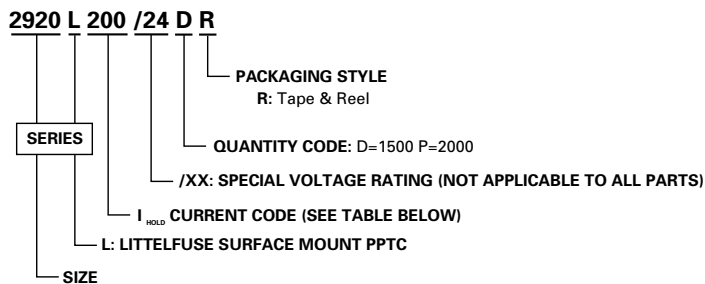

Packaging

I_{hold} (A)	I_{hold} Code	Voltage Option	Packaging Option	Quantity	Quantity & Packaging Codes
0.30	030		Tape and Reel	1500	DR
0.50	050		Tape and Reel	1500	DR
0.75	075		Tape and Reel	1500	DR
1.10	100		Tape and Reel	2000	PR
1.25	125		Tape and Reel	2000	PR
1.50	150		Tape and Reel	1500	DR
1.85	185		Tape and Reel	1500	DR
2.00	200		Tape and Reel	1500	DR
		/24	Tape and Reel	1500	DR
2.50	250		Tape and Reel	1500	DR
2.60	260		Tape and Reel	2000	PR
3.00	300		Tape and Reel	1500	DR
		/15	Tape and Reel	1500	DR

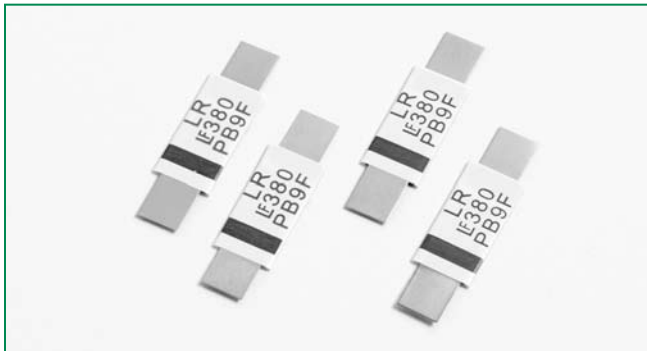

Description

The new LR series device provides reliable, noncycling protection against overcharging and short circuits events for rechargeable battery cells where resettable protection is desired.

Features

- RoHS compliant and lead-free
- Compact design saves board space
- Weldable nickel terminals
- Low resistance
- Slim, low profile design

Applications

- Rechargeable battery cell protection

Agency Approvals

AGENCY	AGENCY FILE NUMBER
	E183209
	R50082521

Electrical Characteristics

Part Number	I _{hold} (A)	I _{trip} (A)	V _{max} (Vdc)	I _{max} (A)	P _{d max.} (W)	Maximum Time To Trip		Resistance			Agency Approvals	
						Current (A)	Time (Sec.)	R _{min} (Ω)	R _{typ} (Ω)	R _{1max} (Ω)		
15LR190	1.9	3.9	15	100	1.2	9.50	5.00	0.039	0.072	0.102	X	X
15LR190S	1.9	3.9	15	100	1.2	9.50	5.00	0.039	0.072	0.102	X	X
15LR260	2.6	5.8	15	100	2.5	13.00	5.00	0.020	0.042	0.063	X	X
15LR260S	2.6	5.8	15	100	2.5	13.00	5.00	0.020	0.042	0.063	X	X
15LR380	3.8	8.3	15	100	2.5	19.00	5.00	0.013	0.026	0.037	X	X
20LR450	4.5	8.9	20	100	2.5	22.50	5.00	0.011	0.020	0.028	X	X
20LR550	5.5	10.5	20	100	2.8	27.50	5.00	0.009	0.016	0.022	X	X
20LR600	6.0	11.7	20	100	2.8	30.00	5.00	0.007	0.014	0.019	X	X
20LR730	7.3	14.1	20	100	3.3	30.00	5.00	0.006	0.012	0.015	X	X

I_{hold} = Hold current: maximum current device will pass without tripping in 20°C still air.

I_{trip} = Trip current: minimum current at which the device will trip in 20°C still air.

V_{max} = Maximum voltage device can withstand without damage at rated current (I_{max})

I_{max} = Maximum fault current device can withstand without damage at rated voltage (V_{max})

P_d = Power dissipated from device when in the tripped state at 20°C still air.

R_{min} = Minimum resistance of device in initial (un-soldered) state.

R_{typ} = Typical resistance of device in initial (un-soldered) state.

R_{1max} = Maximum resistance of device at 20°C measured one hour after tripping or reflow soldering of 260°C for 20 sec.

Caution: Operation beyond the specified rating may result in damage and possible arcing and flame.

Temperature Derating

Part Number	Ambient Operation Temperature								
	-40°C	-20°C	0°C	23°C	40°C	50°C	60°C	70°C	85°C
	Hold Current (A)								
15LR190	2.80	2.50	2.30	1.90	1.60	1.50	1.40	1.20	1.00
15LR190S	2.80	2.50	2.30	1.90	1.60	1.50	1.40	1.20	1.00
15LR260	3.80	3.40	3.10	2.60	2.20	2.00	1.90	1.70	1.40
15LR260S	3.80	3.40	3.10	2.60	2.20	2.00	1.90	1.70	1.40
15LR380	5.50	4.90	4.40	3.80	3.30	3.00	2.80	2.50	2.10
20LR450	6.50	5.80	5.30	4.50	3.90	3.60	3.30	2.90	2.50
20LR550	8.00	7.10	6.20	5.50	4.70	4.30	4.00	3.60	3.00
20LR600	8.70	7.80	7.10	6.00	5.20	4.70	4.40	3.90	3.30
20LR730	10.60	9.50	8.60	7.30	6.30	5.70	5.40	4.70	4.00

Average Time Current Curves

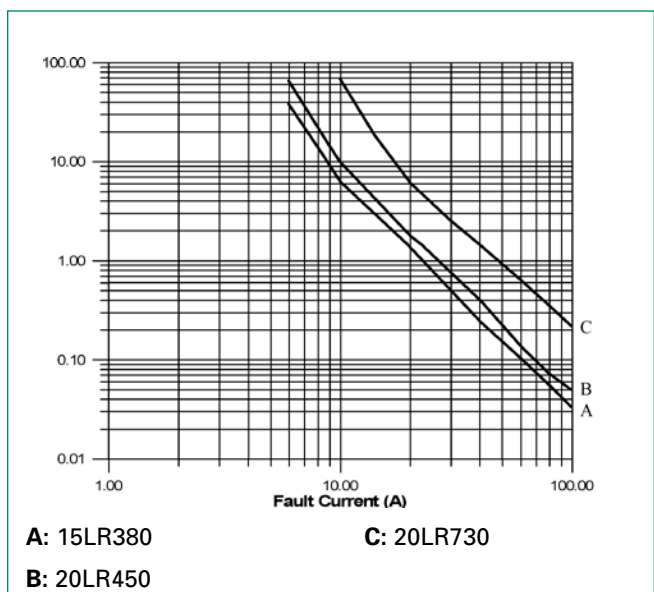

The average time current curves and temperature derating curve performance is affected by a number of variables, and these curves provided as guidance only. Customer must verify the performance in their application.

Temperature Derating Curve

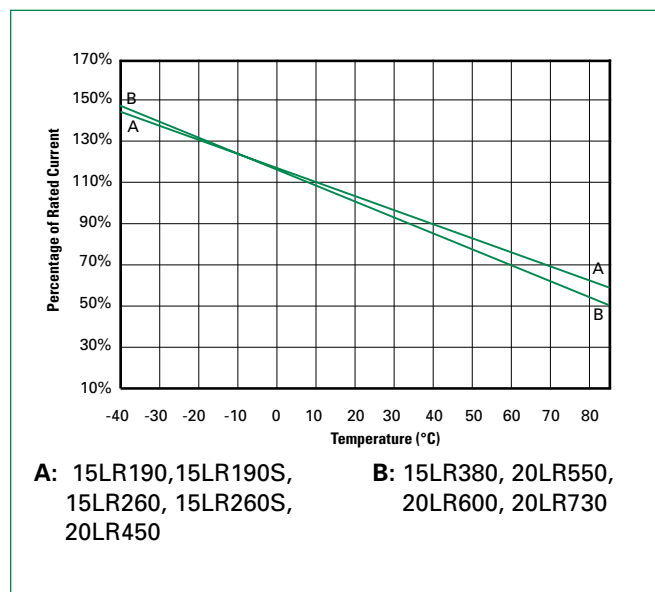

Physical Specifications

Terminal Material	0.13mm nominal thickness, quarter-hard nickel
Insulating Material	Polyester tape

Environmental Specifications

Operating/Storage Temperature	-40°C to +85°C
Maximum Device Surface Temperature in Tripped State	125°C
Passive Aging	+70°C, 1000 hours ±10% typical resistance change
Humidity Aging	+85°C, 85% R.H. 70days ±5% typical resistance change
Vibration	MIL-STD-883C, Method 2007.1, Condition A No change

Dimensions

Figure 1

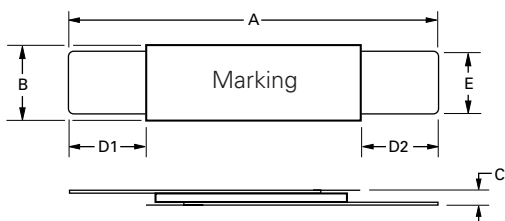
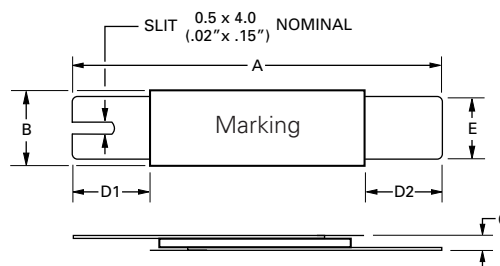
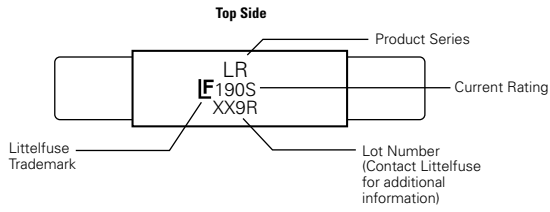

Figure 2



Part Number	A		B		C		D1		D2		E		Figure								
	Inches	mm	Inches	mm	Inches	mm	Inches	mm	Inches	mm	Inches	mm									
	Min.	Max.	Min.	Max.	Min.	Max.	Min.	Max.	Min.	Max.	Min.	Max.									
15LR190	0.78	0.87	19.90	22.10	0.19	0.22	4.90	5.50	0.02	0.04	0.60	1.00	0.22	5.50	0.22	5.50	0.01	0.22	3.90	4.10	1
15LR190S	0.78	0.87	19.90	22.10	0.19	0.22	4.90	5.50	0.02	0.04	0.60	1.00	0.22	5.50	0.22	5.50	0.01	0.22	3.90	4.10	2
15LR260	0.82	0.91	20.90	23.10	0.19	0.22	4.90	5.50	0.02	0.04	0.60	1.00	0.16	4.10	0.16	4.10	0.01	0.16	3.90	4.10	1
15LR260S	0.82	0.91	20.90	23.10	0.19	0.22	4.90	5.50	0.02	0.04	0.60	1.00	0.16	4.10	0.16	4.10	0.01	0.16	3.90	4.10	2
15LR380S	0.94	1.02	24.00	26.00	0.27	0.30	6.90	7.50	0.02	0.04	0.60	1.00	0.16	4.10	0.16	4.10	0.01	0.16	4.90	5.10	1
20LR450S	0.94	1.02	24.00	26.00	0.39	0.41	9.90	10.50	0.02	0.04	0.60	1.00	0.21	5.30	0.21	5.30	0.01	0.21	5.90	6.10	1
20LR550S	1.38	1.46	35.00	37.00	0.27	0.30	6.90	7.50	0.02	0.04	0.60	1.00	0.21	5.30	0.21	5.30	0.01	0.21	4.90	5.10	1
20LR600S	0.94	1.02	24.00	26.00	0.55	0.57	13.90	14.50	0.02	0.04	0.60	1.00	0.16	4.10	0.16	4.10	0.01	0.16	5.90	6.10	1
20LR730S	1.07	1.15	27.10	29.10	0.55	0.57	13.90	14.50	0.02	0.04	0.60	1.00	0.16	4.10	0.16	4.10	0.01	0.16	5.90	6.10	1

Part Marking System



Part Numbering System

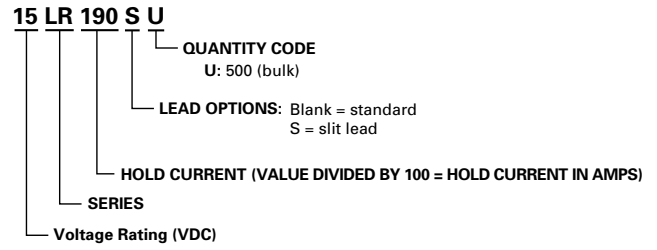

Packaging

I_{hold} (A)	Packaging Option	Quantity	Quantity & Packaging Codes
All Ratings	Bulk	500	U

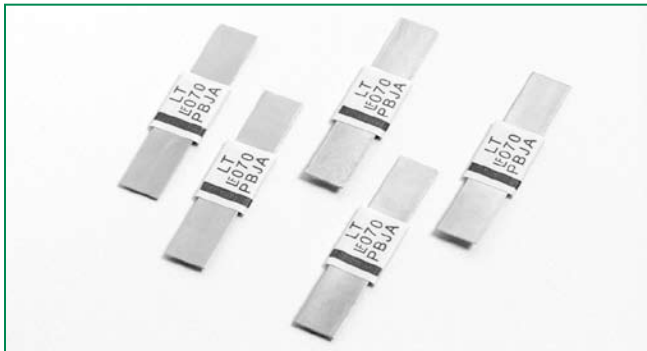

Description

The new LT series device provides reliable, noncycling protection against overcharging and short circuits events for rechargeable battery cells where resettable protection is desired.

Features

- RoHS compliant and lead-free
- Weldable nickel terminals
- Compact design saves board space
- Low resistance
- Provides overcurrent protection at 100°C trip temperature

Agency Approvals

AGENCY	AGENCY FILE NUMBER
	E183209
	R50082521

Applications

- Rechargeable battery cell protection
 - Mobile phones
 - Laptop computers

Electrical Characteristics

Part Number	I _{hold} (A)	I _{trip} (A)	V _{max} (Vdc)	I _{max} (A)	P _{d max.} (W)	Maximum Time To Trip		Resistance			Agency Approvals	
						Current (A)	Time (Sec.)	R _{min} (Ω)	R _{typ} (Ω)	R _{1max} (Ω)		
15LT070	0.7	1.5	15	100	1.0	3.50	5.00	0.100	0.200	0.340	X	X
15LT070S	0.7	1.5	15	100	1.0	3.50	5.00	0.100	0.200	0.340	X	X
24LT100	1.0	2.5	24	100	1.5	5.00	7.00	0.070	0.130	0.260	X	X
24LT100S	1.0	2.5	24	100	1.5	5.00	7.00	0.070	0.130	0.260	X	X
24LT100SS	1.0	2.5	24	100	1.5	5.00	7.00	0.070	0.130	0.260	X	X
24LT180	1.8	3.8	24	100	2.0	9.00	2.90	0.040	0.068	0.120	X	X
24LT180S	1.8	3.8	24	100	2.0	9.00	2.90	0.040	0.068	0.120	X	X
24LT180SS	1.8	3.8	24	100	2.0	9.00	2.90	0.040	0.068	0.120	X	X
24LT190	1.9	4.2	24	100	1.9	10.00	3.00	0.030	0.057	0.100	X	X
24LT190S	1.9	4.2	24	100	1.9	10.00	3.00	0.030	0.057	0.100	X	X
24LT260	2.6	5.2	24	100	2.3	13.0	5.0	0.025	0.042	0.076	X	X
24LT300	3.0	6.3	24	100	2.0	15.0	4.0	0.015	0.031	0.055	X	X
24LT310	3.1	6.0	24	100	2.5	16.0	5.0	0.018	0.030	0.055	X	X
24LT340	3.4	6.8	24	100	2.7	17.0	5.0	0.016	0.027	0.050	X	X

I_{hold} = Hold current: maximum current device will pass without tripping in 20°C still air.

I_{trip} = Trip current: minimum current at which the device will trip in 20°C still air.

V_{max} = Maximum voltage device can withstand without damage at rated current (I_{max})

I_{max} = Maximum fault current device can withstand without damage at rated voltage (V_{max})

P_d = Power dissipated from device when in the tripped state at 20°C still air.

R_{min} = Minimum resistance of device in initial (un-soldered) state.

R_{typ} = Typical resistance of device in initial (un-soldered) state.

R_{1max} = Maximum resistance of device at 20°C measured one hour after tripping or reflow soldering of 260°C for 20 sec.

Caution: Operation beyond the specified rating may result in damage and possible arcing and flame.

Temperature Derating

Part Number	Ambient Operation Temperature								
	-40°C	-20°C	0°C	20°C	40°C	50°C	60°C	70°C	85°C
	Hold Current (A)								
15LT070	1.20	1.09	0.85	0.70	0.50	0.45	0.35	0.28	0.16
15LT070S	1.20	1.09	0.85	0.70	0.50	0.45	0.35	0.28	0.16
24LT100	1.86	1.60	1.40	1.00	0.80	0.70	0.60	0.44	0.23
24LT100S	1.86	1.60	1.40	1.00	0.83	0.70	0.60	0.44	0.23
24LT100SS	1.86	1.60	1.40	1.00	0.83	0.70	0.60	0.44	0.23
24LT180	3.13	2.68	2.20	1.80	1.33	1.10	0.90	0.65	0.36
24LT180S	3.13	2.68	2.20	1.80	1.33	1.10	0.90	0.65	0.36
24LT180SS	3.13	2.68	2.20	1.80	1.33	1.10	0.90	0.65	0.36
24LT190	3.32	2.86	2.40	1.90	1.48	1.25	1.10	0.79	0.43
24LT260	4.30	3.72	3.10	2.60	1.98	1.69	1.40	1.11	0.60
24LT300	5.10	4.40	3.70	3.00	2.30	1.95	1.60	1.25	0.69
24LT310	5.36	4.58	3.70	3.10	2.36	2.01	1.70	1.30	0.71
24LT340	5.52	4.79	4.00	3.40	2.60	2.24	1.90	1.51	0.78

Average Time Current Curves

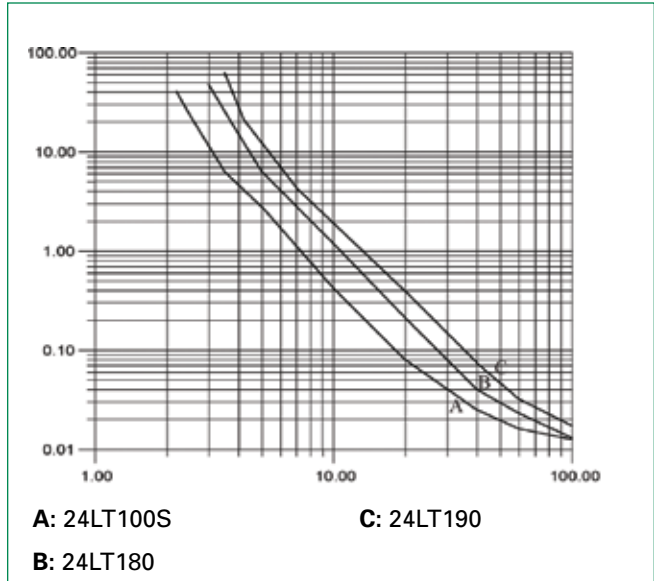

Temperature Derating Curve

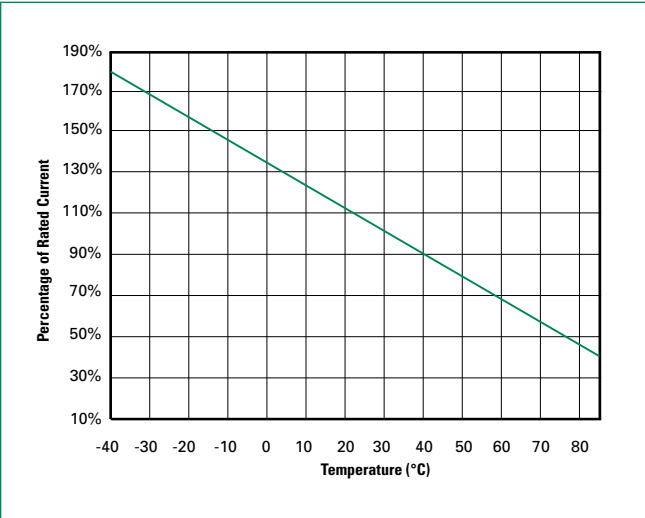

The average time current curves and temperature derating curve performance is affected by a number of variables, and these curves provided as guidance only. Customer must verify the performance in their application.

Physical Specifications

Terminal Material	0.13mm nominal thickness, quarter-hard nickel
Insulating Material	Polyester tape

Environmental Specifications

Operating/Storage Temperature	-40°C to +85°C
Maximum Device Surface Temperature in Tripped State	125°C
Passive Aging	+70°C, 1000 hours ±10% typical resistance change
Humidity Aging	+85°C, 85%R.H. 7days ±5% typical resistance change
Vibration	MIL-LTD-883C, Condition A No change

Dimensions

Figure 1

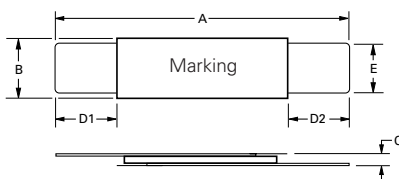

Figure 2

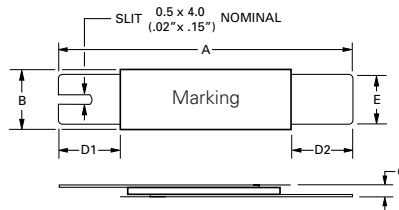
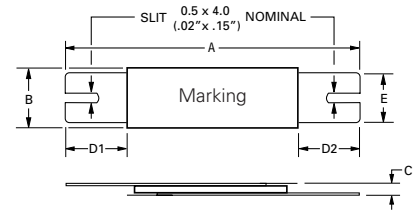

Figure 3



Part Number	A				B				C				D1		D2		E				Fig.
	Inches		mm		Inches		mm		Inches		mm		in.	mm	in.	mm	Inches		mm		
	Min.	Max.	Min.	Max.	Min.	Max.	Min.	Max.	Min.	Max.	Min.	Max.	Min.	Max.	Min.	Max.	Min.	Max.	Min.	Max.	
15LT070	0.78	0.87	19.9	22.1	0.19	0.20	4.9	5.2	0.03	0.05	0.7	1.2	0.22	5.5	0.22	5.5	0.01	0.22	3.9	4.1	1
15LT070S	0.78	0.87	19.9	22.1	0.19	0.20	4.9	5.2	0.03	0.05	0.7	1.2	0.22	5.5	0.22	5.5	0.01	0.22	3.9	4.1	2
24LT100	0.82	0.91	20.9	23.1	0.19	0.20	4.9	5.2	0.02	0.04	0.6	1	0.16	4.1	0.16	4.1	0.01	0.16	3.9	4.1	1
24LT100S	0.82	0.91	20.9	23.1	0.19	0.20	4.9	5.2	0.02	0.04	0.6	1	0.16	4.1	0.16	4.1	0.01	0.16	3.9	4.1	2
24LT100SS	0.82	0.91	20.9	23.1	0.19	0.20	4.9	5.2	0.02	0.04	0.6	1	0.16	4.1	0.16	4.1	0.01	0.16	3.9	4.1	3
24LT180	0.94	1.02	24	26	0.19	0.20	4.9	5.2	0.02	0.04	0.6	1	0.16	4.1	0.16	4.1	0.01	0.16	3.9	4.1	1
24LT180S	0.94	1.02	24	26	0.19	0.20	4.9	5.2	0.02	0.04	0.6	1	0.16	4.1	0.16	4.1	0.01	0.16	3.9	4.1	2
24LT180SS	0.94	1.02	24	26	0.19	0.20	4.9	5.2	0.02	0.04	0.6	1	0.16	4.1	0.16	4.1	0.01	0.16	3.9	4.1	3
24LT190	0.84	0.92	21.3	23.4	0.40	0.43	10.2	11	0.02	0.04	0.5	1	0.20	5	0.20	5	0.01	0.20	4.8	5.4	1
24LT190S	0.84	0.92	21.3	23.4	0.40	0.43	10.2	11	0.02	0.04	0.5	1	0.20	5	0.20	5	0.01	0.20	4.8	5.4	2
24LT260	0.94	1.02	24	26	0.43	0.47	10.8	11.9	0.02	0.04	0.6	1	0.20	5	0.20	5	0.01	0.20	5.9	6.1	1
24LT300	1.12	1.25	28.4	31.8	0.51	0.53	13	13.5	0.02	0.04	0.5	1.1	0.25	6.3	0.25	6.3	0.00	0.25	6	6.6	1
24LT310	0.94	1.02	24	26	0.58	0.63	14.8	15.9	0.02	0.04	0.6	1	0.20	5	0.20	5	0.01	0.20	5.9	6.1	1
24LT340	0.94	1.02	24	26	0.58	0.63	14.8	15.9	0.02	0.04	0.6	1	0.20	5	0.20	5	0.01	0.20	5.9	6.1	1

Physical Specifications

Terminal Material	0.13mm nominal thickness, quarter-hard nickel
Insulating Material	Polyester tape

Environmental Specifications

Operating/Storage Temperature	-40°C to +85°C
Maximum Device Surface Temperature in Tripped State	125°C
Passive Aging	+70°C, 1000 hours ±10% typical resistance change
Humidity Aging	+85°C, 85%R.H. 7days ±5% typical resistance change
Vibration	MIL-LTD-883C, Condition A No change

Dimensions

Figure 1

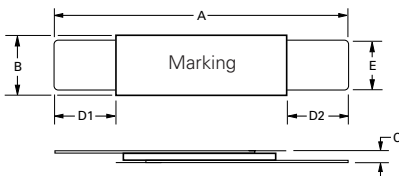

Figure 2

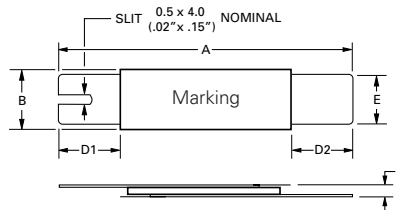
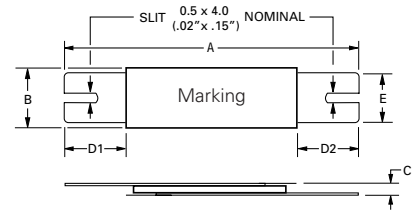
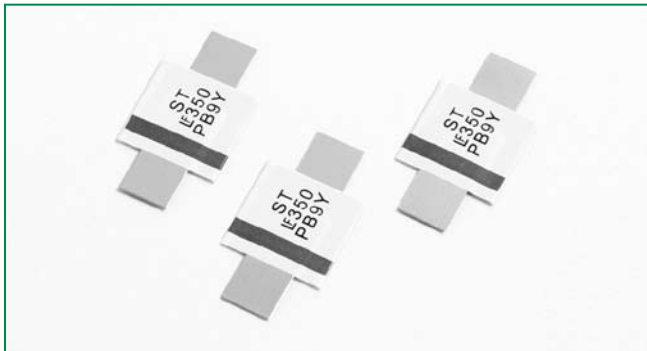

Figure 3



Part Number	A				B				C				D1		D2		E				Fig.
	Inches		mm		Inches		mm		Inches		mm		in.	mm	in.	mm	Inches		mm		
	Min.	Max.	Min.	Max.	Min.	Max.	Min.	Max.	Min.	Max.	Min.	Max.	Min.	Min.	Min.	Min.	Min.	Max.	Min.	Max.	
15LT070	0.78	0.87	19.9	22.1	0.19	0.20	4.9	5.2	0.03	0.05	0.7	1.2	0.22	5.5	0.22	5.5	0.01	0.22	3.9	4.1	1
15LT070S	0.78	0.87	19.9	22.1	0.19	0.20	4.9	5.2	0.03	0.05	0.7	1.2	0.22	5.5	0.22	5.5	0.01	0.22	3.9	4.1	2
24LT100	0.82	0.91	20.9	23.1	0.19	0.20	4.9	5.2	0.02	0.04	0.6	1	0.16	4.1	0.16	4.1	0.01	0.16	3.9	4.1	1
24LT100S	0.82	0.91	20.9	23.1	0.19	0.20	4.9	5.2	0.02	0.04	0.6	1	0.16	4.1	0.16	4.1	0.01	0.16	3.9	4.1	2
24LT100SS	0.82	0.91	20.9	23.1	0.19	0.20	4.9	5.2	0.02	0.04	0.6	1	0.16	4.1	0.16	4.1	0.01	0.16	3.9	4.1	3
24LT180	0.94	1.02	24	26	0.19	0.20	4.9	5.2	0.02	0.04	0.6	1	0.16	4.1	0.16	4.1	0.01	0.16	3.9	4.1	1
24LT180S	0.94	1.02	24	26	0.19	0.20	4.9	5.2	0.02	0.04	0.6	1	0.16	4.1	0.16	4.1	0.01	0.16	3.9	4.1	2
24LT180SS	0.94	1.02	24	26	0.19	0.20	4.9	5.2	0.02	0.04	0.6	1	0.16	4.1	0.16	4.1	0.01	0.16	3.9	4.1	3
24LT190	0.84	0.92	21.3	23.4	0.40	0.43	10.2	11	0.02	0.04	0.5	1	0.20	5	0.20	5	0.01	0.20	4.8	5.4	1
24LT190S	0.84	0.92	21.3	23.4	0.40	0.43	10.2	11	0.02	0.04	0.5	1	0.20	5	0.20	5	0.01	0.20	4.8	5.4	2
24LT260	0.94	1.02	24	26	0.43	0.47	10.8	11.9	0.02	0.04	0.6	1	0.20	5	0.20	5	0.01	0.20	5.9	6.1	1
24LT300	1.12	1.25	28.4	31.8	0.51	0.53	13	13.5	0.02	0.04	0.5	1.1	0.25	6.3	0.25	6.3	0.00	0.25	6	6.6	1
24LT310	0.94	1.02	24	26	0.58	0.63	14.8	15.9	0.02	0.04	0.6	1	0.20	5	0.20	5	0.01	0.20	5.9	6.1	1
24LT340	0.94	1.02	24	26	0.58	0.63	14.8	15.9	0.02	0.04	0.6	1	0.20	5	0.20	5	0.01	0.20	5.9	6.1	1



Description

The new ST series device provides reliable, noncycling protection against overcharging and short circuits events for rechargeable battery cells where resettable protection is desired.

Features

- RoHS compliant and lead-free
- Weldable nickel terminals
- Low resistance
- Provides overcurrent protection at 125°C trip temperature

Applications

- Rechargeable battery cell protection

Agency Approvals

AGENCY	AGENCY FILE NUMBER
	E183209
	R50082521

Electrical Characteristics

Part Number	I _{hold} (A)	I _{trip} (A)	V _{max} (Vdc)	I _{max} (A)	P _{d max.} (W)	Maximum Time To Trip		Resistance			Agency Approvals	
						Current (A)	Time (Sec.)	R _{min} (Ω)	R _{typ} (Ω)	R _{1max} (Ω)		
15ST120	1.2	2.7	15	100	1.2	6.00	5.00	0.085	0.160	0.220	X	X
15ST120S	1.2	2.7	15	100	1.2	6.00	5.00	0.085	0.160	0.220	X	X
15ST175	1.75	3.8	15	100	2.5	8.75	5.00	0.050	0.090	0.120	X	X
15ST175S	1.75	3.8	15	100	2.5	8.75	5.00	0.050	0.090	0.120	X	X

I_{hold} = Hold current: maximum current device will pass without tripping in 20°C still air.

I_{trip} = Trip current: minimum current at which the device will trip in 20°C still air.

V_{max} = Maximum voltage device can withstand without damage at rated current (I_{max})

I_{max} = Maximum fault current device can withstand without damage at rated voltage (V_{max})

P_d = Power dissipated from device when in the tripped state at 20°C still air.

R_{min} = Minimum resistance of device in initial (un-soldered) state.

R_{typ} = Typical resistance of device in initial (un-soldered) state.

R_{1max} = Maximum resistance of device at 20°C measured one hour after tripping or reflow soldering of 260°C for 20 sec.

Caution: Operation beyond the specified rating may result in damage and possible arcing and flame.

Temperature Derating

Part Number	Ambient Operation Temperature								
	-40°C	-20°C	0°C	23°C	40°C	50°C	60°C	70°C	85°C
15ST120	1.90	1.70	1.50	1.20	1.00	0.90	0.80	0.70	0.50
15ST120S	1.90	1.70	1.50	1.20	1.00	0.90	0.80	0.70	0.50
15ST175	2.50	2.30	2.00	1.75	1.50	1.30	1.20	1.10	0.90
15ST175S	2.50	2.30	2.00	1.75	1.50	1.30	1.20	1.10	0.90

Average Time Current Curves

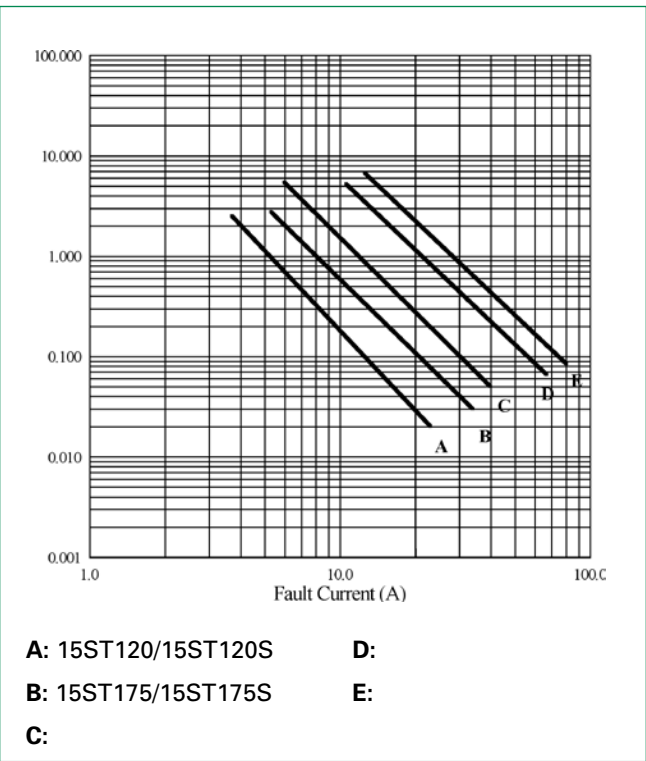

Temperature Derating Curve

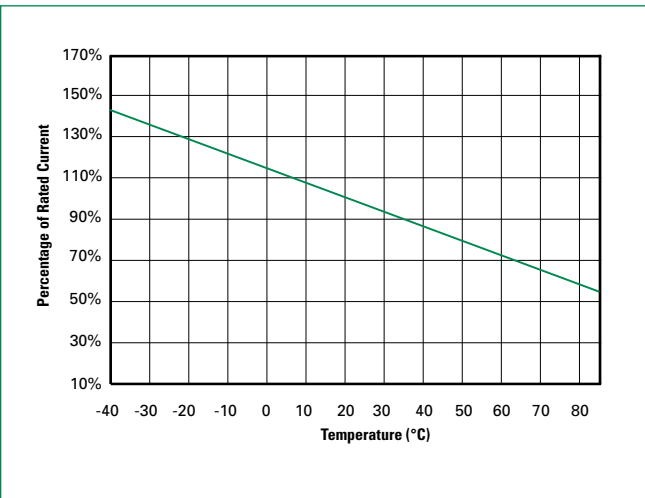

The average time current curves and temperature derating curve performance is affected by a number of variables, and these curves provided as guidance only. Customer must verify the performance in their application.

Physical Specifications

Lead Material	0.13mm nominal thickness, quarter-hard nickel
Insulating Material	Polyester tape

Environmental Specifications

Operating/Storage Temperature	-40°C to +85°C
Maximum Device Surface Temperature in Tripped State	125°C
Passive Aging	+70°C, 1000 hours ±5% typical resistance change
Humidity Aging	+85°C, 85% R.H. 7 days ±5% typical resistance change
Vibration	MIL-STD-883C, Condition A No change

Dimensions

Figure 1

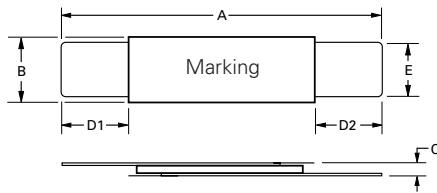
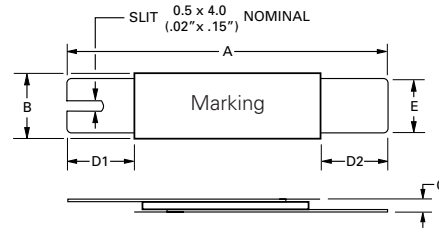
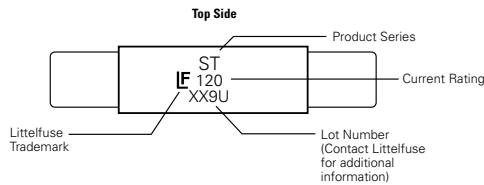

Figure 2



Part Number	A		B		C		D1		D2		E		Fig.								
	Inches	mm	Inches	mm	Inches	mm	Inches	mm	Inches	mm	Inches	mm									
	Min.	Max.	Min.	Max.	Min.	Max.	Min.	Max.	Min.	Max.	Min.	Max.									
15ST120	0.78	0.87	19.9	22.1	0.19	0.20	4.9	5.2	0.02	0.04	0.6	1	0.22	5.5	0.22	5.5	0.01	0.22	3.9	4.1	1
15ST120S	0.78	0.87	19.9	22.1	0.19	0.20	4.9	5.2	0.02	0.04	0.6	1	0.22	5.5	0.22	5.5	0.01	0.22	3.9	4.1	2
15ST175	0.82	0.91	20.9	23.1	0.19	0.20	4.9	5.2	0.02	0.04	0.6	1	0.16	4.1	0.16	4.1	0.01	0.16	3.9	4.1	1
15ST175S	0.82	0.91	20.9	23.1	0.19	0.20	4.9	5.2	0.02	0.04	0.6	1	0.16	4.1	0.16	4.1	0.01	0.16	3.8	4.2	2

Part Marking System



Part Numbering System

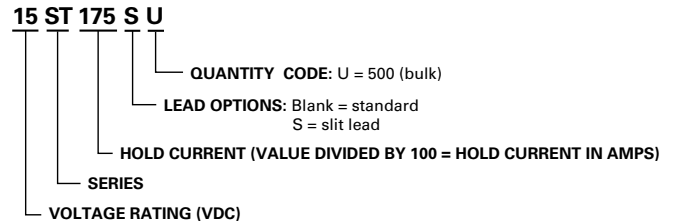

Packaging

I _{hold} (A)	Packaging Option	Quantity	Quantity & Packaging Codes
All Ratings	Bulk	500	U

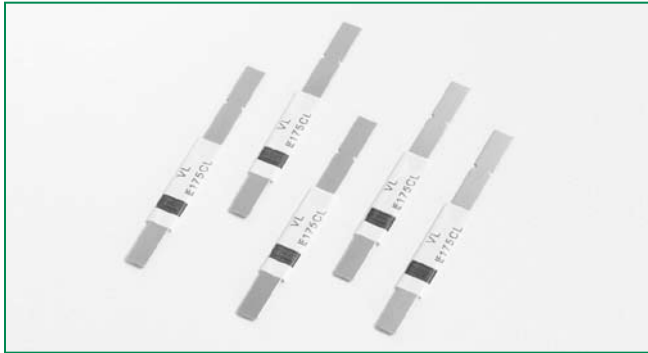

Description

The new VL series device provides reliable, noncycling protection against overcharging and short circuits events for rechargeable battery cells where resettable protection is desired.

Features

- RoHS compliant and lead-free
- Compact design saves board space
- Weldable nickel terminals
- Low resistance
- Slim, low profile design

Applications

- Rechargeable battery cell protection

Agency Approvals

AGENCY	AGENCY FILE NUMBER
	E183209
	R50082521

Electrical Characteristics

Part Number	I _{hold} (A)	I _{trip} (A)	V _{max} (Vdc)	I _{max} (A)	P _{d max.} (W)	Maximum Time To Trip		Resistance			Agency Approvals	
						Current (A)	Time (Sec.)	R _{min} (Ω)	R _{typ} (Ω)	R _{1max} (Ω)		
12VL170	1.70	4.10	12	100	1.4	8.50	5.00	0.018	0.032	0.064	X	X
12VL175L	1.75	4.20	12	100	1.4	8.75	5.00	0.017	0.031	0.062	X	X
12VL175XL	1.75	4.20	12	100	1.4	8.75	5.00	0.017	0.031	0.062	X	X
12VL230	2.30	5.00	12	100	1.5	10.00	5.00	0.012	0.018	0.036	X	X

I_{hold} = Hold current: maximum current device will pass without tripping in 20°C still air.
 I_{trip} = Trip current: minimum current at which the device will trip in 20°C still air.
 V_{max} = Maximum voltage device can withstand without damage at rated current (I_{max})
 I_{max} = Maximum fault current device can withstand without damage at rated voltage (V_{max})
 P_d = Power dissipated from device when in the tripped state at 20°C still air.
 R_{min} = Minimum resistance of device in initial (un-soldered) state.

R_{typ} = Typical resistance of device in initial (un-soldered) state.
 R_{1max} = Maximum resistance of device at 20°C measured one hour after tripping or reflow soldering of 260°C for 20 sec.

Caution: Operation beyond the specified rating may result in damage and possible arcing and flame.

Temperature Derating

Part Number	Ambient Operation Temperature							
	-40°C	-20°C	0°C	25°C	40°C	50°C	60°C	70°C
12VL170	3.5	2.9	2.4	1.70	1.2	1.0	0.7	0.3
12VL175L	3.5	2.9	2.4	1.75	1.3	1.0	0.8	0.3
12VL175XL	3.5	2.9	2.4	1.75	1.3	1.0	0.8	0.3
12VL230	5.0	4.2	3.4	2.30	1.7	1.3	0.9	0.4

Average Time Current Curves

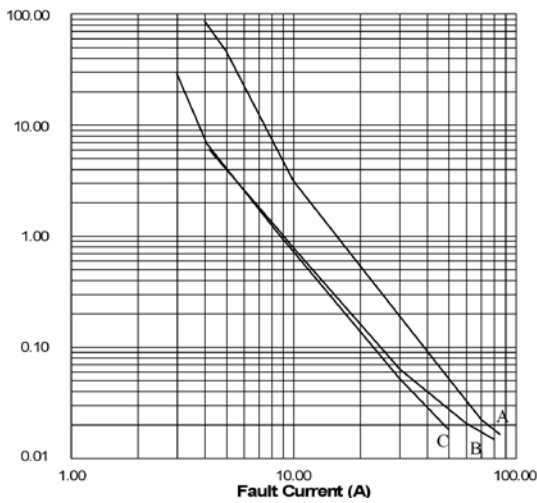

A: 12VL230 **C:** VLD170F
B: 12VL175L, 12VL175XL

Temperature Derating Curve

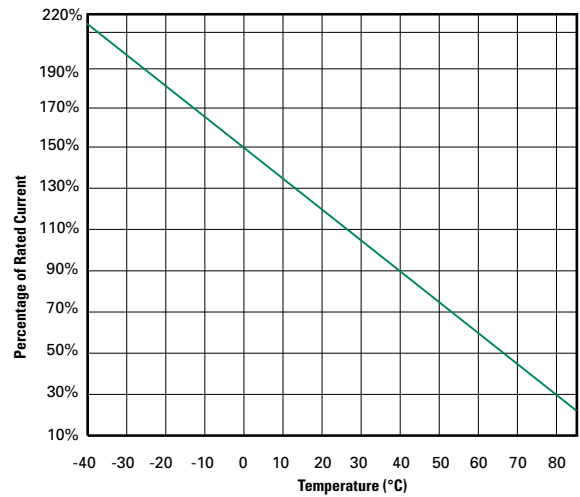

The average time current curves and temperature derating curve performance is affected by a number of variables, and these curves provided as guidance only. Customer must verify the performance in their application.

Physical Specifications

Terminal Material	0.13mm nominal thickness, quarter-hard nickel
Insulating Material	Polyester tape

Environmental Specifications

Operating/Storage Temperature	-40°C to +85°C
Passive Aging	+60°C, 1000 hours ±20% typical resistance change -40°C, 1000 hours ±5% typical resistance change
Humidity Aging	+60°C, 95%R.H. 1000 hours ±30% typical resistance change
Thermal Shock	MIL-STD-202G, Method 107G +85°C to -40°C 10 times ±5% typical resistance change
Vibration	MIL-STD-883C, Method 2026 No change

Dimensions

Figure 1

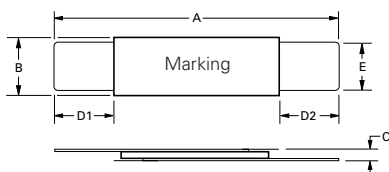
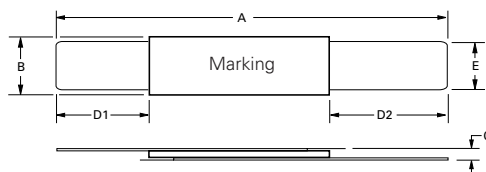
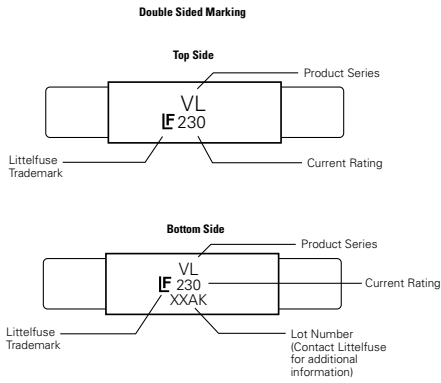

Figure 2



Part Number	A		B		C		D1		D2		E		Fig.												
	Inches	mm	Inches	mm	Inches	mm	Inches	mm	Inches	mm	Inches	mm													
	Min.	Max.	Min.	Max.	Min.	Max.	Min.	Max.	Min.	Max.	Min.	Max.													
12VL170	0.82	0.91	20.80	23.20	0.14	0.15	3.50	3.90	--	0.03	--	0.80	0.18	0.26	4.50	6.50	0.18	0.26	4.50	6.50	0.01	0.26	2.40	2.60	1
12VL175L	1.15	1.25	29.30	31.70	0.11	0.13	2.90	3.30	--	0.03	--	0.80	0.20	0.27	5.20	6.80	0.39	0.49	10.00	12.50	0.02	0.49	2.40	2.60	2
12VL175XL	1.00	1.11	25.50	28.20	0.14	0.15	3.50	3.90	--	0.03	--	0.80	0.34	0.41	8.70	10.30	0.22	0.29	5.70	7.30	0.01	0.29	2.40	2.60	1
12VL230	0.82	0.91	20.90	23.10	0.19	0.21	4.90	5.30	--	0.03	--	0.80	0.16	0.23	4.10	5.80	0.16	0.23	4.10	5.80	0.01	0.23	3.90	4.10	2

Part Marking System



Part Numbering System

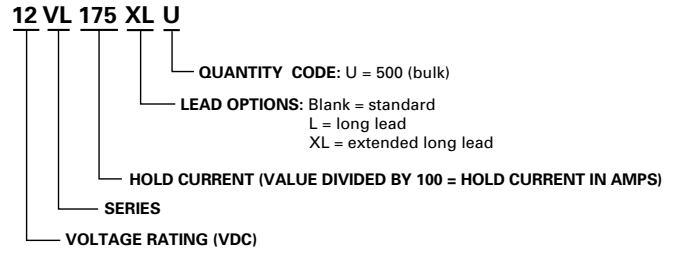

Packaging

I_{hold} (A)	Packaging Option	Quantity	Quantity & Packaging Codes
All Ratings	Bulk	500	U



Description

The new VT series device provides reliable, noncycling protection against overcharging and short circuits events for rechargeable battery cells where resettable protection is desired.

Features

- RoHS compliant and lead-free
- Compact design saves board space
- Weldable nickel terminals
- Low resistance
- Slim, low profile design

Applications

- Rechargeable battery cell protection
 - Mobile phones
 - Laptop computers

Agency Approvals

AGENCY	AGENCY FILE NUMBER
	E183209
	R50082521

Electrical Characteristics

Part Number	I _{hold} (A)	I _{trip} (A)	V _{max} (Vdc)	I _{max} (A)	P _d max. (W)	Maximum Time To Trip		Resistance			Agency Approvals	
						Current (A)	Time (Sec.)	R _{min} (Ω)	R _{typ} (Ω)	R _{1max} (Ω)		
16VT170	1.70	3.40	16	100	1.4	8.50	3.00	0.030	0.052	0.105	X	X
16VT170XS	1.70	3.40	16	100	1.4	8.50	3.00	0.030	0.052	0.105	X	X
16VT175	1.75	3.80	16	100	1.4	9.00	3.00	0.025	0.045	0.090	X	X
16VT175S	1.75	3.80	16	100	1.4	9.00	3.00	0.025	0.045	0.090	X	X
16VT175L	1.75	3.80	16	100	1.4	9.00	3.00	0.025	0.045	0.090	X	X
16VT175XL	1.75	3.80	16	100	1.4	8.75	5.00	0.029	0.051	0.102	X	X
16VT175EL	1.75	3.60	16	100	1.4	8.75	5.00	0.029	0.051	0.102	X	X
16VT175NEL	1.75	3.60	16	100	1.4	8.75	5.00	0.029	0.051	0.102	X	X
16VT200	2.00	4.50	16	100	1.5	10.00	4.00	0.021	0.039	0.080	X	X
16VT200S	2.00	4.50	16	100	1.5	10.00	4.00	0.021	0.039	0.080	X	X
16VT200UL	2.00	4.70	16	100	1.5	10.00	5.00	0.022	0.039	0.076	X	X
16VT210	2.10	4.70	16	100	1.5	10.00	5.00	0.018	0.030	0.060	X	X
16VT210S	2.10	4.70	16	100	1.5	10.00	5.00	0.018	0.030	0.060	X	X
16VT210SS	2.10	4.70	16	100	1.5	10.00	5.00	0.018	0.030	0.060	X	X
16VT210L	2.10	4.70	16	100	1.5	10.00	5.00	0.018	0.030	0.060	X	X
16VT210NL	2.10	4.70	16	100	1.5	10.00	5.00	0.018	0.035	0.065	X	X
16VT210UL	2.10	4.70	16	100	1.5	10.00	5.00	0.018	0.035	0.065	X	X
16VT240	2.40	5.40	16	100	1.5	12.00	4.00	0.015	0.026	0.052	X	X

I_{hold} = Hold current: maximum current device will pass without tripping in 20°C still air.
 I_{trip} = Trip current: minimum current at which the device will trip in 20°C still air.
 V_{max} = Maximum voltage device can withstand without damage at rated current (I_{max})
 I_{max} = Maximum fault current device can withstand without damage at rated voltage (V_{max})
 P_d = Power dissipated from device when in the tripped state at 20°C still air.
 R_{min} = Minimum resistance of device in initial (un-soldered) state.

R_{typ} = Typical resistance of device in initial (un-soldered) state.
 R_{1max} = Maximum resistance of device at 20°C measured one hour after tripping or reflow soldering of 260°C for 20 sec.

Caution: Operation beyond the specified rating may result in damage and possible arcing and flame.

Temperature Derating

Part Number	Ambient Operation Temperature								
	-40°C	-20°C	0°C	23°C	40°C	50°C	60°C	70°C	85°C
	Hold Current (A)								
16VT170	3.20	2.70	2.20	1.70	1.30	1.00	0.80	0.50	0.10
16VT170XS	3.20	2.70	2.20	1.70	1.30	1.00	0.80	0.50	0.10
16VT175	3.20	2.70	2.20	1.75	1.30	1.00	0.80	0.50	0.10
16VT175S	3.20	2.70	2.20	1.75	1.30	1.00	0.80	0.50	0.10
16VT175L	3.20	2.70	2.20	1.75	1.30	1.00	0.80	0.50	0.10
16VT175XL	3.20	2.70	2.20	1.75	1.30	1.00	0.80	0.50	0.10
16VT175EL	3.20	2.70	2.20	1.75	1.30	1.00	0.80	0.50	0.10
16VT175NEL	3.20	2.70	2.20	1.75	1.30	1.00	0.80	0.50	0.10
16VT200	3.70	3.20	2.60	2.00	1.50	1.20	0.90	0.50	0.10
16VT200S	3.70	3.20	2.60	2.00	1.50	1.20	0.90	0.50	0.10
16VT200UL	3.70	3.20	2.60	2.00	1.50	1.20	0.90	0.50	0.10
16VT210	4.10	3.50	2.90	2.10	1.60	1.30	1.00	0.70	0.10
16VT210S	4.10	3.50	2.90	2.10	1.60	1.30	1.00	0.70	0.10
16VT210SS	4.10	3.50	2.90	2.10	1.60	1.30	1.00	0.70	0.10
16VT210L	4.10	3.50	2.90	2.10	1.60	1.30	1.00	0.70	0.10
16VT210NL	4.10	3.50	2.90	2.10	1.60	1.30	1.00	0.70	0.10
16VT210UL	4.10	3.50	2.90	2.10	1.60	1.30	1.00	0.70	0.10
16VT240	4.40	3.70	3.10	2.40	1.80	1.50	1.20	0.90	0.10

Average Time Current Curves

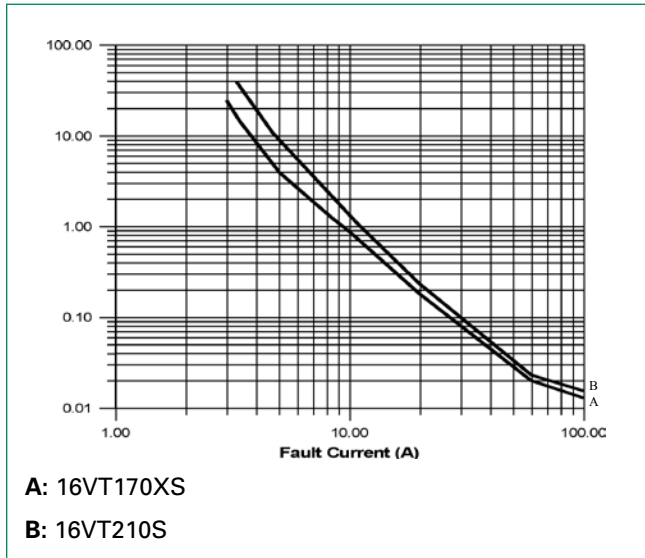

The average time current curves and temperature derating curve performance is affected by a number of variables, and these curves provided as guidance only. Customer must verify the performance in their application.

Temperature Derating Curve

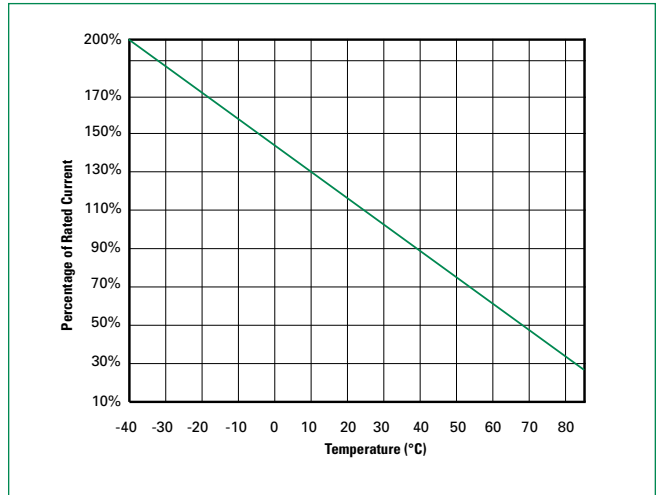

Physical Specifications

Terminal Material	0.13mm nominal thickness, quarter-hard nickel
Insulating Material	Polyester tape

Environmental Specifications

Operating/Storage Temperature	-40°C to +85°C
Passive Aging	+70°C, 1000 hours ±10% typical resistance change
Humidity Aging	+85°C, 85% R.H. 70days ±5% typical resistance change
Thermal Shock	MIL-STD-202 Method 107G +85°C/-40°C 20 times -30% typical resistance change
Vibration	MIL-STD-883C, Method 2007.1, Condition A No change

Dimensions

Figure 1

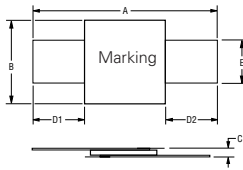

Figure 2

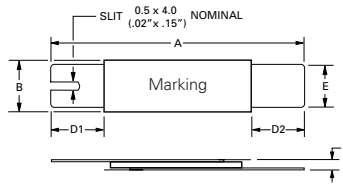

Figure 3

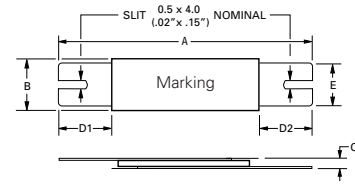

Figure 4

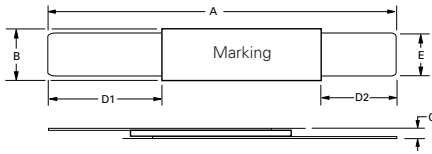

Figure 5

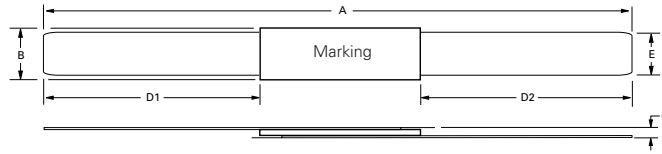
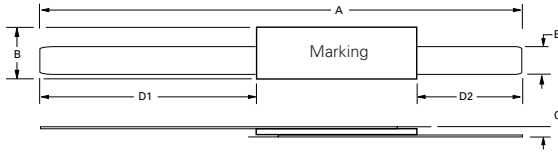
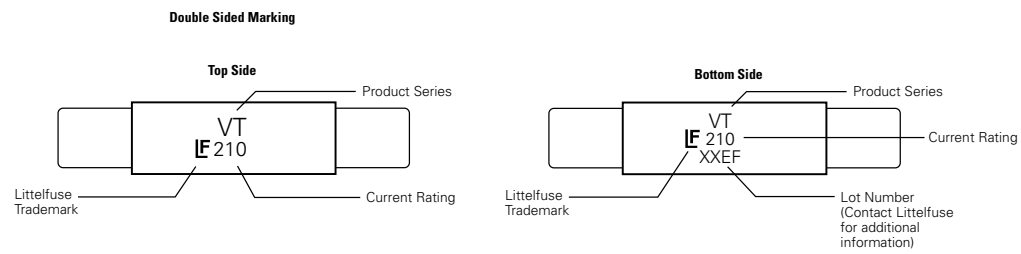

Figure 6



Part Number	A				B				C				D1		D2				E				Figure		
	Inches		mm		Inches		mm		Inches		mm		Inches		mm		Inches		mm		Inches			mm	
	Min.	Max.	Min.	Max.	Min.	Max.	Min.	Max.	Min.	Max.	Min.	Max.	Min.	Max.	Min.	Max.	Min.	Max.	Min.	Max.	Min.	Max.		Min.	Max.
16VT170	0.61	0.69	15.40	17.50	0.28	0.29	7.00	7.40	0.02	0.03	0.50	0.80	0.16	-	4.00	-	0.16	-	4.00	-	0.15	0.16	3.90	4.10	1
16VT170XS	0.82	0.90	20.90	22.90	0.19	0.21	4.90	5.30	0.02	0.03	0.50	0.80	0.16	-	4.00	-	0.16	-	4.00	-	0.15	0.16	3.90	4.10	2
16VT175	0.82	0.87	20.90	22.20	0.14	0.15	3.50	3.80	0.02	0.03	0.50	0.70	0.16	-	4.00	-	0.16	-	4.00	-	0.11	0.12	2.90	3.10	1
16VT175S	0.82	0.87	20.90	22.20	0.14	0.15	3.50	3.80	0.02	0.03	0.50	0.70	0.16	-	4.00	-	0.16	-	4.00	-	0.11	0.12	2.90	3.10	2
16VT175L	1.02	1.10	26.00	28.00	0.14	0.15	3.50	3.80	0.02	0.03	0.50	0.80	0.24	-	6.00	-	0.24	-	6.00	-	0.11	0.12	2.90	3.10	1
16VT175XL	1.00	1.11	25.50	28.20	0.14	0.15	3.50	3.90	0.02	0.03	0.50	0.80	0.34	0.41	8.70	10.30	0.22	0.29	5.70	7.30	0.09	0.10	2.40	2.60	4
16VT175EL	1.53	1.62	38.80	41.20	0.14	0.15	3.50	3.90	0.02	0.03	0.60	0.80	0.74	0.80	18.70	20.30	0.34	0.41	8.70	10.30	0.09	0.10	2.40	2.60	6
16VT175NEL	1.53	1.62	38.80	41.20	0.11	0.13	2.90	3.30	0.02	0.03	0.60	0.80	0.79	0.87	20.00	22.00	0.20	0.27	5.20	6.80	0.09	0.10	2.40	2.60	6
16VT200	0.82	0.91	20.90	23.10	0.15	0.17	3.80	4.30	0.02	0.03	0.60	0.70	0.16	-	4.00	-	0.16	-	4.00	-	0.11	0.12	2.90	3.10	1
16VT200S	0.82	0.91	20.90	23.10	0.15	0.17	3.80	4.30	0.02	0.03	0.60	0.70	0.16	-	4.00	-	0.16	-	4.00	-	0.11	0.12	2.90	3.10	2
16VT200UL	1.42	1.54	36.00	39.00	0.16	0.17	4.10	4.30	0.02	0.03	0.50	0.80	0.15	0.21	3.90	5.30	0.78	0.85	19.70	21.50	0.11	0.12	2.90	3.10	4
16VT210	0.82	0.91	20.90	23.10	0.19	0.21	4.90	5.30	0.02	0.03	0.60	0.80	0.16	-	4.10	-	0.16	-	4.10	-	0.15	0.16	3.90	4.10	1
16VT210S	0.82	0.91	20.90	23.10	0.19	0.21	4.90	5.30	0.02	0.03	0.60	0.80	0.16	0.23	4.10	5.80	0.16	0.23	4.10	5.80	0.15	0.16	3.90	4.10	2
16VT210SS	0.82	0.91	20.90	23.10	0.19	0.21	4.90	5.30	0.02	0.03	0.60	0.80	0.16	-	4.10	-	0.16	-	4.10	-	0.15	0.16	3.90	4.10	3
16VT210L	0.94	1.02	24.00	26.00	0.19	0.21	4.90	5.30	0.02	0.03	0.60	0.80	0.20	-	5.00	-	0.20	-	5.00	-	0.15	0.16	3.90	4.10	1
16VT210NL	2.78	2.81	70.50	71.50	0.15	0.17	3.80	4.30	0.02	0.03	0.60	0.80	0.98	-	25.00	-	0.98	-	25.00	-	0.11	0.12	2.90	3.10	5
16VT210UL	2.78	2.81	70.50	71.50	0.19	0.21	4.90	5.30	0.02	0.03	0.60	0.80	1.12	-	28.50	-	1.12	-	28.50	-	0.15	0.16	3.90	4.10	5
16VT240	0.95	1.03	24.20	26.20	0.19	0.21	4.90	5.30	0.02	0.03	0.60	0.80	0.20	-	5.00	-	0.20	-	5.00	-	0.15	0.16	3.90	4.10	1

Part Marking System



Part Numbering System

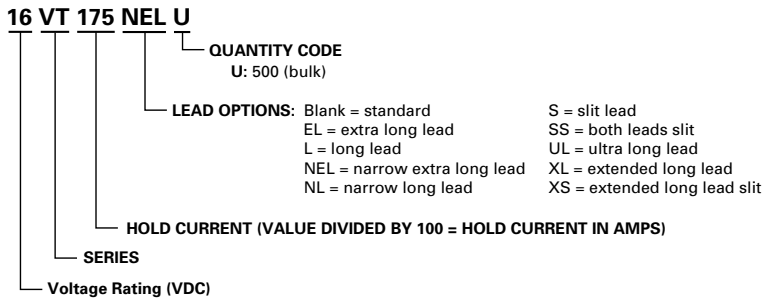

Packaging

I_{hold} (A)	Packaging Option	Quantity	Quantity & Packaging Codes
All Ratings	Bulk	500	U

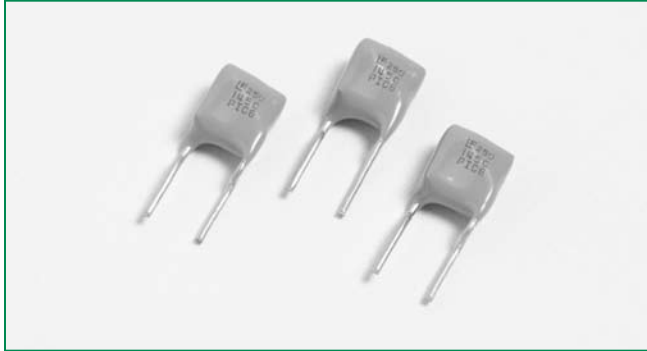

Description

- The 250R series is designed to protect against short duration high voltage fault currents (power cross or power induction surge) typically found in telecom applications (250Vrms). The series can be used to help telecom networking equipment meet the protection requirements specified in ITU K.20 and K.21.

Features

- RoHS compliant and lead-free
- Fast time-to-trip
- Binned and sorted narrow resistance ranges available
- 0.08 – 0.18 Hold current range, 60VDC operating voltage
- 250VAC interrupt rating

Agency Approvals

AGENCY	AGENCY FILE NUMBER
	E183209
	R50082521

Applications

- Customer Premises Equipment (CPE)
- Central Office (CO)/Telecom Centers
- LAN/WAN Equipment
- Access equipment

Electrical Characteristics

Part Number	I _{hold} (A)	I _{trip} (A)	V _{max} / V _{int} / V _{op}	I _{max} (A)	P _d max. (W)	Maximum Time To Trip		Resistance			Agency Approvals	
						Current (A)	Time (Sec.)	R _{min} (Ω)	R _{typ} (Ω)	R _{1max} (Ω)		
250R080T	0.08	0.16	250/60	3	1	0.35	3	15	22	33	X	X
250R080	0.08	0.16	250/60	3	1	0.35	3	14	22	33	X	X
250R120	0.12	0.24	250/60	3	1	1	1.5	4	8	16	X	X
250R120-RA	0.12	0.24	250/60	3	1	1	1.0	7	9	16	X	X
250R120-RC	0.12	0.24	250/60	3	1	1	0.85	5.4	7.5	14	X	X
250R120-RF	0.12	0.24	250/60	3	1	1	0.7	6	10.5	16	X	X
250R120-R1	0.12	0.24	250/60	3	1	1	0.8	6	9	16	X	X
250R120-R2	0.12	0.24	250/60	3	1	1	0.7	8	10.5	16	X	X
250R120-R3	0.12	0.24	250/60	3	1	1	1	8	10	16	X	X
250R120T	0.12	0.24	250/60	3	1	1	1.2	7	12	16	X	X
250R145	0.145	0.29	250/60	3	1	1	2.5	3	6	14	X	X
250R145-RA	0.145	0.29	250/60	3	1	1	5	3	5.5	12	X	X
250R145-RB	0.145	0.29	250/60	3	1	1	2.5	4.5	6	14	X	X
250R145T	0.145	0.29	250/60	3	1	1	2.0	5.4	7.5	14	X	X
250R180	0.18	0.65	250/60	10	1.8	1	21	0.8	2.2	4	X	X
250R180T	0.18	0.65	250/60	10	1.8	1	20	1.4	3.9	4.5	X	X

*typical value C: coated device T: pre-tripped device

Temperature Derating

Part Number	Ambient Operation Temperature								
	-40°C	-20°C	0°C	23°C	40°C	50°C	60°C	70°C	85°C
250R080	0.12	0.11	0.09	0.08	0.06	0.05	0.05	0.04	0.03
250R080T	0.12	0.11	0.09	0.08	0.06	0.05	0.05	0.04	0.03
250R120	0.18	0.16	0.14	0.12	0.10	0.09	0.08	0.06	0.05
250R120T	0.18	0.16	0.14	0.12	0.10	0.09	0.08	0.06	0.05
250R145	0.26	0.20	0.17	0.145	0.12	0.11	0.09	0.08	0.06
250R145T	0.26	0.20	0.17	0.145	0.12	0.11	0.09	0.08	0.06
250R180	0.28	0.23	0.21	0.18	0.16	0.13	0.10	0.11	0.083
250R180T	0.28	0.23	0.21	0.18	0.16	0.13	0.10	0.11	0.083

Average Time Current Curves

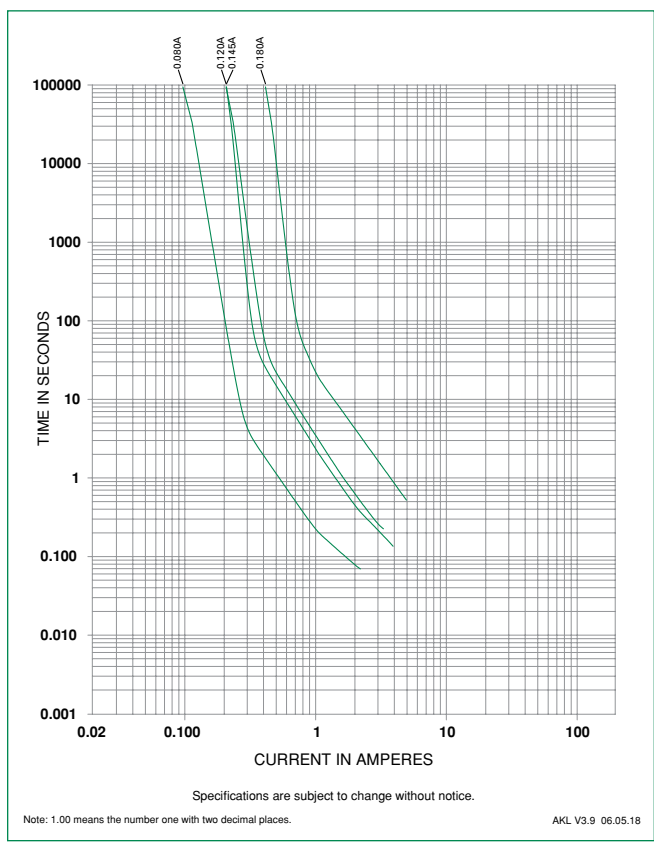

Temperature Derating Curve

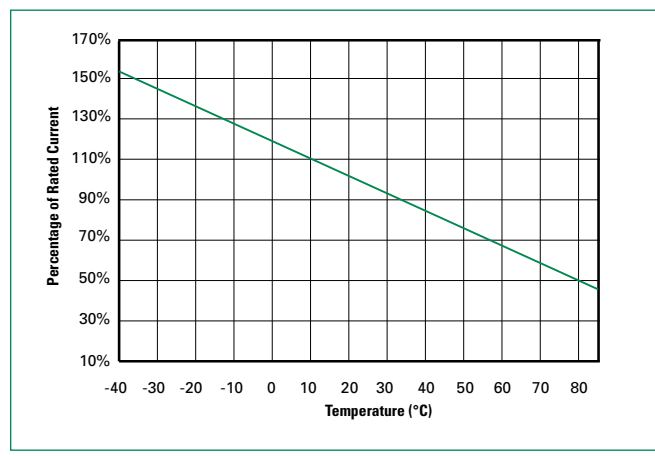

The average time current curves and temperature derating curve performance is affected by a number of variables, and these curves provided as guidance only. Customer must verify the performance in their application.

Agency Specification Selection Guide For Telecom and Networking Applications

Product	Lightning	Power Cross
250R120	ITU K.20/21/45 – 1.5kV 10/700µs	ITU K.20/21/45 – 230Vac, 10Ω
250R145	ITU K.20/21/45 – 4kV 10/700µs*	ITU K.20/21/45 – 600Vac, 600Ω
250R180	ITU K.20/21/45 – 1.5kV 10/700µs ITU K.20/21/45 – 4kV 10/700µs* Telcordia GR – 974 – 1.0kV 10/1000µs	ITU K.20/21/45 – 230Vac, 10Ω ITU K.20/21/45 – 600Vac, 600Ω Telcordia GR – 974- 283Vac, 10A

*Devices should be independently evaluated and tested for use in any specific application

Protection Application Guide

Region/Specification	Application	Device Selection
South America/Asia/Europe ITU K.45	*Access network equipment Remote terminal Repeaters WAN equipment Cross –connect	250R180 250R180T 250R145 250R145T 250R120 250R120T
South America/Asia/Europe ITU K.21	Customer and IT equipment Analog modems ADSL, xDSL Phone sets, PBX systems Internet appliances POS terminals	250R180 250R180T 250R145 250R145T 250R120 250R120T
South America/Asia/Europe ITU K.20	Central Office POTS/ISDN linecards T1/E1/J1 linecards ADSL/VDSL splitters CSU/DSU	250R180 250R180T 250R145 250R145T 250R120 250R120T
North America Telcordia GR-974	*Primary protection modules MDF modules Network interface	250R180 250R180T 250R145
South America/Asia/Europe ITU K.20		250R145T 250R120 250R120T
North America Telcordia GR-1089	*Intrabuilding communication systems LAN, VOIP cards Local loop handsets	250R180 250R180T 250R145
South America/Asia/Europe ITU K.20 and K.21		250R145T 250R120 250R120T
	LAN Intrabuilding power cross Protection LAN equipment, IP phone	250R080

*Resistance binned parts are recommended

Soldering Parameters - Wave Soldering

Condition	Wave Soldering
Peak Temp/ Duration Time	260°C ≤ 5 Sec
≥ 220°C	2 Sec ~ 20 Sec
Preheat 140°C ~ 180°C	180 Sec ~ 210 Sec
Storage Condition	0°C~35°C ≤ 70%RH

- Recommended soldering methods: heat element oven or N₂ environment for lead-free.
- Devices are designed to be wave soldered to the bottom side of the board.
- Devices can be cleaned using standard industry methods and solvents.
- This profile can be used for lead-free device

Note: If soldering temperatures exceed the recommended profile, devices may not meet the performance requirements.

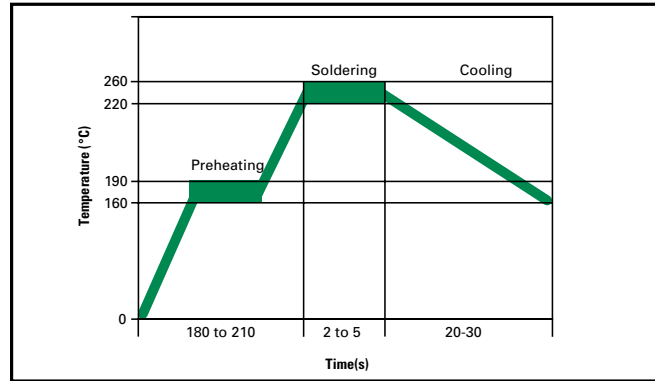

Soldering Parameters - Solder Reflow

Condition	Reflow
Peak Temp/ Duration Time	260°C ≥ 5 Sec
≥ 220°C	30 Sec ~ 60 Sec
Preheat 160°C ~ 190°C	60 Sec ~ 90 Sec
Storage Condition	0°C~35°C, ≤ 70%RH

- Recommended reflow methods: IR, vapor phase oven, hot air oven, N₂ environment for lead-free.
- Devices are not designed to be wave soldered to the bottom side of the board.
- Devices can be cleaned using standard industry methods and solvents.

Note: If reflow temperatures exceed the recommended profile, devices may not meet the performance requirements.

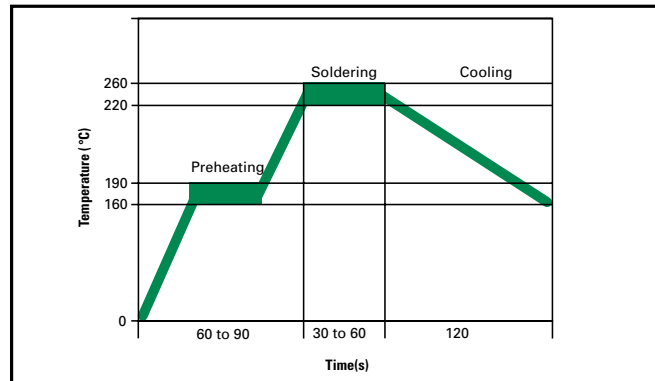

Physical Specifications

Lead Material	Tin-plated copper
Soldering Characteristics	Solderability per MIL-STD-202, Method 208E
Insulating Material	Cured, flame retardant epoxy polymer meets UL94V-0 requirements.
Device Labeling	Marked with LF, voltage, current rating, and date code.

Environmental Specifications

Operating/Storage Temperature	-40°C to +85°C
Maximum Device Surface Temperature in Tripped State	125°C
Passive Aging	65°C/85°C, 1000 hours
Humidity Aging	+85°C, 85%R.H. 1000 hours
Thermal Shock	MIL-STD-202F Method 107G +125°C to -55°C 10 times
Solvent Resistance	MIL-STD-202, Method 215F

Dimensions

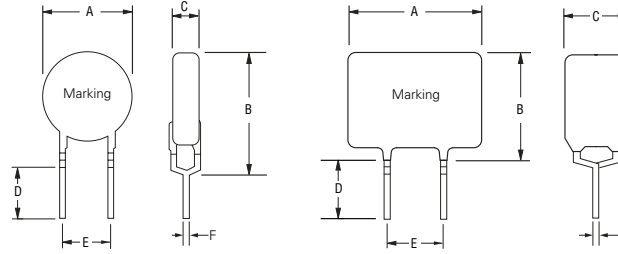

Figure 1

Figure 2

Part Number	A		B		C		D		E		Physical Characteristics			
	Inches	mm	Inches	mm	Inches	mm	Inches	mm	Inches	mm	Lead (dia)		Material	Figure
	Max.	Max.	Max.	Max.	Max.	Max.	Min.	Min.	Typ.	Typ.	Inches	mm		
250R080	0.23	5.8	0.39	9.9	0.18	4.6	0.19	4.7	0.20	5.1	0.026	0.65	Sn/Cu	1
250R080T	0.23	5.8	0.39	9.9	0.18	4.6	0.19	4.7	0.20	5.1	0.026	0.65	Sn/Cu	1
250R120	0.26	6.5	0.43	11	0.15	3.8	0.19	4.7	0.20	5.1	0.026	0.65	Sn/Cu	2
250R120-RA	0.26	6.5	0.43	11	0.18	4.6	0.19	4.7	0.20	5.1	0.026	0.65	Sn/Cu	2
250R120-RC	0.26	6.5	0.43	11	0.18	4.6	0.19	4.7	0.20	5.1	0.026	0.65	Sn/Cu	2
250R120-RF	0.26	6.5	0.43	11	0.18	4.6	0.19	4.7	0.20	5.1	0.026	0.65	Sn/Cu	2
250R120-R1	0.26	6.5	0.43	11	0.18	4.6	0.19	4.7	0.20	5.1	0.026	0.65	Sn/Cu	2
250R120-R2	0.26	6.5	0.43	11	0.18	4.6	0.19	4.7	0.20	5.1	0.026	0.65	Sn/Cu	2
250R120-R3	0.26	6.5	0.43	11	0.18	4.6	0.19	4.7	0.20	5.1	0.026	0.65	Sn/Cu	2
250R120T	0.26	6.5	0.43	11	0.18	4.6	0.19	4.7	0.20	5.1	0.026	0.65	Sn/Cu	2
250R145	0.26	6.5	0.43	11	0.18	4.6	0.19	4.7	0.20	5.1	0.026	0.65	Sn/Cu	2
250R145-RA	0.26	6.5	0.43	11	0.18	4.6	0.19	4.7	0.20	5.1	0.026	0.65	Sn/Cu	2
250R145-RB	0.26	6.5	0.43	11	0.18	4.6	0.19	4.7	0.20	5.1	0.026	0.65	Sn/Cu	2
250R145T	0.26	6.5	0.43	11	0.18	4.6	0.19	4.7	0.20	5.1	0.026	0.65	Sn/Cu	2
250R180	0.37	9.5	0.47	12	0.18	4.6	0.19	4.7	0.20	5.1	0.026	0.65	Sn/Cu	1
250F180T	0.37	9.5	0.47	12	0.18	4.6	0.19	4.7	0.20	5.1	0.026	0.65	Sn/Cu	1

Part Marking System



Part Numbering System

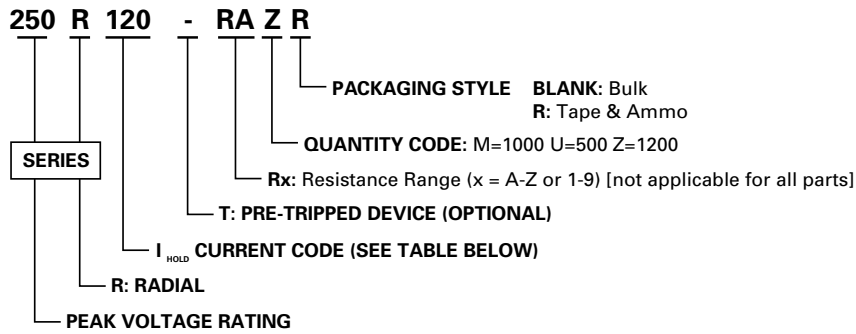

Packaging

I _{hold} (A)	I _{hold} Code	Packaging Option	Quantity	Quantity & Packaging Codes
0.080	080	Bulk	500	U
		Tape and Ammo	1500	DR
0.120	120	Bulk	500	U
		Tape and Ammo	1200	ZR
0.145	145	Bulk	500	U
		Tape and Ammo	1200	ZR
0.180	180	Bulk	200	F
		Tape and Ammo	1000	MR

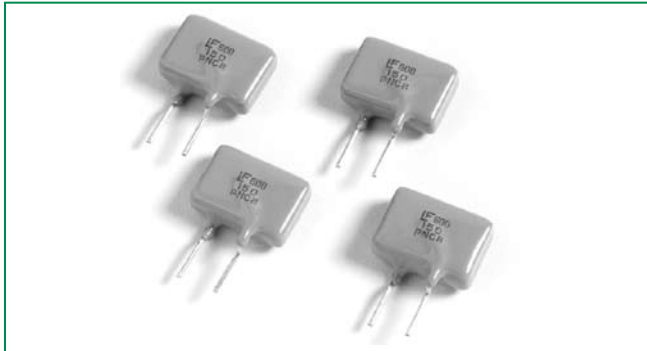

Description

• The 600R series is designed to protect against power fault events typically found in telecom applications. This series is designed to be used in applications that need to meet the requirements of GR-1089-CORE and UL60950/EN60950/IEC60950. These resettable devices also help to meet the requirements of ITU K.20, K.21 and K.44.

Features

- RoHS compliant and lead-free
- Fast time-to-trip
- Binned and sorted narrow resistance ranges available
- 0.15 – 0.16A Hold current range, 60VDC operating voltage
- 600VAC interrupt rating

Agency Approvals

AGENCY	AGENCY FILE NUMBER
	E183209
	R50082521

Applications

- Secondary overcurrent protection for:
- Central Office Equipment (CO)
 - Customer Premises Equipment (CE)
 - Alarm Systems
 - Set Top Boxes (STB)
 - Voice over IP (VOIP)
 - Subscriber Line Interface Circuit (SLIC)

Electrical Characteristics

Part Number	I _{hold} (A)	I _{trip} (A)	V _{max} (Vdc)	I _{max} (A)	P _{d max.} (W)	Maximum Time To Trip		Resistance			Agency Approvals	
						Current (A)	Time (Sec.)	R _{min} (Ω)	R _{typ} (Ω)	R _{1max} (Ω)		
600R150	0.15	0.30	600	3	1.00	5.0	8.0	6	12	22	X	X
600R150-RA	0.15	0.30	600	3	1.00	5.0	7.5	7	10	20	X	X
600R150-RB	0.15	0.30	600	3	1.00	4.5	-	9	12	22	X	X
600R160	0.16	0.32	600	3	1.00	7.5	18	4	10	18	X	X
600R160-RA	0.16	0.32	600	3	1.00	9.5	-	4	7	16	X	X
600R160-R1	0.16	0.32	600	3	1.00	9.0	-	4	8	17	X	X

Temperature Derating

Part Number	Ambient Operation Temperature						
	-40°C	-20°C	0°C	23°C	40°C	60°C	85°C
	Hold Current (A)						
600R150	0.26	0.23	0.19	0.15	0.124	0.062	0.03
600R160	0.27	0.24	0.20	0.16	0.13	0.07	0.05

Average Time Current Curves

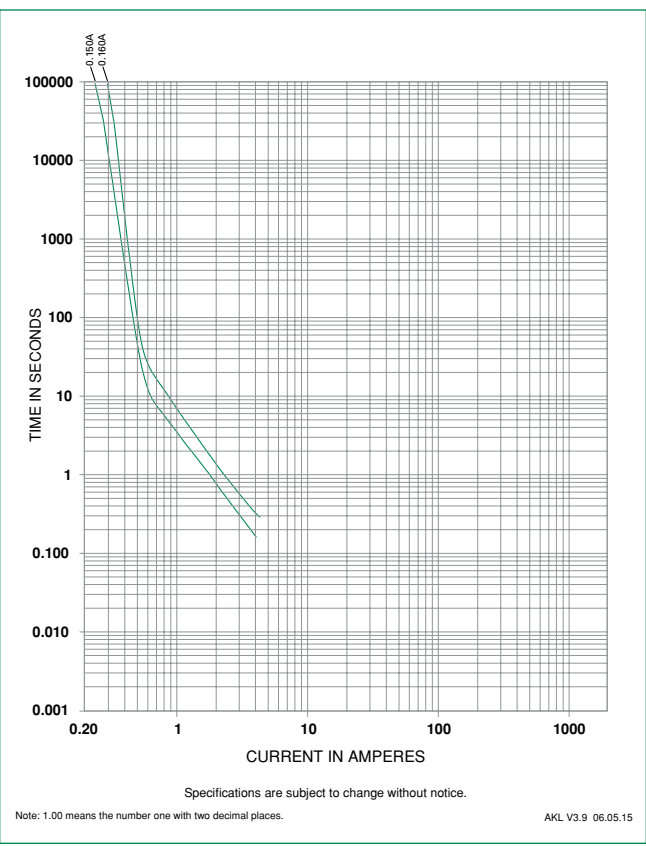

Temperature Rerating Curve

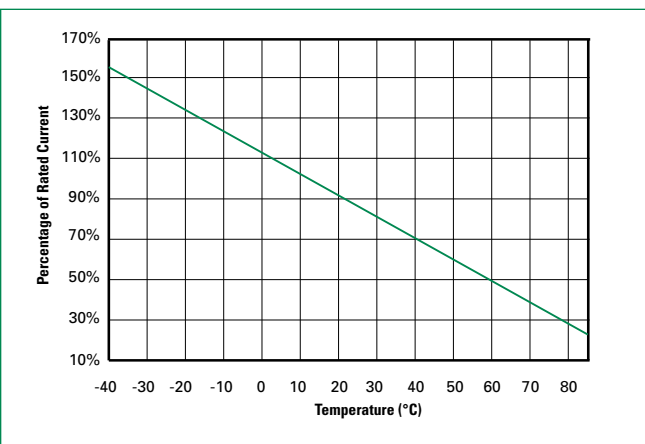

The average time current curves and temperature rerating curve performance is affected by a number of variables, and these curves provided as guidance only. Customer must verify the performance in their application.

Agency Specification Selection Guide For Telecom and Networking Applications

Part Number	Lightning	Power Cross
600R150 600R160	TIA-968-A – 1.5kV 10/160µs 800V 10/560µs Telcordia GR –1089–1.0kV 10/1000µs 2.5kV 2/10µs	UL60950, 3rd Ed – 600Vac, 40A Telcordia GR – 1089 – 600Vac, 60A

Devices should be independently evaluated and tested for use in any specific application

Protection Application Guide

Region/Specification	Application	Device Selection
North America Telcordia GR-1089	*Access network equipment Remote terminal Repeaters WAN equipment Cross-connect	600R150 600R160
North America TIA-968-A, UL60950	Customer and IT equipment Analog modems ADSL, XDSL modems Phone sets, PBX systems Internet appliances POS terminals	600R150 600R160
North America Telcordia GR-1089	Central Office POTS/ISDN linecards T1/E1/J1 linecards ADSL/VDSL splitters CSU/DSU	600R150 600R160
North America Telcordia GR-1089 South America/Asia/Europe ITU K.20 and K.21	*Intrabuilding communication systems LAN, VOIP cards Local loop handsets	600R150 600R160

*Resistance binned parts are recommended

Soldering Parameters - Wave Soldering

Condition	Wave Soldering
Peak Temp/ Duration Time	260°C ≤ 5 Sec
≥ 220°C	2 Sec ~ 20 Sec
Preheat 140°C~ 180°C	180 Sec ~ 210 Sec
Storage Condition	0°C~35°C, ≤ 70%RH

- Recommended soldering methods: heat element oven or N₂ environment for lead-free
- Devices are designed to be wave soldered to the bottom side of the board.
- Devices can be cleaned using standard industry methods and solvents.
- This profile can be used for lead-free device

Note: If soldering temperatures exceed the recommended profile, devices may not meet the performance requirements.

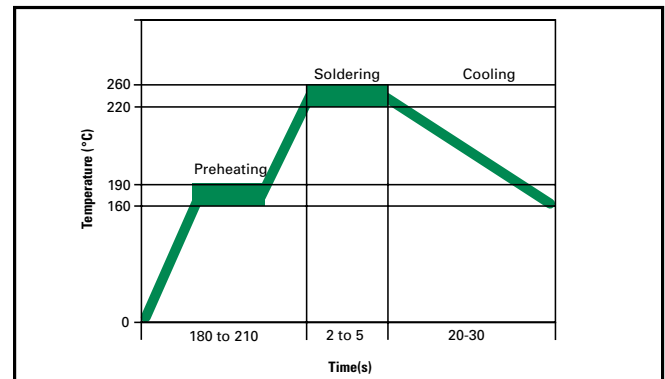

Soldering Parameters - Solder Reflow

Condition	Reflow
Peak Temp/ Duration Time	260°C ≥ 5 Sec
≥ 220°C	30 Sec ~ 60 Sec
Preheat 160°C~ 190°C	60 Sec ~ 90 Sec
Storage Condition	0°C~35°C, ≤ 70%RH

- Recommended reflow methods: IR, vapor phase oven, hot air oven, N₂ environment for lead-free.
- Devices are not designed to be wave soldered to the bottom side of the board.
- Devices can be cleaned using standard industry methods and solvents.

Note: If reflow temperatures exceed the recommended profile, devices may not meet the performance requirements.

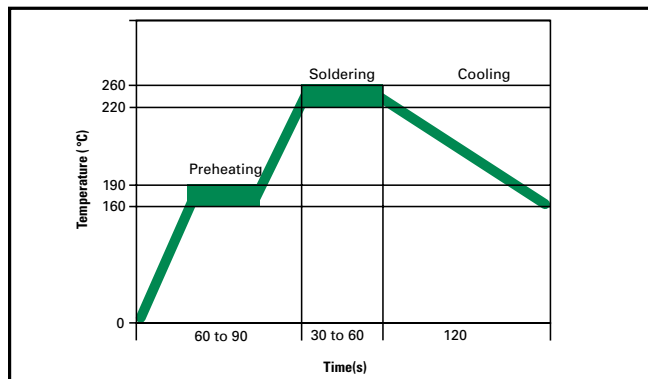

Physical Specifications

Lead Material	Tin-plated copper
Soldering Characteristics	Solderability per MIL-STD-202, Method 208E
Insulating Material	Cured, flame retardant epoxy polymer meets UL94V-0 requirements.
Device Labeling	Marked with LF, voltage, current rating, and date code.

Environmental Specifications

Operating/Storage Temperature	-40°C to +85°C
Maximum Device Surface Temperature in Tripped State	125°C
Passive Aging	85°C/85°C, 1000 hours
Humidity Aging	+85°C, 85%R.H. 1000 hours
Thermal Shock	MIL-STD-202F Method 107G +125°C to -55°C 10 times
Solvent Resistance	MIL-STD-202, Method 215F

Dimensions

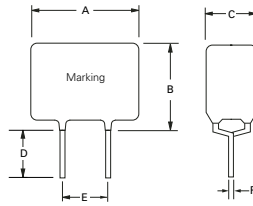
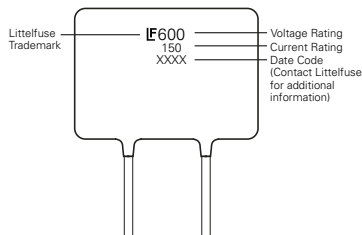

Figure 1

Part Number	A		B		C		D		E		Physical Characteristics			
	Inches	mm	Inches	mm	Inches	mm	Inches	mm	Inches	mm	Lead (dia)		Material	Figure
	Max.	Max.	Max.	Max.	Max.	Max.	Min.	Min.	Typ.	Typ.	Inches	mm		
600R150	0.53	13.5	0.50	12.6	0.24	6	0.19	4.7	0.20	5.1	0.026	0.65	Sn/Cu	1
600R150-RA	0.53	13.5	0.50	12.6	0.24	6	0.19	4.7	0.20	5.1	0.026	0.65	Sn/Cu	1
600R150-RB	0.53	13.5	0.50	12.6	0.24	6	0.19	4.7	0.20	5.1	0.026	0.65	Sn/Cu	1
600R160	0.63	16	0.50	12.6	0.24	6	0.19	4.7	0.20	5.1	0.026	0.65	Sn/Cu	1
600R160-RA	0.63	16	0.50	12.6	0.24	6	0.19	4.7	0.20	5.1	0.026	0.65	Sn/Cu	1
600R160-R1	0.63	16	0.50	12.6	0.24	6	0.19	4.7	0.20	5.1	0.026	0.65	Sn/Cu	1

Part Marking System



Part Numbering System

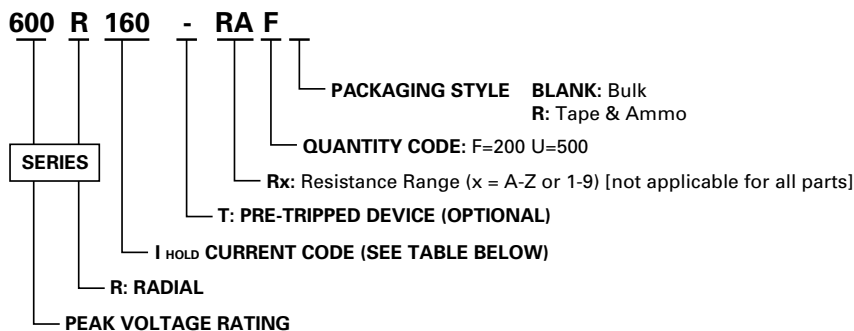

Packaging

I_{hold} (A)	I_{hold} Code	Packaging Option	Quantity	Quantity & Packaging Codes
0.15	150	Bulk	200	F
		Tape and Ammo	600	ZR
0.16	160	Bulk	200	F
		Tape and Ammo	500	UR

RoHS **30R Series**



Description

- The 30R series radial leaded device is designed to provide overcurrent protection for low voltage ($\leq 30V$) applications where space is not a concern and resettable protection is preferred.

Features

- RoHS compliant and lead-free
- Fast time-to-trip
- Cured, flame retardant epoxy polymer insulating material meets UL 94V-0 requirements

Agency Approvals

AGENCY	AGENCY FILE NUMBER
	E183209
	R50082521

Applications

- USB hubs, ports and peripherals
- Computers & peripherals
- Motor protection
- General electronics
- Automotive applications

Electrical Characteristics

Part Number	I_{hold} (A)	I_{trip} (A)	V_{max} (Vdc)	I_{max} (A)	P_d max. (W)	Maximum Time To Trip		Resistance		Agency Approvals	
						Current (A)	Time (Sec.)	R_{min} (Ω)	R_{1max} (Ω)		
30R090	0.90	1.80	30	40	0.6	4.50	5.90	0.070	0.220	X	X
30R110	1.10	2.20	30	40	0.7	5.50	6.60	0.050	0.170	X	X
30R135	1.35	2.70	30	40	0.8	6.75	7.30	0.040	0.130	X	X
30R160	1.60	3.20	30	40	0.9	8.00	8.00	0.030	0.110	X	X
30R185	1.85	3.70	30	40	1.0	9.25	8.70	0.030	0.090	X	X
30R250	2.50	5.00	30	40	1.2	12.50	10.30	0.020	0.070	X	X
30R300	3.00	6.00	30	40	2.0	15.00	10.80	0.020	0.080	X	X
30R400	4.00	8.00	30	40	2.5	20.00	12.70	0.010	0.050	X	X
30R500	5.00	10.00	30	40	3.0	25.00	14.50	0.010	0.050	X	X
30R600	6.00	12.00	30	40	3.5	30.00	16.00	0.005	0.040	X	X
30R700	7.00	14.00	30	40	3.8	35.00	17.50	0.005	0.030	X	X
30R800	8.00	16.00	30	40	4.0	40.00	18.80	0.005	0.020	X	X
30R900	9.00	18.00	30	40	4.2	40.00	20.00	0.005	0.020	X	X

I_{hold} = Hold current: maximum current device will pass without tripping in 23°C still air.
 I_{trip} = Trip current: minimum current at which the device will trip in 23°C still air.
 V_{max} = Maximum voltage device can withstand without damage at rated current (I_{max})
 I_{max} = Maximum fault current device can withstand without damage at rated voltage (V_{max})
 P_d = Power dissipated from device when in the tripped state at 23°C still air.

R_{min} = Minimum resistance of device in initial (un-soldered) state.
 R_{1max} = Maximum resistance of device at 23°C measured one hour after tripping.
Caution: Operation beyond the specified rating may result in damage and possible arcing and flame.

Temperature Derating

Part Number	Ambient Operation Temperature								
	-40°C	-20°C	0°C	23°C	40°C	50°C	60°C	70°C	85°C
30R090	1.31	1.17	1.04	0.90	0.75	0.69	0.61	0.55	0.47
30R110	1.60	1.43	1.27	1.10	0.91	0.85	0.75	0.67	0.57
30R135	1.96	1.76	1.55	1.35	1.12	1.04	0.92	0.82	0.70
30R160	2.32	2.08	1.84	1.60	1.33	1.23	1.09	0.98	0.83
30R185	2.68	2.41	2.13	1.85	1.54	1.42	1.26	1.13	0.96
30R250	3.63	3.25	2.88	2.50	2.08	1.93	1.70	1.53	1.30
30R300	4.35	3.90	3.45	3.00	2.49	2.31	2.04	1.83	1.56
30R400	5.80	5.20	4.60	4.00	3.32	3.08	2.72	2.44	2.08
30R500	7.25	6.50	5.75	5.00	4.15	3.85	3.40	3.05	2.60
30R600	8.70	7.80	6.90	6.00	4.98	4.62	4.08	3.66	3.12
30R700	10.15	9.10	8.05	7.00	5.81	5.39	4.76	4.27	3.64
30R800	11.60	10.40	9.20	8.00	6.64	6.16	5.44	4.88	4.16
30R900	13.05	11.70	10.35	9.00	7.47	6.93	6.12	5.49	4.68

Average Time Current Curves

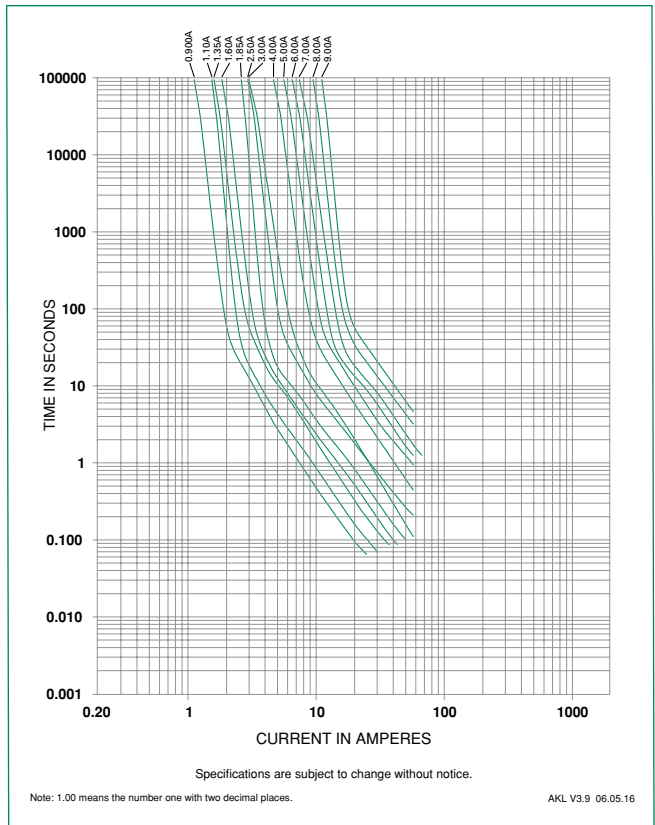

Temperature Derating Curve

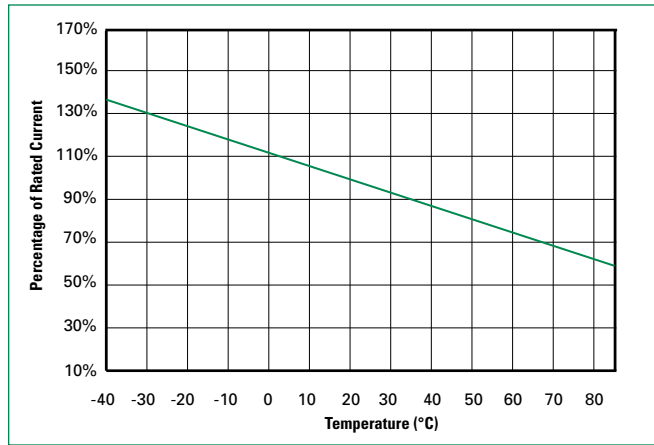

The average time current curves and temperature derating curve performance is affected by a number of variables, and these curves provided as guidance only. Customer must verify the performance in their application.

Soldering Parameters - Wave Soldering

Pre-Heating Zone	Refer to the condition recommended by the flux manufacturer. Max. ramping rate should not exceed 4°C/Sec.
Soldering Zone	Max. solder temperature should not exceed 260°C
Cooling Zone	Cooling by natural convection in air.

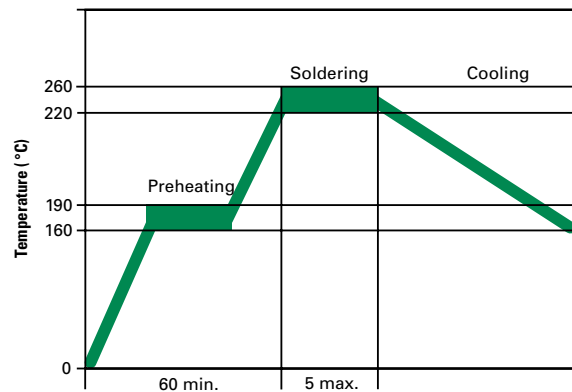

Physical Specifications

Lead Material	0.90-2.50A: Tin-plated copper clad steel 3.00-9.00A: Tin-plated copper
Soldering Characteristics	Solderability per MIL-STD-202, Method 208E
Insulating Material	Cured, flame retardant epoxy polymer meets UL94V-0 requirements.
Device Labeling	Marked with LF, voltage, current rating, and date code.

Environmental Specifications

Operating/Storage Temperature	-40°C to +85°C
Maximum Device Surface Temperature in Tripped State	125°C
Passive Aging	+85°C, 1000 hours ±5% typical resistance change
Humidity Aging	+85°C, 85%R.H. 1000 hours ±5% typical resistance change
Thermal Shock	+85°C to -40°C 10 times ±5% typical resistance change
Solvent Resistance	MIL-STD-202, Method 215F No change

Dimensions

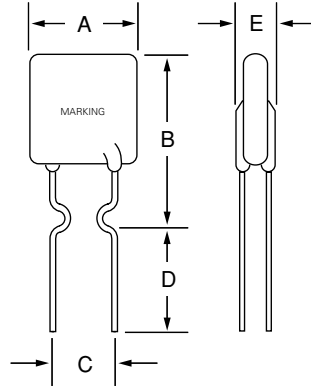

Part Number	A		B		C		D		E		Physical Characteristics		
	Inches	mm	Inches	mm	Inches	mm	Inches	mm	Inches	mm	Lead (dia)		Material
	Max.	Max.	Max.	Max.	Typ.	Typ.	Min.	Min.	Max.	Max.	Inches	mm	
30R090	0.29	7.40	0.48	12.20	0.20	5.10	0.30	7.60	0.12	3.00	0.02	0.51	Sn/CuFe
30R110	0.29	7.40	0.56	14.20	0.20	5.10	0.30	7.60	0.12	3.00	0.02	0.51	Sn/CuFe
30R135	0.35	8.90	0.53	13.50	0.20	5.10	0.30	7.60	0.12	3.00	0.02	0.51	Sn/CuFe
30R160	0.35	8.90	0.60	15.20	0.20	5.10	0.30	7.60	0.12	3.00	0.02	0.51	Sn/CuFe
30R185	0.40	10.20	0.62	15.70	0.20	5.10	0.30	7.60	0.12	3.00	0.02	0.51	Sn/CuFe
30R250	0.45	11.40	0.72	18.30	0.20	5.10	0.30	7.60	0.12	3.00	0.02	0.51	Sn/CuFe
30R300	0.45	11.40	0.76	19.20	0.20	5.10	0.30	7.60	0.12	3.00	0.02	0.51	Sn/Cu
30R400	0.55	14.00	0.87	22.00	0.20	5.10	0.30	7.60	0.12	3.00	0.03	0.81	Sn/Cu
30R500	0.55	14.00	1.01	25.60	0.40	10.20	0.30	7.60	0.12	3.00	0.03	0.81	Sn/Cu
30R600	0.65	16.50	1.06	26.80	0.40	10.20	0.30	7.60	0.12	3.00	0.03	0.81	Sn/Cu
30R700	0.75	19.10	1.13	28.60	0.40	10.20	0.30	7.60	0.12	3.00	0.03	0.81	Sn/Cu
30R800	0.85	21.60	1.22	31.10	0.40	10.20	0.30	7.60	0.12	3.00	0.03	0.81	Sn/Cu
30R900	0.95	24.10	1.24	31.60	0.40	10.20	0.30	7.60	0.12	3.00	0.03	0.81	Sn/Cu

Part Marking System

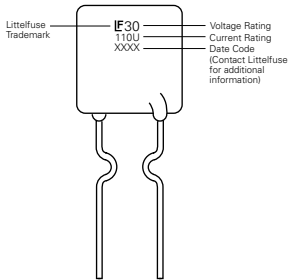

Part Numbering System

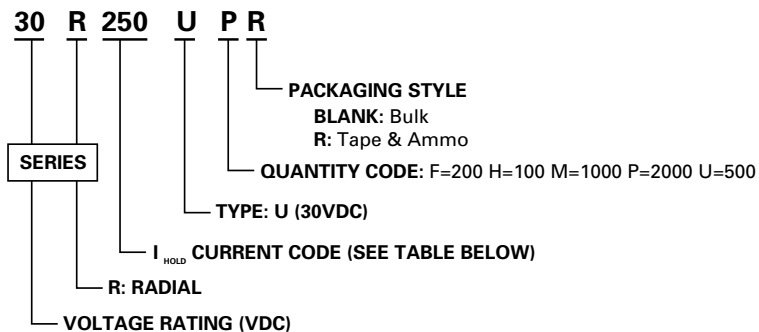

Packaging

I_{hold} (A)	I_{hold} Code	Packaging Option	Quantity	Quantity & Packaging Codes
0.90	090	Bulk	500	U
		Tape and Ammo	2000	PR
1.10	110	Bulk	500	U
		Tape and Ammo	2000	PR
1.35	135	Bulk	500	U
		Tape and Ammo	2000	PR
1.60	160	Bulk	500	U
		Tape and Ammo	2000	PR
1.85	185	Bulk	500	U
		Tape and Ammo	2000	PR
2.50	250	Bulk	500	U
		Tape and Ammo	2000	PR
3.00	300	Bulk	500	U
		Tape and Ammo	2000	PR
4.00	400	Bulk	200	F
		Tape and Ammo	1000	MR
5.00	500	Bulk	200	F
		Tape and Ammo	1000	MR
6.00	600	Bulk	200	F
		Tape and Ammo	1000	MR
7.00	700	Bulk	200	F
		Tape and Ammo	1000	MR
8.00	800	Bulk	100	H
9.00	900	Bulk	100	H



Description

- The 60R series radial leaded device is designed to provide overcurrent protection for ($\leq 60V$) applications where space is not a concern and resettable protection is preferred.

Features

- RoHS compliant and lead-free
- Fast time-to-trip
- Cured, flame retardant epoxy polymer insulating material meets UL 94V-0 requirements

Agency Approvals

AGENCY	AGENCY FILE NUMBER
	E183209
	R50082521

Applications

- USB hubs, ports and peripherals
- IEEE1394 ports
- Computers & peripherals
- Motor protection
- General electronics
- Automotive applications
- Industrial controls
- Transformers

Electrical Characteristics

Part Number	I_{hold} (A)	I_{trip} (A)	V_{max} (Vdc)	I_{max} (A)	P_d max. (W)	Maximum Time To Trip		Resistance		Agency Approvals	
						Current (A)	Time (Sec.)	R_{min} (Ω)	R_{1max} (Ω)		
60R010	0.10	0.20	60	40	0.38	0.50	4.00	2.500	7.500	X	X
60R020	0.20	0.40	60	40	0.41	1.00	2.20	1.830	4.400	X	X
60R025	0.25	0.50	60	40	0.45	1.25	2.50	1.250	3.000	X	X
60R030	0.30	0.60	60	40	0.49	1.50	3.00	0.880	2.100	X	X
60R040	0.40	0.80	60	40	0.56	2.00	3.80	0.550	1.290	X	X
60R050	0.50	1.00	60	40	0.77	2.50	4.00	0.500	1.170	X	X
60R065	0.65	1.30	60	40	0.88	3.25	5.30	0.310	0.720	X	X
60R075	0.75	1.50	60	40	0.92	3.75	6.30	0.250	0.600	X	X
60R090	0.90	1.80	60	40	0.99	4.50	7.20	0.200	0.470	X	X
60R110	1.10	2.20	60	40	1.50	5.50	8.20	0.150	0.380	X	X
60R135	1.35	2.70	60	40	1.70	6.75	9.60	0.120	0.300	X	X
60R160	1.60	3.20	60	40	1.90	8.00	11.40	0.090	0.220	X	X
60R185	1.85	3.70	60	40	2.10	9.25	12.60	0.080	0.190	X	X
60R250	2.50	5.00	60	40	2.50	12.50	15.60	0.050	0.130	X	X
60R300	3.00	6.00	60	40	2.80	15.00	19.80	0.040	0.100	X	X
60R375	3.75	7.50	60	40	3.20	18.75	24.00	0.030	0.080	X	X

I_{hold} = Hold current: maximum current device will pass without tripping in 20°C still air.

I_{trip} = Trip current: minimum current at which the device will trip in 20°C still air.

V_{max} = Maximum voltage device can withstand without damage at rated current (I_{max})

I_{max} = Maximum fault current device can withstand without damage at rated voltage (V_{max})

P_d = Power dissipated from device when in the tripped state at 20°C still air.

R_{min} = Minimum resistance of device in initial (un-soldered) state.

R_{typ} = Typical resistance of device in initial (un-soldered) state.

R_{1max} = Maximum resistance of device at 20°C measured one hour after tripping or reflow soldering of 260°C for 20 sec.

Caution: Operation beyond the specified rating may result in damage and possible arcing and flame.

Temperature Derating

Part Number	Ambient Operation Temperature								
	-40°C	-20°C	0°C	23°C	40°C	50°C	60°C	70°C	85°C
60R010	0.16	0.14	0.12	0.10	0.08	0.07	0.06	0.05	0.04
60R020	0.31	0.27	0.24	0.20	0.16	0.14	0.13	0.11	0.08
60R025	0.39	0.34	0.30	0.25	0.20	0.18	0.16	0.14	0.10
60R030	0.47	0.41	0.36	0.30	0.24	0.22	0.19	0.16	0.12
60R040	0.62	0.54	0.48	0.40	0.32	0.29	0.25	0.22	0.16
60R050	0.78	0.68	0.60	0.50	0.41	0.36	0.32	0.27	0.20
60R065	1.01	0.88	0.77	0.65	0.53	0.47	0.41	0.35	0.26
60R075	1.16	1.02	0.89	0.75	0.61	0.54	0.47	0.41	0.30
60R090	1.40	1.22	1.07	0.90	0.73	0.65	0.57	0.49	0.36
60R110	1.71	1.50	1.31	1.10	0.89	0.79	0.69	0.59	0.44
60R135	2.09	1.84	1.61	1.35	1.09	0.97	0.85	0.73	0.54
60R160	2.48	2.18	1.90	1.60	1.30	1.15	1.01	0.86	0.64
60R185	2.87	2.52	2.20	1.85	1.50	1.33	1.17	1.00	0.74
60R250	3.88	3.40	2.98	2.50	2.03	1.80	1.58	1.35	1.00
60R300	4.65	4.08	3.57	3.00	2.43	2.16	1.89	1.62	1.20
60R375	5.81	5.10	4.46	3.75	3.04	2.70	2.36	2.03	1.50

Average Time Current Curves

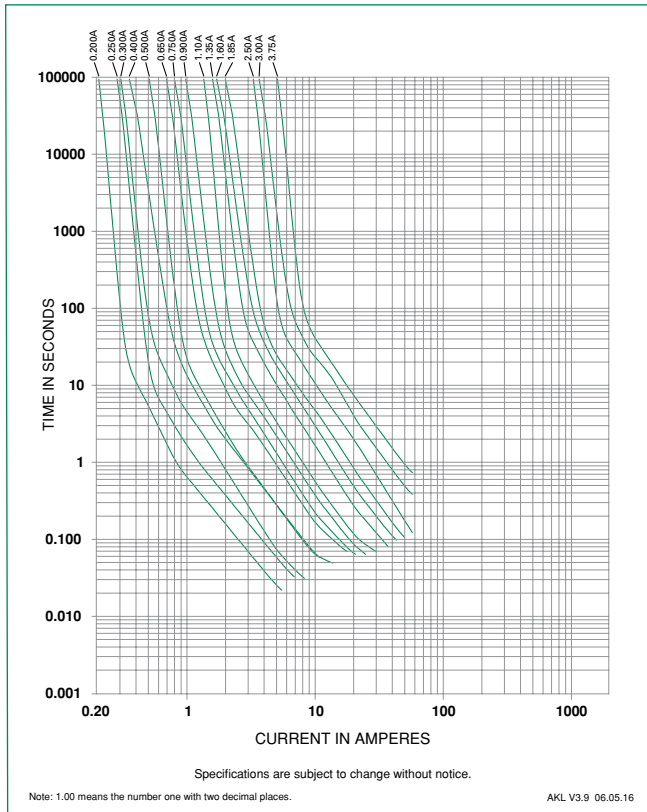

Temperature Derating Curve

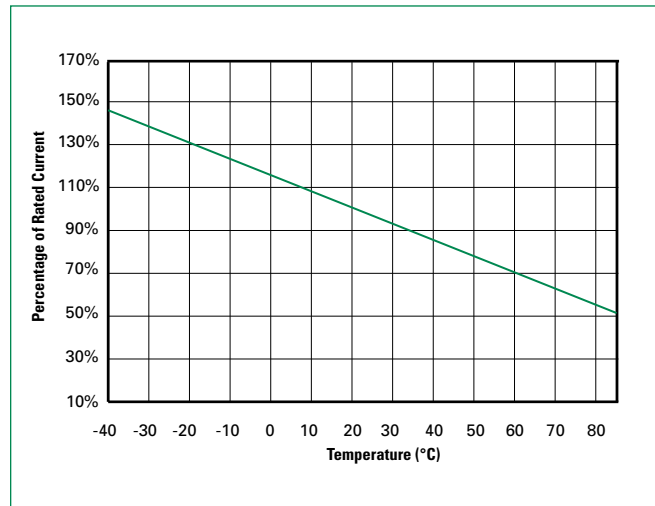

The average time current curves and temperature derating curve performance is affected by a number of variables, and these curves provided as guidance only. Customer must verify the performance in their application.

Soldering Parameters - Wave Soldering

Pre-Heating Zone	Refer to the condition recommended by the flux manufacturer. Max. ramping rate should not exceed 4°C/Sec.
Soldering Zone	Max. solder temperature should not exceed 260°C
Cooling Zone	Cooling by natural convection in air.

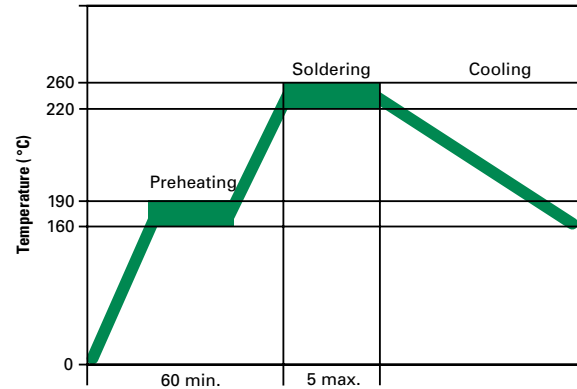

Physical Specifications

Lead Material	.20-.40A: Tin-plated copper clad steel .50-3.75A: Tin-plated copper
Soldering Characteristics	Solderability per MIL-STD-202, Method 208E
Insulating Material	Cured, flame retardant epoxy polymer meets UL94V-0 requirements.
Device Labeling	Marked with LF, voltage, current rating, and date code.

Environmental Specifications

Operating/Storage Temperature	-40°C to +85°C
Maximum Device Surface Temperature in Tripped State	125°C
Passive Aging	+85°C, 1000 hours ±5% typical resistance change
Humidity Aging	+85°C, 85%R.H. 1000 hours ±5% typical resistance change
Thermal Shock	+85°C to -40°C 10 times ±5% typical resistance change
Solvent Resistance	MIL-STD-202, Method 215F

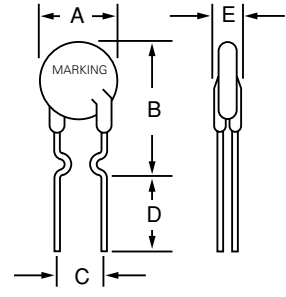
Dimensions



Part Number	A		B		C		D		E		Physical Characteristics		
	Inches	mm	Inches	mm	Inches	mm	Inches	mm	Inches	mm	Lead (dia)		Material
	Max.	Max.	Max.	Max.	Typ.	Typ.	Min.	Min.	Max.	Max.	Inches	mm	
60R010	0.29	7.4	0.50	12.7	0.20	5.1	0.30	7.6	0.12	3.1	0.02	0.51	Sn/CuFe
60R020	0.29	7.4	0.46	11.7	0.20	5.1	0.30	7.6	0.12	3.1	0.02	0.51	Sn/CuFe
60R025	0.29	7.4	0.50	12.7	0.20	5.1	0.30	7.6	0.12	3.1	0.02	0.51	Sn/CuFe
60R030	0.29	7.4	0.50	12.7	0.20	5.1	0.30	7.6	0.12	3.1	0.02	0.51	Sn/CuFe
60R040	0.30	7.6	0.53	13.5	0.20	5.1	0.30	7.6	0.12	3.1	0.02	0.51	Sn/CuFe
60R050	0.31	7.9	0.54	13.7	0.20	5.1	0.30	7.6	0.12	3.1	0.02	0.51	Sn/Cu
60R065	0.37	9.4	0.57	14.5	0.20	5.1	0.30	7.6	0.12	3.1	0.02	0.51	Sn/Cu
60R075	0.40	10.2	0.59	15	0.20	5.1	0.30	7.6	0.12	3.1	0.02	0.51	Sn/Cu
60R090	0.44	11.2	0.62	15.8	0.20	5.1	0.30	7.6	0.12	3.1	0.02	0.51	Sn/Cu
60R110	0.51	13	0.72	18.2	0.20	5.1	0.30	7.6	0.12	3.1	0.03	0.81	Sn/Cu
60R135	0.53	13.58	0.78	19.8	0.20	5.1	0.30	7.6	0.12	3.1	0.03	0.81	Sn/Cu
60R160	0.60	15.36	0.85	21.6	0.20	5.1	0.30	7.6	0.12	3.1	0.03	0.81	Sn/Cu
60R185	0.66	16.76	0.91	23	0.20	5.1	0.30	7.6	0.12	3.1	0.03	0.81	Sn/Cu
60R250	0.78	19.93	1.03	26.2	0.40	10.2	0.30	7.6	0.12	3.1	0.03	0.81	Sn/Cu
60R300	0.91	23.11	1.15	29.3	0.40	10.2	0.30	7.6	0.12	3.1	0.03	0.81	Sn/Cu
60R375	1.04	26.3	1.22	31.1	0.40	10.2	0.30	7.6	0.12	3.1	0.03	0.81	Sn/Cu

Part Marking System

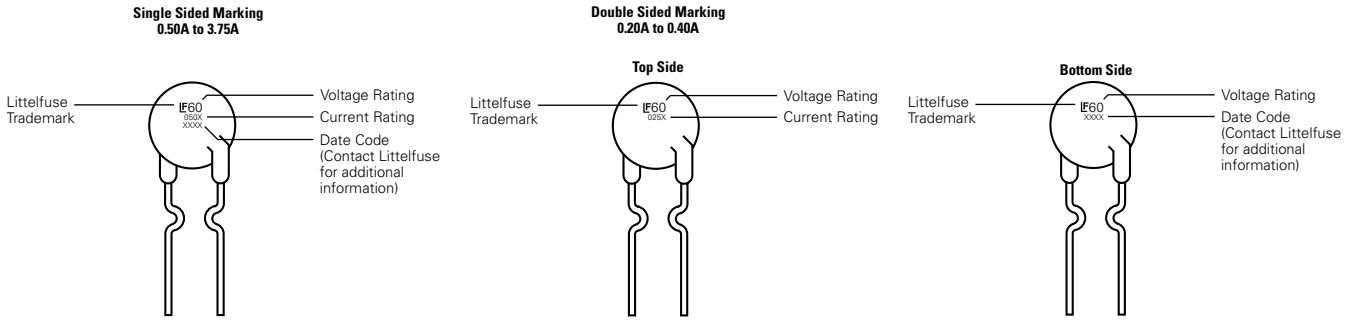

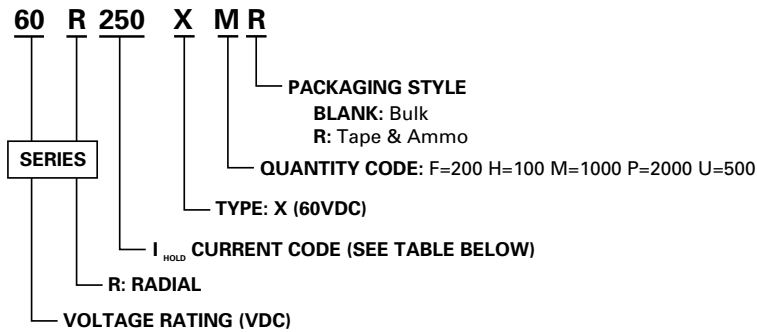
Part Numbering System

Packaging

I _{hold} (A)	I _{hold} Code	Packaging Option	Quantity	Quantity & Packaging Codes
0.10	010	Bulk	500	U
		Tape and Ammo	2000	PR
0.20	020	Bulk	500	U
		Tape and Ammo	2000	PR
0.30	030	Bulk	500	U
		Tape and Ammo	2000	PR
0.40	040	Bulk	500	U
		Tape and Ammo	2000	PR
0.50	050	Bulk	500	U
		Tape and Ammo	2000	PR
0.65	065	Bulk	500	U
		Tape and Ammo	2000	PR
0.75	075	Bulk	500	U
		Tape and Ammo	2000	PR
0.90	090	Bulk	500	U
		Tape and Ammo	2000	PR
1.10	110	Bulk	500	U
		Tape and Ammo	1000	MR
1.35	135	Bulk	200	F
		Tape and Ammo	1000	MR
1.60	160	Bulk	200	F
		Tape and Ammo	1000	MR
1.85	185	Bulk	200	F
		Tape and Ammo	1000	MR
2.50	250	Bulk	200	F
		Tape and Ammo	1000	MR
3.00	300	Bulk	200	F
3.75	375	Bulk	100	H

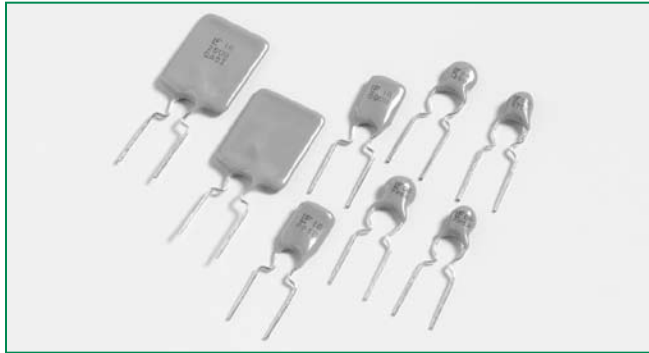
RoHS USBR Series



Description

- The USBR series radial leaded device is designed to provide overcurrent protection for USB applications where space is not a concern.

Features

- RoHS compliant and lead-free
- Fast time-to-trip
- Meets all USB protection requirements
- 40A short circuit rating
- Operating voltages of 6-16V

Applications

- Computers & peripherals
- Any USB application

Agency Approvals

AGENCY	AGENCY FILE NUMBER
	E183209
	R50082521

Electrical Characteristics

Part Number	I _{hold} (A)	I _{trip} (A)	V _{max} (Vdc)	I _{max} (A)	P _d max. (W)	Maximum Time To Trip		Resistance		Agency Approvals	
						Current (A)	Time (Sec.)	R _{min} (Ω)	R _{1max} (Ω)		
06R075B	0.75	1.30	6	40	0.3	8.00	0.4	0.100	0.230	X	X
06R120B	1.20	2.00	6	40	0.6	8.00	0.5	0.065	0.140	X	X
06R155B	1.55	2.70	6	40	0.6	7.75	2.2	0.040	0.100	X	X
16R090B	0.90	1.80	16	40	0.6	8.00	1.2	0.070	0.180	X	X
16R110B	1.10	2.20	16	40	0.7	8.00	2.3	0.050	0.140	X	X
16R135B	1.35	2.70	16	40	0.8	8.00	4.5	0.040	0.120	X	X
16R160B	1.60	3.20	16	40	0.9	8.00	9.0	0.030	0.110	X	X
16R185B	1.85	3.70	16	40	1.0	8.00	10.0	0.030	0.090	X	X
16R250B	2.50	5.00	16	40	1.2	8.00	40.0	0.020	0.060	X	X

I_{hold} = Hold current: maximum current device will pass without tripping in 20°C still air.
 I_{trip} = Trip current: minimum current at which the device will trip in 20°C still air.
 V_{max} = Maximum voltage device can withstand without damage at rated current (I_{max})
 I_{max} = Maximum fault current device can withstand without damage at rated voltage (V_{max})
 P_d = Power dissipated from device when in the tripped state at 20°C still air.

R_{min} = Minimum resistance of device in initial (un-soldered) state.
 R_{typ} = Typical resistance of device in initial (un-soldered) state.
 R_{1max} = Maximum resistance of device at 20°C measured one hour after tripping or reflow soldering of 260°C for 20 sec.

Caution: Operation beyond the specified rating may result in damage and possible arcing and flame.

Temperature Derating

Part Number	Ambient Operation Temperature								
	-40°C	-20°C	0°C	23°C	40°C	50°C	60°C	70°C	85°C
06R075B	1.05	0.95	0.85	0.75	0.65	0.60	0.55	0.50	0.43
06R120B	1.69	1.52	1.36	1.20	1.04	0.96	0.88	0.80	0.68
06R155B	2.17	1.96	1.75	1.55	1.34	1.24	1.13	1.03	0.88
16R090B	1.31	1.17	1.04	0.90	0.75	0.69	0.61	0.55	0.47
16R110B	1.60	1.43	1.27	1.10	1.00	0.92	0.75	0.67	0.57
16R135B	1.96	1.76	1.55	1.35	1.12	1.04	0.92	0.82	0.70
16R160B	2.32	2.08	1.84	1.60	1.33	1.23	1.09	0.98	0.83
16R185B	2.68	2.41	2.13	1.85	1.54	1.42	1.26	1.13	0.96
16R250B	3.63	3.25	2.88	2.50	2.08	1.93	1.70	1.53	1.30

Average Time Current Curves

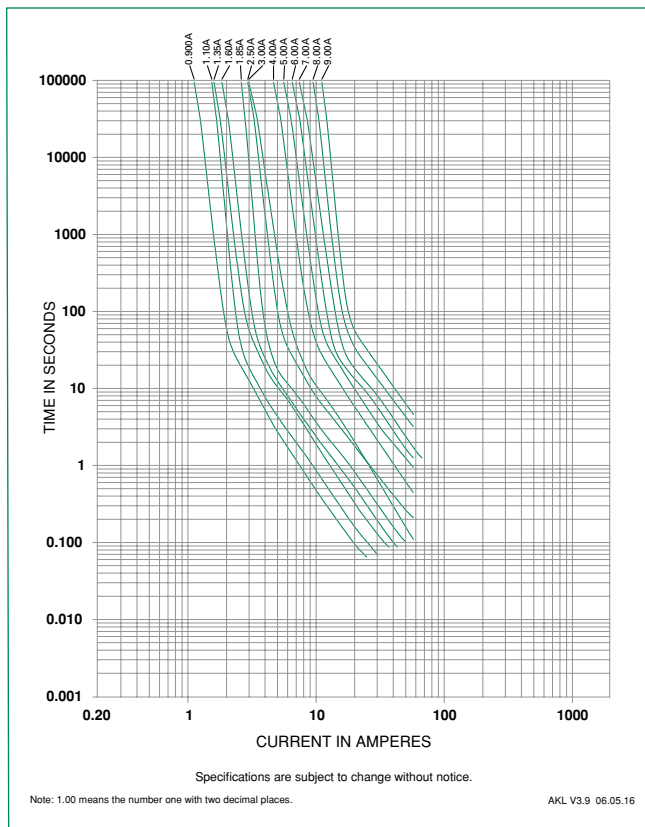

The average time current curves and temperature derating curve performance is affected by a number of variables, and these curves provided as guidance only. Customer must verify the performance in their application.

Temperature Derating Curve

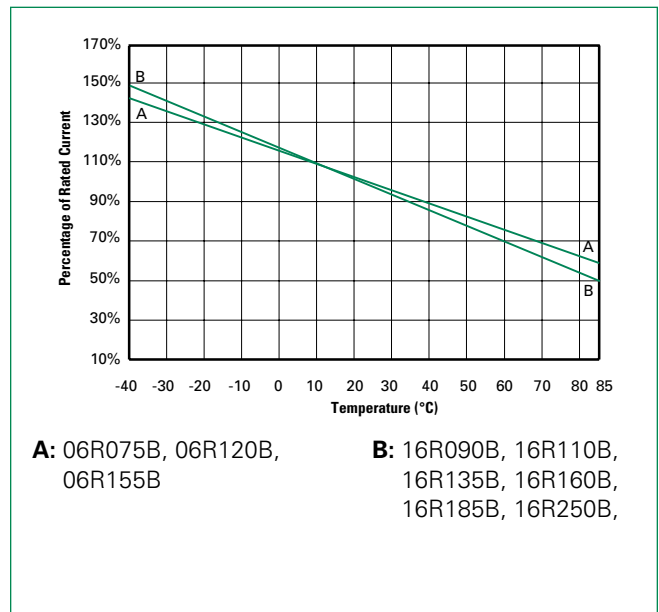

Soldering Parameters - Wave Soldering

Pre-Heating Zone	Refer to the condition recommended by the flux manufacturer. Max. ramping rate should not exceed 4°C/Sec.
Soldering Zone	Max. solder temperature should not exceed 260°C
Cooling Zone	Cooling by natural convection in air.

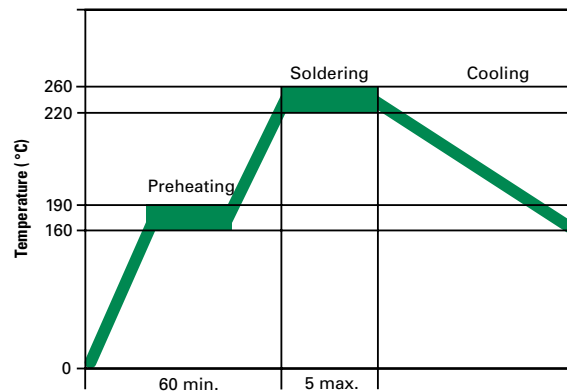

Physical Specifications

Lead Material	.90-2.50A: Tin-plated copper clad steel .75A: Tin-plated copper
Soldering Characteristics	Solderability per MIL-STD-202, Method 208E
Insulating Material	Cured, flame retardant epoxy polymer meets UL94V-0 requirements.
Device Labeling	Marked with LF, voltage, current rating, and date code.

Environmental Specifications

Operating/Storage Temperature	-40°C to +85°C
Maximum Device Surface Temperature in Tripped State	125°C
Passive Aging	+85°C, 1000 hours ±5% typical resistance change
Humidity Aging	+85°C, 85%R.H. 1000 hours ±5% typical resistance change
Thermal Shock	+85°C to -40°C 10 times ±5% typical resistance change
Solvent Resistance	MIL-STD-202, Method 215F

Dimensions (mm)

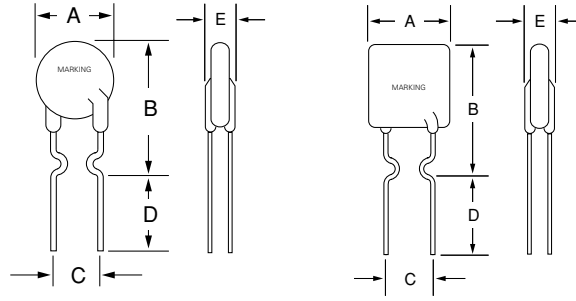
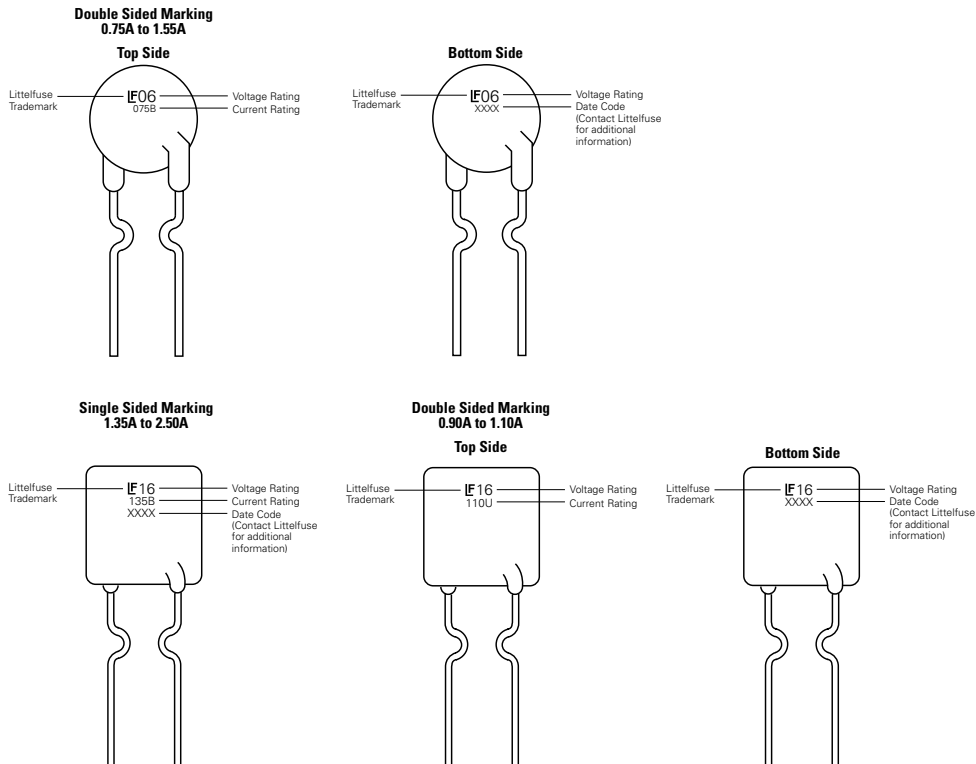

Figure 1

Figure 2

Part Number	A		B		C		D		E		Physical Characteristics			
	Inches	mm	Inches	mm	Inches	mm	Inches	mm	Inches	mm	Lead (dia)		Material	Figure
	Max.	Max.	Max.	Max.	Typ.	Typ.	Min.	Min.	Max.	Max.	Inches	mm		
06R075B	0.27	6.9	0.45	11.4	0.20	5.1	0.30	7.6	0.12	3	0.020	0.51	Sn/Cu	1
06R120B	0.27	6.9	0.46	11.7	0.20	5.1	0.30	7.6	0.12	3	0.020	0.51	Sn/CuFe	1
06R155B	0.27	6.9	0.46	11.7	0.20	5.1	0.30	7.6	0.12	3	0.020	0.51	Sn/CuFe	1
16R090B	0.29	7.4	0.48	12.2	0.20	5.1	0.30	7.6	0.12	3	0.020	0.51	Sn/CuFe	2
16R110B	0.29	7.4	0.56	14.2	0.20	5.1	0.30	7.6	0.12	3	0.020	0.51	Sn/CuFe	2
16R135B	0.35	8.9	0.53	13.5	0.20	5.1	0.30	7.6	0.12	3	0.020	0.51	Sn/CuFe	2
16R160B	0.35	8.9	0.60	15.2	0.20	5.1	0.30	7.6	0.12	3	0.020	0.51	Sn/CuFe	2
16R185B	0.40	10.2	0.62	15.7	0.20	5.1	0.30	7.6	0.12	3	0.020	0.51	Sn/CuFe	2
16R250B	0.45	11.4	0.72	18.3	0.20	5.1	0.30	7.6	0.12	3	0.020	0.51	Sn/CuFe	2

Part Marking System



Part Numbering System

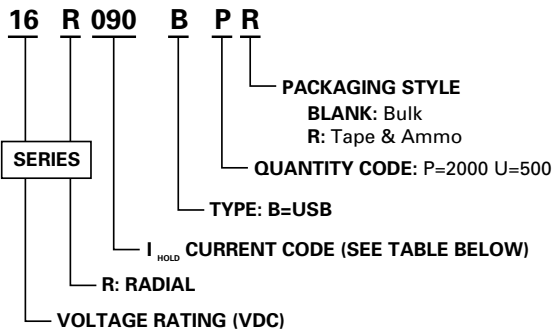

Packaging

I_{hold} (A)	I_{hold} Code	Voltage	Packaging Option	Quantity	Quantity & Packaging Codes
0.75	075	6	Bulk	500	U
			Tape and Ammo	2000	PR
1.20	120	6	Bulk	500	U
			Tape and Ammo	2000	PR
1.55	155	6	Bulk	500	U
			Tape and Ammo	2000	PR
0.90	080	16	Bulk	500	U
			Tape and Ammo	2000	PR
1.10	110	16	Bulk	500	U
			Tape and Ammo	2000	PR
1.35	135	16	Bulk	500	U
			Tape and Ammo	2000	PR
1.60	160	16	Bulk	500	U
			Tape and Ammo	2000	PR
1.85	185	16	Bulk	500	U
			Tape and Ammo	2000	PR
2.50	250	16	Bulk	500	U
			Tape and Ammo	2000	PR