

1MBI300S-120

IGBT Module

1200V / 300A 1 in one-package

■ Features

- High speed switching
- Voltage drive
- Low inductance module structure

■ Applications

- Inverter for Motor drive
- AC and DC Servo drive amplifier
- Uninterruptible power supply
- Industrial machines, such as Welding machines

■ Maximum ratings and characteristics

● Absolute maximum ratings (at Tc=25°C unless otherwise specified)

Item	Symbol	Rating	Unit		
Collector-Emitter voltage	V _{CEs}	1200	V		
Gate-Emitter voltage	V _{GES}	±20	V		
Collector current	Continuous	T _c =25°C	I _C	400	A
		T _c =80°C		300	A
	1ms	T _c =25°C	I _C pulse	800	A
		T _c =80°C		600	A
		-I _c	300	A	
	-I _c pulse	600	A		
Max. power dissipation	P _c	2100	W		
Operating temperature	T _j	+150	°C		
Storage temperature	T _{stg}	-40 to +125	°C		
Isolation voltage *1	V _{is}	AC 2500 (1min.)	V		
Screw torque	Mounting *2	3.5	N·m		
	Terminals *2	4.5	N·m		
	Terminals *2	1.7	N·m		

*1 : All terminals should be connected together when isolation test will be done

*2 : Recommendable value : Mounting 2.5 to 3.5 N·m(M5 or M6)

Terminal 3.5 to 4.5 N·m(M6), 1.3 to 1.7N·m(M4)

● Electrical characteristics (at Tj=25°C unless otherwise specified)

Item	Symbol	Characteristics			Conditions	Unit
		Min.	Typ.	Max.		
Zero gate voltage collector current	I _{CEs}	–	–	4.0	V _{GE} =0V, V _{CE} =1200V	mA
Gate-Emitter leakage current	I _{GES}	–	–	0.8	V _{CE} =0V, V _{GE} =±20V	μA
Gate-Emitter threshold voltage	V _{GE(th)}	5.5	7.2	8.5	V _{CE} =20V, I _c =300mA	V
Collector-Emitter saturation voltage	V _{CE(sat)}	–	2.3	2.6	T _c =25°C, V _{GE} =15V, I _c =300A	V
		–	2.8	–	T _c =125°C	
Input capacitance	C _{ies}	–	36000	–	V _{GE} =0V	pF
Output capacitance	C _{oes}	–	7500	–	V _{CE} =10V	
Reverse transfer capacitance	C _{res}	–	6600	–	f=1MHz	
Turn-on time	t _{on}	–	0.35	1.2	V _{CC} =600V I _c =300A V _{GE} =±15V R _G =2.7 ohm	μs
	t _r	–	0.25	0.6		
	t _{r(i)}	–	0.1	–		
Turn-off time	t _{off}	–	0.45	1.0		
	t _f	–	0.08	0.3		
Forward on voltage	V _F	–	2.7	3.5	T _j =25°C, I _F =300A, V _{GE} =0V	V
		–	2.4	–	T _j =125°C	
Reverse recovery time	t _{rr}	–	–	0.35	I _F =300A	μs

● Thermal resistance characteristics

Item	Symbol	Characteristics			Conditions	Unit
		Min.	Typ.	Max.		
Thermal resistance	R _{th(j-c)}	–	–	0.06	IGBT	°C/W
	R _{th(j-c)}	–	–	0.17	FWD	°C/W
	R _{th(c-f)*4}	–	0.0125	–	the base to cooling fin	°C/W

*4 : This is the value which is defined mounting on the additional cooling fin with thermal compound



■ Equivalent Circuit Schematic

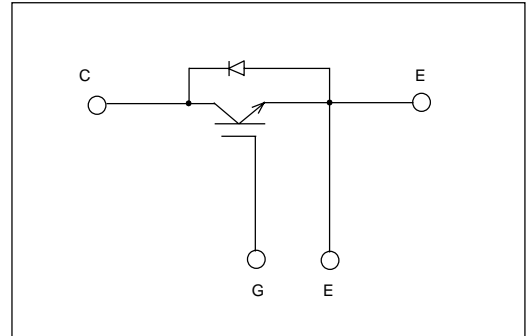

Characteristics

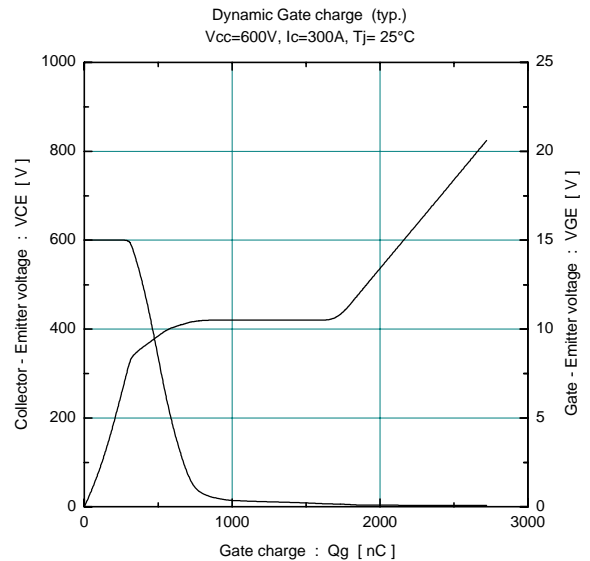
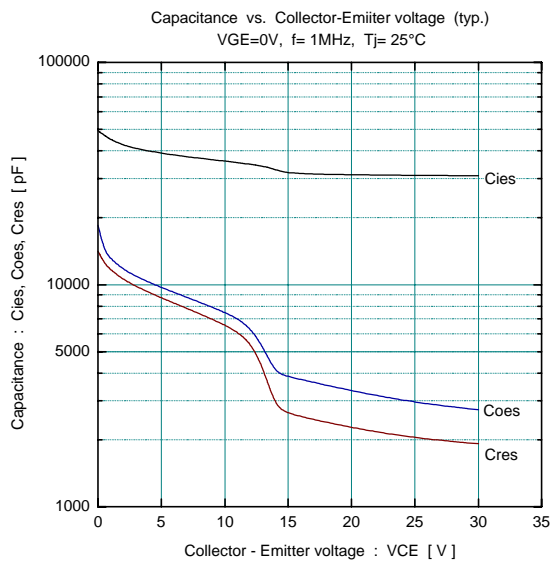
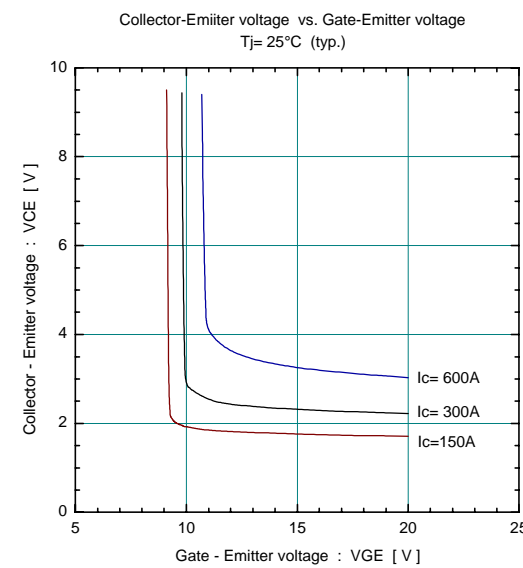
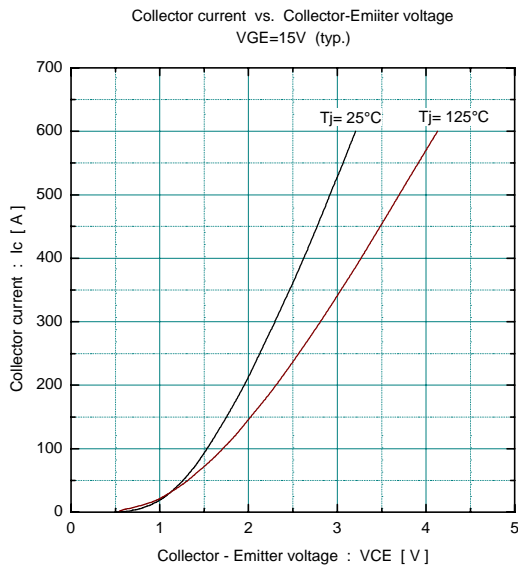
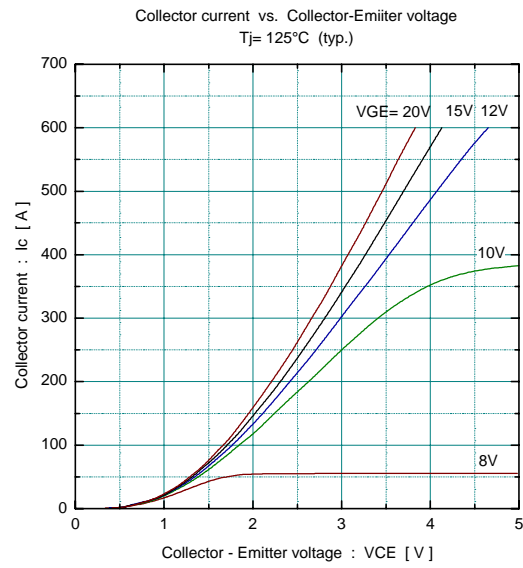
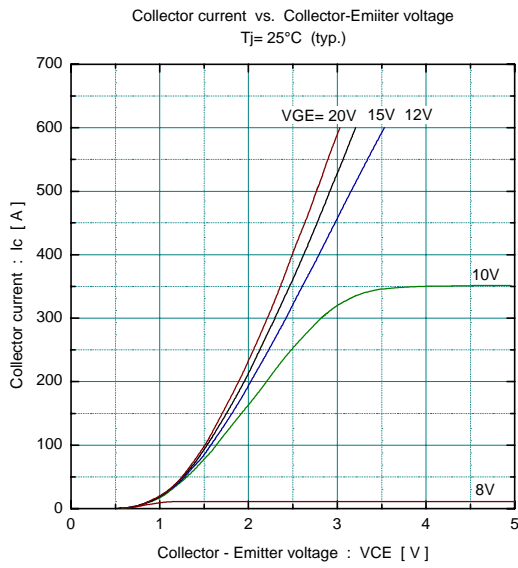

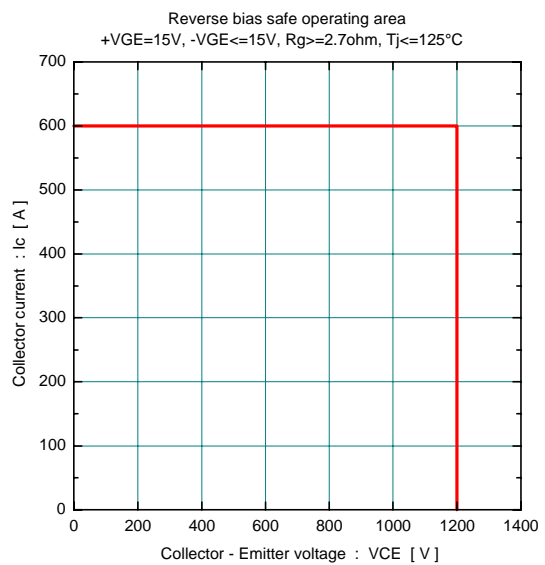
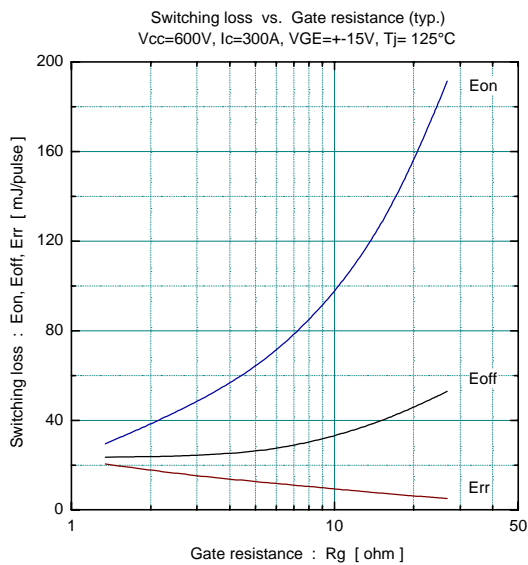
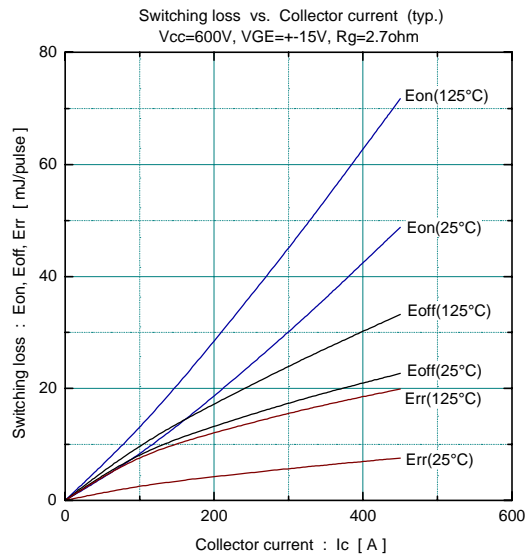
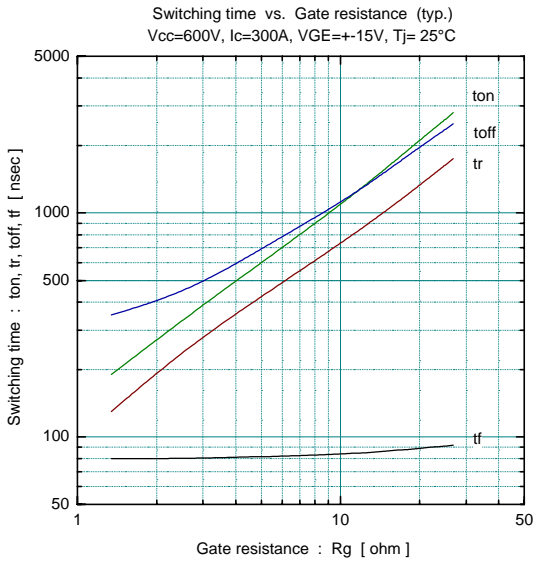
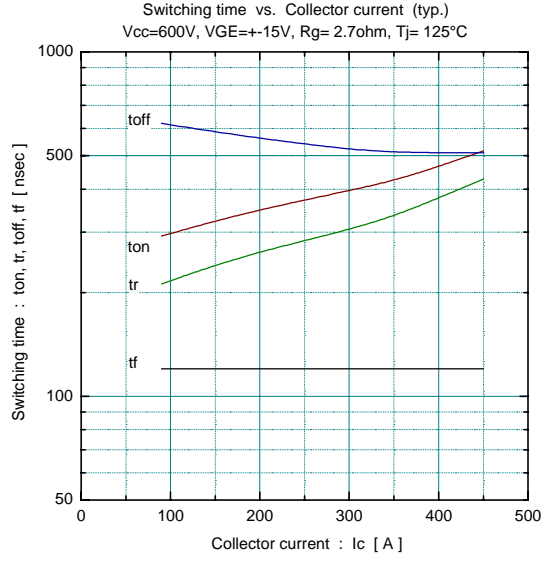
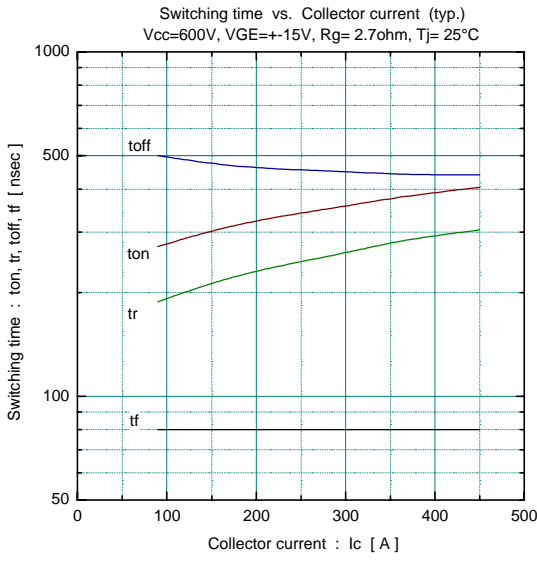

Forward current vs. Forward on voltage (typ.)

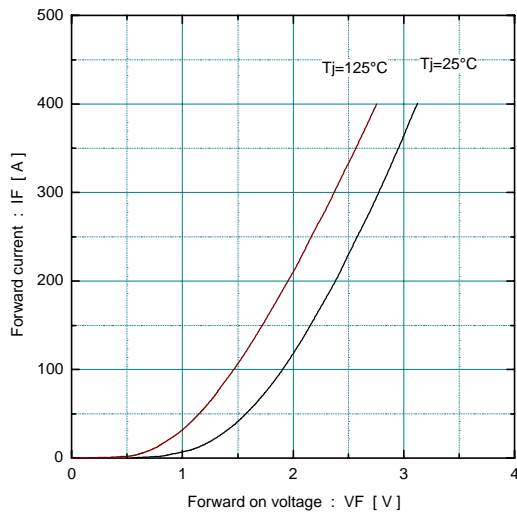

Reverse recovery characteristics (typ.)
Vcc=600V, VGE=+-15V, Rg=2.7ohm

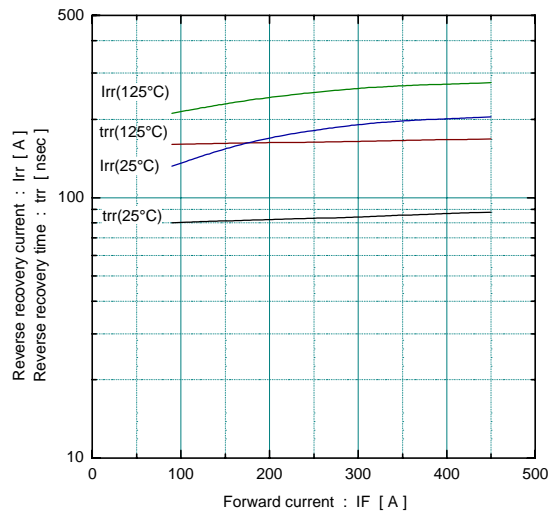

Transient thermal resistance

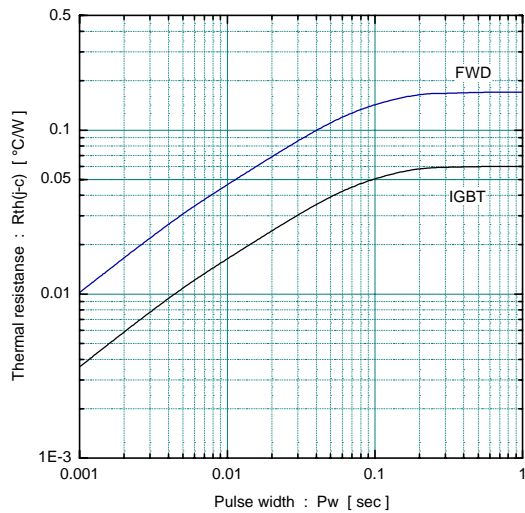

■ Outline Drawings, mm

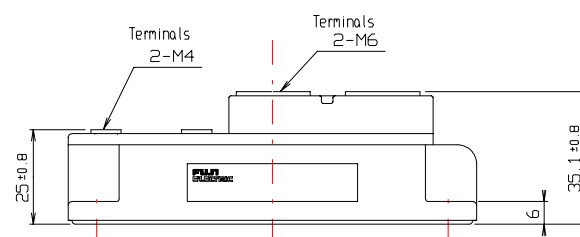
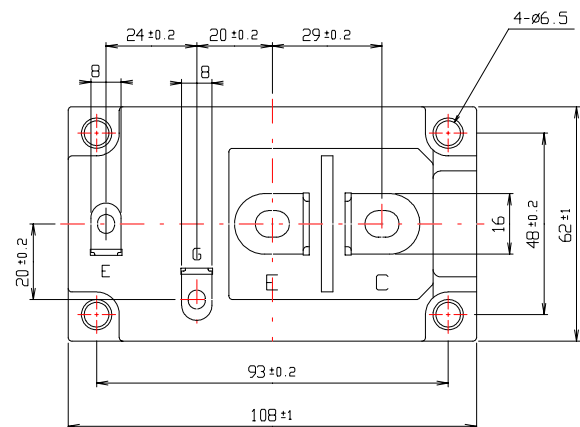

mass : 380g