

# multimec® 3F + 1D/1E/1F

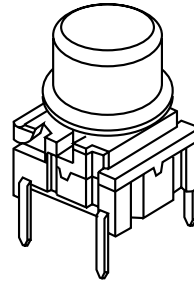

### Technical Data:

- through-hole or SMD
- 50mA/24VDC
- single pole/momentary
- 10.000.000 operations life time
- IP67 sealing
- temperature range:  
low temp: -40/+115°C  
high temp: -40/+160°C

### Dimensions (through-hole)

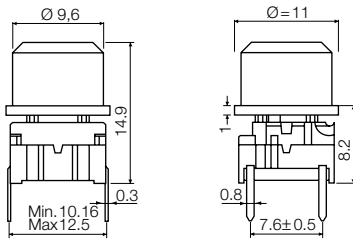

### PCB layout

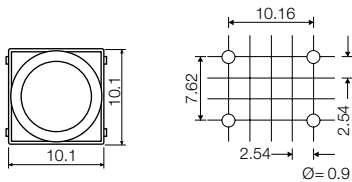

### Dimensions (w/LED)

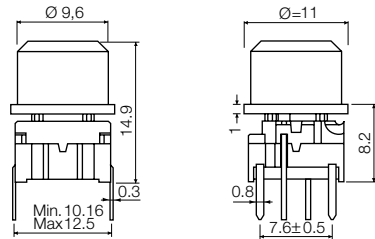

### PCB layout (top view)

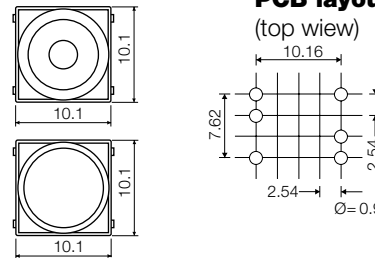

### Dimensions (SMD)

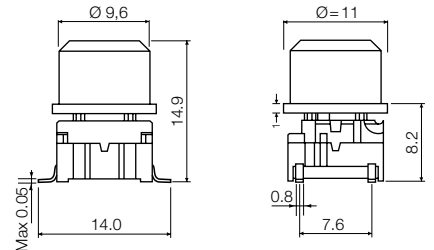

### PCB layout

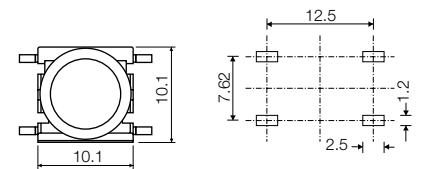



### HOW TO ORDER

<b>3 F</b>	<input type="checkbox"/>	<input type="checkbox"/>	<b>+</b>	<input type="checkbox"/>	<b>1 D</b>	<input type="checkbox"/>	<input type="checkbox"/>	<input type="checkbox"/>
<b>Switch</b>	<b>Mounting</b>	<b>L 6</b> low temp.		<b>Cap</b>	<b>00</b> blue	<b>30</b> ultra blue	<b>50</b> metal dark blue	
	<b>T</b> through-hole	<b>H 9</b> high temp.			<b>02</b> green	<b>40</b> dusty blue	<b>53</b> metal light grey	
	<b>S</b> surface mount				<b>03</b> grey	<b>42</b> aqua blue	<b>57</b> metal dark grey	
					<b>04</b> yellow	<b>32</b> mint green	<b>58</b> metal bordeaux	
					<b>06</b> white	<b>33</b> tele grey		
					<b>08</b> red	<b>34</b> melon		
					<b>09</b> black	<b>38</b> noble red		

### Standard versions:

3FTL6  
3FTH9  
3FSH9  
3FSH9R

<b>3 F</b>	<b>T</b>	<input type="checkbox"/>	<b>+</b>	<input type="checkbox"/>	<b>1 1</b>	<input type="checkbox"/>
<b>Switch</b>	<b>Mounting</b>	<b>L 6</b> low temp.		<b>Cap 1D</b>	transparent	<b>Lens</b>
	<b>T</b> through-hole	<b>H 9</b> high temp.				
				<b>Cap 1E</b>	<b>00</b> blue	<b>1</b> transparent
					<b>20</b> green	<b>2</b> green
				<b>Cap 1F</b>	<b>40</b> yellow	<b>4</b> yellow
					<b>80</b> red	<b>8</b> red
					<b>2040</b> green/yellow	
					<b>8020</b> red/green	
					<b>8040</b> red/yellow	
					<b>03</b> grey	
					<b>04</b> yellow	
					<b>06</b> white	
					<b>08</b> red	
					<b>09</b> black	

Ordering example: 3FTL620 + 1E032

# multimec® 3F + 1K + 2K

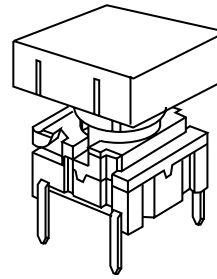
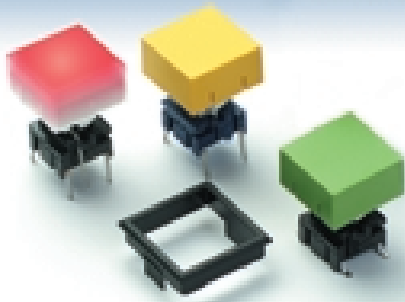

### Technical Data:

- through-hole or SMD
- 50mA/24VDC
- single pole/momentary
- 10.000.000 operations life time
- IP67 sealing
- temperature range:  
low temp: -40/+115°C  
high temp: -40/+160°C

### Dimensions (through-hole)

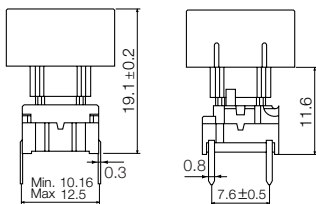

### PCB layout

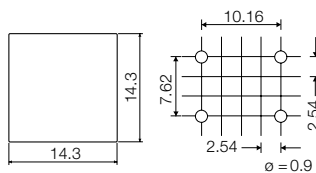

### Dimensions (w/LED)

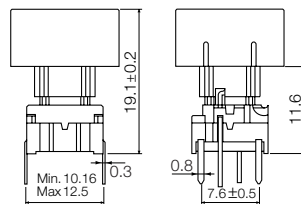

### PCB layout (top view)

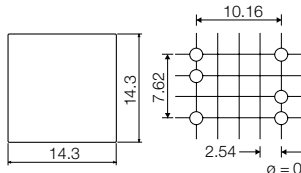

### Dimensions (SMD)

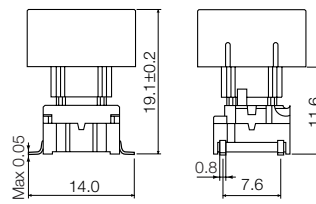

### PCB layout

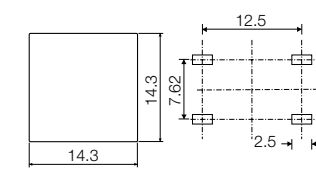

### Dimensions (Bezel) (Optional)

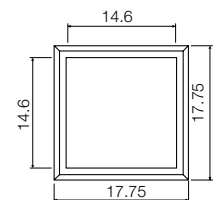
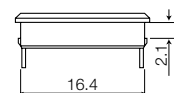

### HOW TO ORDER

<b>3 F</b>	<input type="checkbox"/>	<input type="checkbox"/>	+	<b>1 K</b>	<b>1 6</b>	+	<b>2 K</b>	<input type="checkbox"/>
<b>Switch</b>	<b>Mounting</b>	<b>L 6</b> low temp. <b>H 9</b> high temp.		<b>Cap</b>	<b>00</b> blue <b>02</b> green <b>03</b> grey <b>04</b> yellow <b>06</b> white <b>08</b> red <b>09</b> black		<b>Bezel</b>	<b>03</b> grey <b>06</b> white <b>08</b> red <b>09</b> black

### Standard versions:

3FTL6  
3FTH9  
3FSH9  
3FSH9R

<b>3 F</b>	<b>T</b>	<input type="checkbox"/>	<input type="checkbox"/>	+	<b>1 K 1 1 1 6</b>	+	<b>2 K</b>	<input type="checkbox"/>
<b>Switch</b>	<b>Mounting</b>	<b>L 6</b> low temp. <b>H 9</b> high temp.	<b>LED</b>		<b>Cap</b> transparent		<b>Bezel</b>	<b>03</b> grey <b>06</b> white <b>08</b> red <b>09</b> black
	<b>T</b> through-hole		<b>23</b> green <b>44</b> yellow <b>88</b> red					

### Standard versions:

3FTL622  
3FTL644  
3FTL688

**Ordering example:** 3FTL688 + 1K1116

# multimec® 3F + 1P/1Q/1R

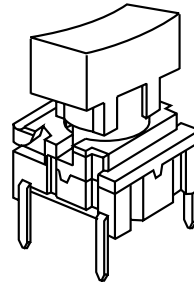

### Technical Data:

- through-hole or SMD
- 50mA/24VDC
- single pole/momentary
- 10.000.000 operations life time
- IP67 sealing
- temperature range:  
low temp: -40/+115°C  
high temp: -40/+160°C

### Dimensions (through-hole)

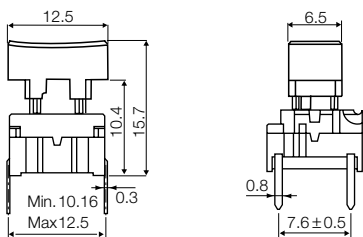

### PCB layout

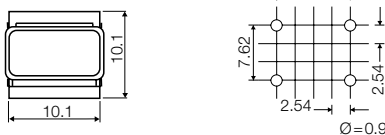

### Dimensions (w/LED)

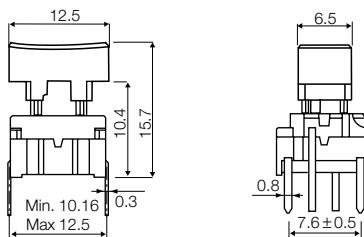

### PCB layout (top view)

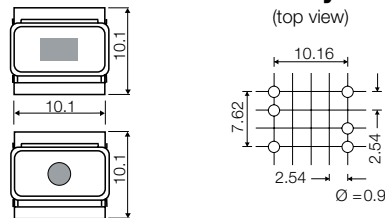

### Dimensions (SMD)

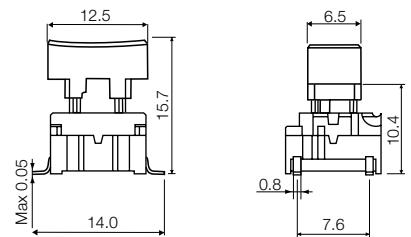

### PCB layout

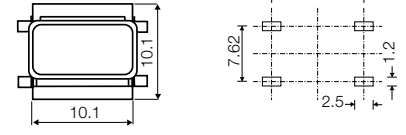

### How to order

**3 F**

**Switch**



**Mounting**

**T** through-hole  
**S** surface mount



**L 6** low temp.  
**H 9** high temp.

+

**1 P**

**Cap**



**00** blue  
**02** green  
**03** grey  
**04** yellow  
**06** white  
**08** red  
**09** black

### Standard versions:

3FTL6  
3FTH9  
3FSH9  
3FSH9R

**3 F**

**Switch**



**Mounting**

**T** through-hole



**L 6** low temp.  
**H 9** high temp.



**LED**

**00** blue  
**20** green  
**40** yellow  
**80** red  
**2040** green/yellow  
**8020** red/green  
**8040** red/yellow

+



**1Q**



**00** blue  
**03** grey  
**08** red  
**09** black

**1**

**Lens**

**1** transparent

### Standard versions:

3FTL600  
3FTL620  
3FTL640  
3FTL680  
3FTL62040  
3FTL68020  
3FTL68040

**1R**



**Ordering example:** 3 FTL680 + 1Q091

# multimec® RAS + 1D/1K/1P/1S

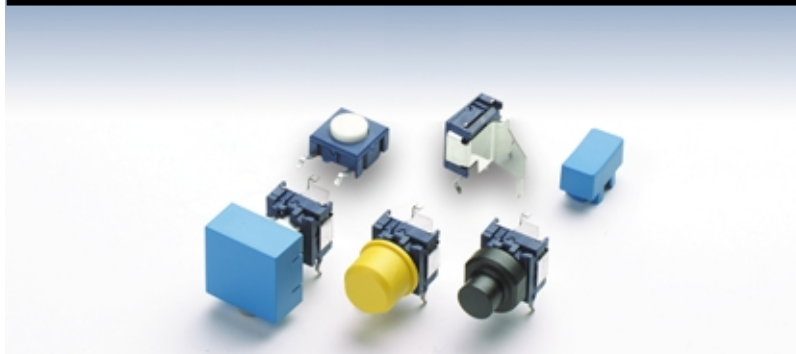

## Technical Data:

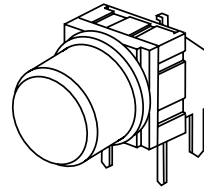

- through-hole only
- 50mA/24VDC
- single pole/momentary
- 10.000.000 operations life time
- IP67 sealing
- temperature range:  
low temp: -40/+115°C

### Dimensions 1D

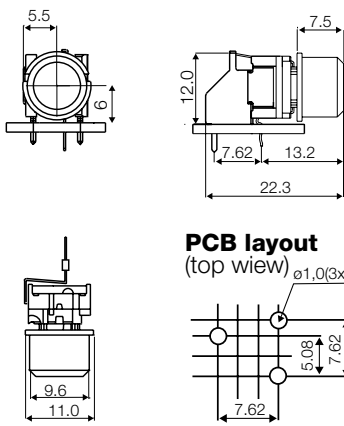

### Dimensions 1K

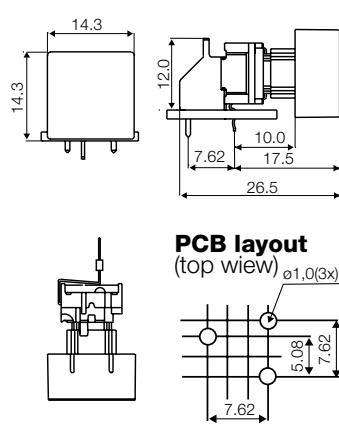

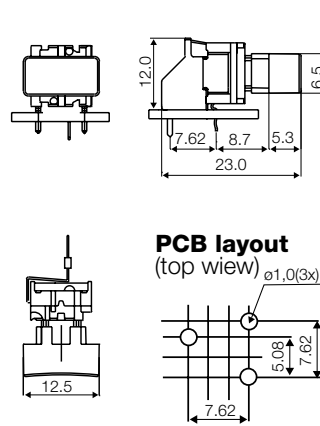

### Dimensions 1P

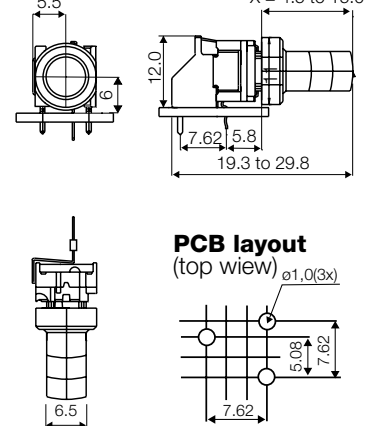

### Dimensions 1S

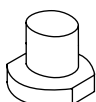

## HOW TO ORDER

<b>3 F</b>	<b>T</b>	<b>L 6</b>	<b>R A S</b>	+	<b>1 D</b>			
<b>Switch</b>	<b>Mounting</b> T through-hole	<b>L 6</b> low temp.	Right angle support		<b>Cap</b>	<b>00</b> blue	<b>30</b> ultra blue	<b>50</b> metal dark blue
						<b>02</b> green	<b>40</b> dusty blue	<b>53</b> metal light grey
						<b>03</b> grey	<b>42</b> aqua blue	<b>57</b> metal dark grey
						<b>04</b> yellow	<b>32</b> mint green	<b>58</b> metal bordeaux
						<b>06</b> white	<b>33</b> tele grey	
						<b>08</b> red	<b>34</b> melon	
						<b>09</b> black	<b>38</b> noble red	
					<b>1 P</b>	<b>00</b> blue		
					<b>Cap</b>	<b>03</b> grey		
						<b>08</b> red		
						<b>09</b> black		
					<b>1 K</b>	<b>1 6</b>	+	<b>2 K</b>
					<b>Cap</b>	<b>00</b> blue		<b>Bezel</b>
						<b>02</b> green		<b>03</b> grey
						<b>03</b> grey		<b>06</b> white
						<b>04</b> yellow		<b>08</b> red
						<b>06</b> white		<b>09</b> black
						<b>08</b> red		
						<b>09</b> black		
					<b>1 S 0 9</b>	<b>-</b>		<b>.</b>
					<b>Cap black</b>	<b>H</b>		<b>X *</b>
						16.0		8.5
						19.0		11.5
						22.5		15.0

**Standard versions:**  
3FTL6RAS, 3CTL6RAS,

\*Any cap height X from 8.5 to 15.0 mm is available. Please order 1S09-H, where H = X+7.5 mm  
Min. order Qty for custom heights is 2.000 pcs. A start-up charge will apply.  
3CTL6 also available as right angle switch 3CTL6RAS. Please see multimec basic switch modules.

**Ordering example:** 3FTL6RAS + 1K0016 + 2K03

Through-hole Version						
3A	3C	3E	3F	3F	3F	3F
For 1A/1B/1M	w/LED for 1C/1H			For 1D/1K/1N/1P/1S/1T/1U/1V/1X/1GA/1GC	w/LED for 1E/1F/1N/1Q/1R/1S/1X	w/LED for 1K1116/1T/1U/1V
<b>Standard Versions</b>						
3ATL6 3ATH9	3ATL600/20/40/80	3CTL6/3CTL9 3CTH9	3ETL9-H* 3ETH9-H*	3FTL6 3FTH9	3FTL600/20/40/80/ 2040/8020/8040	3FTL623/44/88
* 3E available in 6 standard heights: 08.0, 09.5, 10.4, 11.0, 12.0, 15.0 mm Other heights between 08.0 and 15.0 mm are available upon request						
Specials: Gold contacts, quiet version and actuation force other than 3.0N						

Surface Mount Versions			
3A	3C	3E	3F
3ASH9/3ASH9R	3CSH9/3CSH9R	3ESH9/3ESH9R	3FSH9 / 3FSH9R
For 1A/1B/1M			For 1D/1K/1N/1P/1S/1T/1U/1V/1X/1GA/1GC

Right Angle Versions	
3C	3F
3CTL6RAS	3FTL6RAS
	For 1D/1K/1P/1S

### multimec® Cross Section

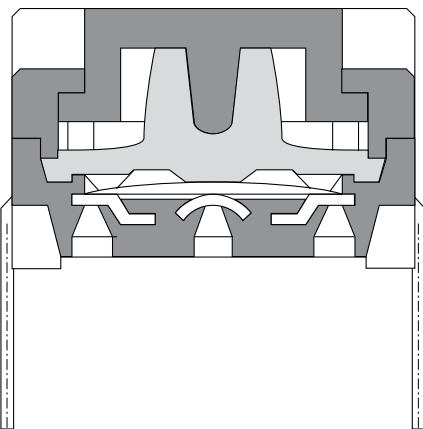

### Recommended PCB layout

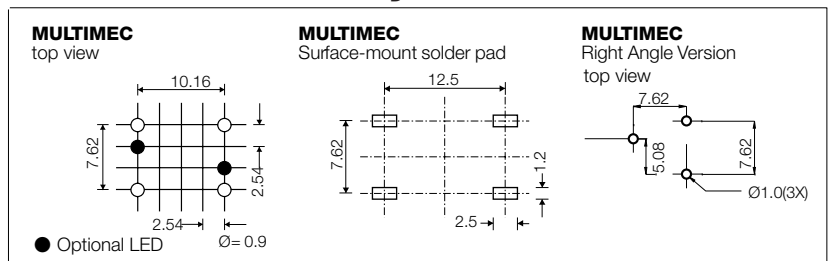

**Operating Force**  
(Typical example)

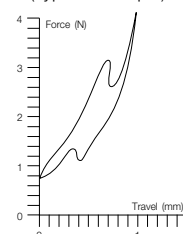

**Circuit diagram**

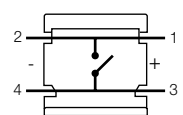

DIMENSIONS (mm) Unless otherwise specified, all tolerances  $\pm 0.2$

	Low Temperature Versions		High Temperature Versions	
	Silver	Gold	Silver	Gold
<b>Electrical Specifications</b>				
Contact resistance	<30 mΩ - typically 10mΩ			
Insulation resistance	>10M Ω			
Recommended load	0.5-50mA 24VDC	0.5μ-50mA 24VDC	0.5-50mA 24VDC	0.5μ-50mA 24VDC
Contact bounce	<2mS - typically 0.5mS			
<b>Mechanical Specifications</b>				
Standard actuation force (switch)	3.0N typ.			
Max. actuation force without cap	100N for 10 sec.			
Key travel (switch)	1 mm			
Life time (switch)	>10.000.000 cycles			
<b>Temperature Range</b>				
Working temperature	Min. -40°C Max. +115°C		Min. -40°C Max. +160°C	
Storage temperature	Min. -40°C Max. +115°C		Min. -40°C Max. +160°C	
Soldering IEC 68-2-20	Wave -max. 260°C for max. 10 sec., please refer to usage guidelines		Infrared, vapour phase, wave - max. 260°C for max. 30 sec.	
	Soldering iron - max. 350°C for max. 3 sec. Flux tight.		Soldering iron - max. 350°C for max. 3 sec. Flux tight.	
<b>Environmental Endurance IEC-68-2-3</b>				
Temperature	+40°C			
Humidity	93% RH			
Duration	56 Days			
<b>Temperature Cycling IEC 68-2-14</b>				
Temperature limit	Min. -55°C - Max. +85°C			
Number of cycles	200			
Exposure time at each temperature	10 min.			
Recovery time before measurements	16 hrs.			
Sealing IEC 529	IP-67			
Cleaning	Standard methods such as freon and water			
<b>Material Specifications - Switches</b>				
Housing	PBT UL94VO		PPS UL94VO	
Actuator	PBT UL94VO		PPS UL94VO	
Sealing + spring	Silicone rubber			
Contact spring	Stainless steel + 3μAg	Stainless steel + 3μAg + 1μAu	Stainless steel + 3μAg	Stainless steel + 3μAg + 1μAu
Fixed Contacts	SnCu + 2μNi + 3μAg	SnCu + 2μNi + 3μAg + 1μAu	SnCu + 2μNi + 3μAg	SnCu + 2μNi + 3μAg + 1μAu
Terminals	SnCu + 2μNi + 3μSnPb	SnCu + 2μNi + 3μSnPb	SnCu + 2μNi + 3μSnPb	SnCu + 2μNi + 3μSnPb
<b>Material Specifications - Caps &amp; Bezels</b>				
<b>Material</b>	<b>Parts</b>	<b>Temp limit</b>	<b>UL rating</b>	
ABS Standard	Standard parts except the below mentioned	Max 65°C	UL94HB	
Polycarbonate	All lenses	Max. 85°C	UL94V1	
LCP	Actuator of 3E	Max. 160°C	UL94VO	
PPS	1S, 2S	Max. 160°C	UL94VO	
Polyamide	Actuator of Varimec , 1GA/ 1GC	Max. 160°C	UL94VO	
<b>Legends Adhesion</b>	ISO Class.: 1/ ASTM Class.: 4B DIN EN ISO 2409			

Specifications are subject to change without notice