

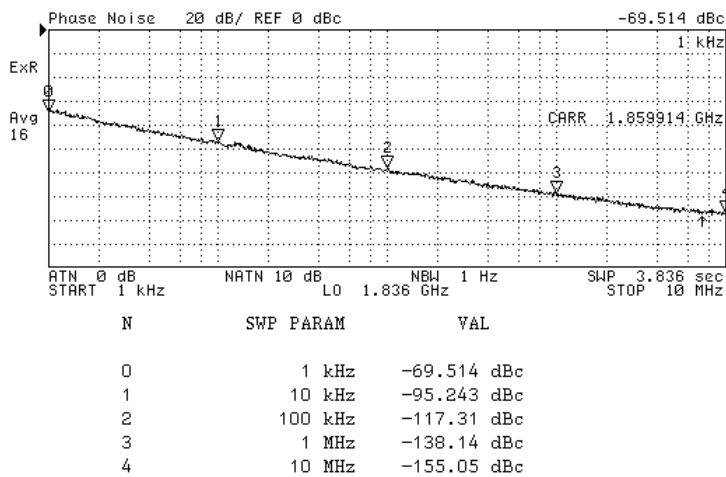

| PERFORMANCE SPECIFICATION                        | MIN  | TYP  | MAX   | UNITS        |
|--------------------------------------------------|------|------|-------|--------------|
| Lower Frequency:                                 |      |      | 1823  | MHz          |
| Upper Frequency:                                 | 1903 |      |       | MHz          |
| Tuning Voltage:                                  | 0.3  |      | 2.55  | VDC          |
| Supply Voltage:                                  | 3.23 | 3.4  | 3.57  | VDC          |
| Output Power:                                    | +2.0 | +6.0 | +10.0 | dBm          |
| Supply Current:                                  |      |      | 15    | mA           |
| Harmonic Suppression (2 <sup>nd</sup> Harmonic): |      | -10  |       | dBc          |
| Pushing:                                         |      |      | 3.0   | MHz/V        |
| Pulling, all Phases:                             |      |      | 5.0   | MHz pk-pk    |
| Tuning Sensitivity:                              |      | 53   |       | MHz/V        |
| Phase Noise @ 10kHz offset:                      |      | -95  |       | dBc/Hz       |
| Phase Noise @ 100kHz offset:                     |      | -116 |       | dBc/Hz       |
| Load Impedance:                                  |      | 50   |       | $\Omega$     |
| Input Capacitance:                               |      |      | 47    | pF           |
| Operating Temperature Range:                     | -40  |      | +85   | $^{\circ}$ C |
| Storage Temperature Range:                       | -45  |      | +90   | $^{\circ}$ C |

Phase Noise  
(1 Hz BW, Typical)



Tuning Curve  
(Typical)

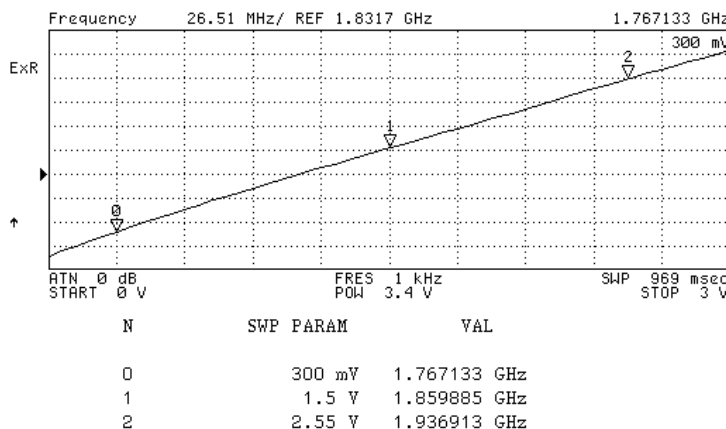

Gold Finish

**BOTTOM VIEW**

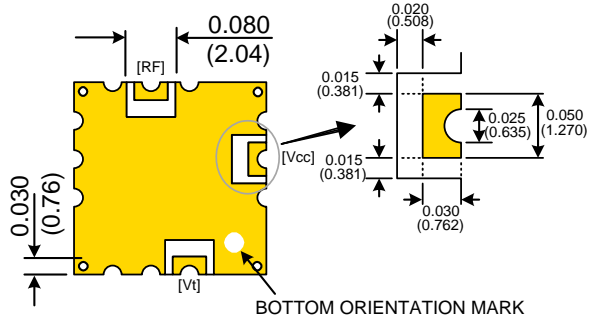

**SIDE VIEW**

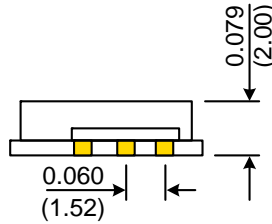

**TOP VIEW**

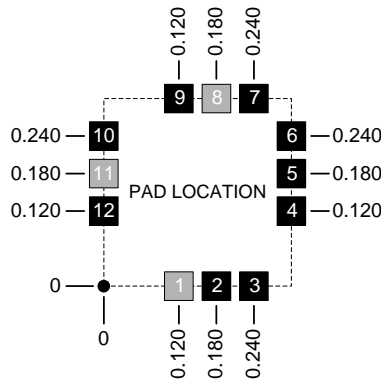
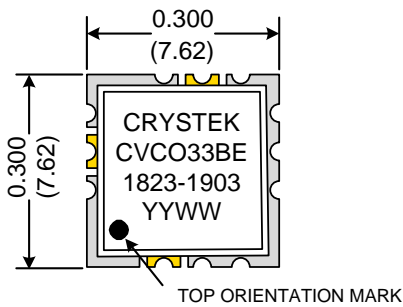

| Pad    | Connection |
|--------|------------|
| 1      | Vt         |
| 8      | RF-OUTPUT  |
| 11     | Vcc        |
| Others | GROUND     |

- Unless otherwise specified, Dimensions are in:  $\frac{IN}{(mm)}$
- Pad Location Dimensions are in: Inches

**TAPE AND REEL**

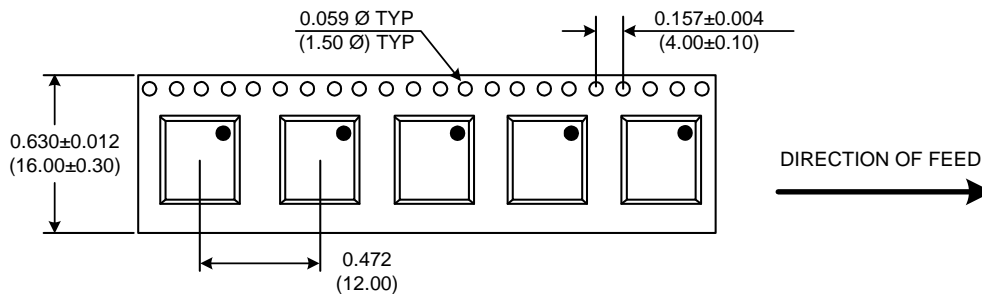

Drawing not to scale

**Product Control:**

|                      |                    |               |           |
|----------------------|--------------------|---------------|-----------|
| Crystek Part Number: | CVCO33BE-1823-1903 | Release Date: | 20-Feb-08 |
| Revision Level:      | B                  | Responsible:  | C. Vales  |

Specification is subject to change without notice