

GBPC25005 thru GBPC2510

Single Phase Bridge Rectifiers

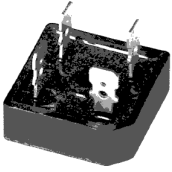

Dimensions GBPC

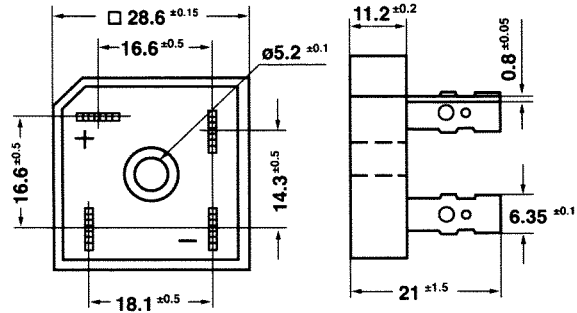

	V _{RRM} V	V _{RMS} V	V _{DC} V
GBPC25005	50	35	50
GBPC2501	100	70	100
GBPC2502	200	140	200
GBPC2504	400	280	400
GBPC2506	600	420	600
GBPC2508	800	560	800
GBPC2510	1000	700	1000

Symbol	Characteristics	Maximum Ratings	Unit
I _{AV}	Maximum Average Forward Rectified Current @T _c =60°C (With Heatsink)	25.0	A
I _{FSM}	Peak Forward Surge Current 8.3ms Single Half-Sine-Wave Superimposed On Rated Load (JEDEC METHOD)	350	A
V _F	Maximum Forward Voltage At 12.5A DC	1.1	V
I _R	Maximum DC Reverse Current At Rated DC Blocking Voltage	@T _J =25°C 5.0 @T _J =125°C 500	uA
I ² t	I ² t Rating For Fusing (t < 8.3 ms), (Note 1)	374	A ² S
C _J	Typical Junction Capacitance Per Element (Note 2)	130	pF
R _{θJC}	Typical Thermal Resistance (Note 3)	1.3	°C/W
T _J	Operating Temperature Range	-55 to +150	°C
T _{stg}	Storage Temperature Range	-55 to +150	°C

NOTES: 1. Measured At Non-repetitive, For Greater Than 1ms And Less Than 8.3ms.
2. Measured At 1.0MHz And Applied Reverse Voltage Of 4.0V DC.
3. Device Mounted On 300mm x 300mm x 1.6mm Cu Plate Heatsink.

FEATURES

- * Rating to 1000V PRV
- * High efficiency
- * Glass passivated chip junction
- * Electrically isolated metal case for maximum heat dissipation

MECHANICAL DATA

- * Case: Molded plastic with Heatsink internally mounted in the bridge encapsulation
- * Polarity: As marked on Body
- * Mounting: Hole for # 10 screw
- * Weight: 0.63 ounces, 18.0 grams

GBPC25005 thru GBPC2510

Single Phase Bridge Rectifiers

FIG.1 - FORWARD CURRENT DERATING CURVE

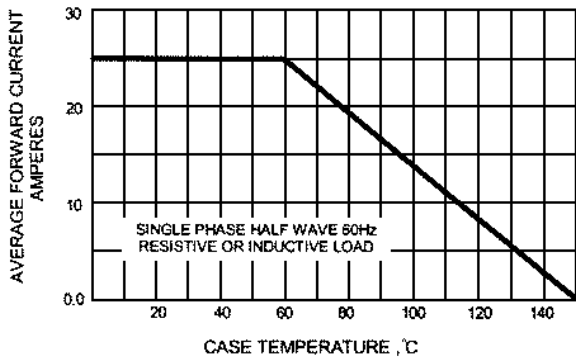

FIG.2 - MAXIMUM NON-REPETITIVE SURGE CURRENT

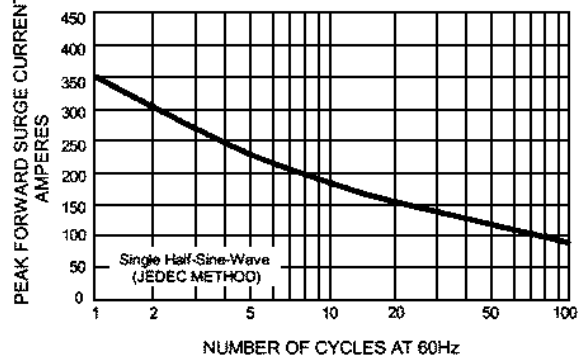

FIG.3 - TYPICAL JUNCTION CAPACITANCE

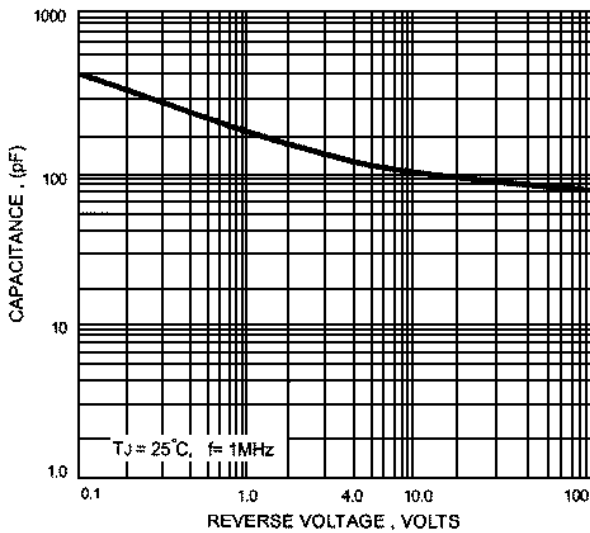

FIG.4 - TYPICAL FORWARD CHARACTERISTICS

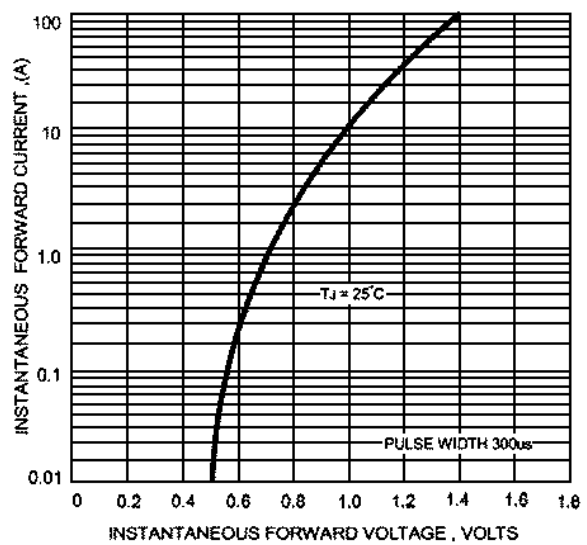

FIG.5 - TYPICAL REVERSE CHARACTERISTICS

