

Data Sheet

Features

- For WCDMA Multicarrier applications
- Usable bandwidth of 35.0 MHz
- High attenuation
- Single-ended operation at 200Ω
- Ceramic Surface Mount Package (SMP)
- Small size

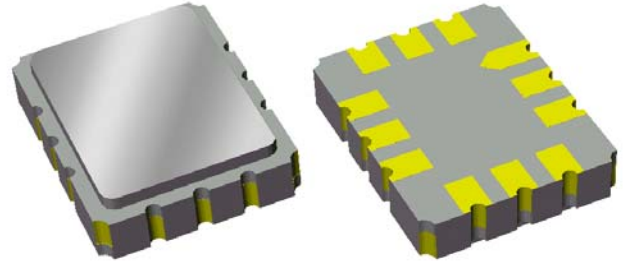

Package

Surface Mount 7.01 x 5.51 x 1.63 mm

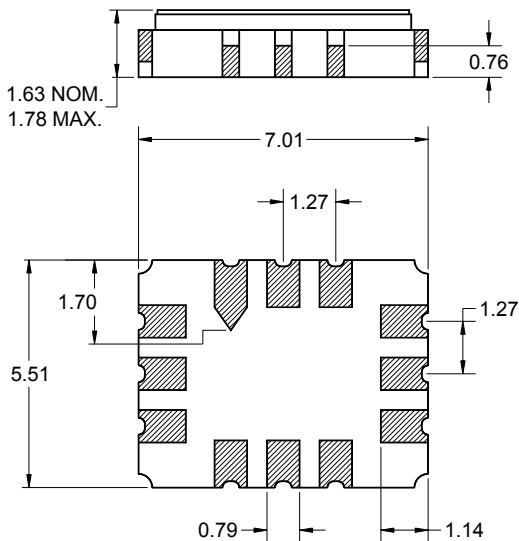

Dimensions shown are nominal in millimeters
 All tolerances are ± 0.15 mm except overall
 length and width ± 0.13 mm

Body: Al_2O_3 ceramic
 Lid: Kovar, Ni plated
 Terminations: Au plating 0.5 - 1.0 μ m,
 over a 2 - 6 μ m Ni plating

Pin Configuration

Bottom View

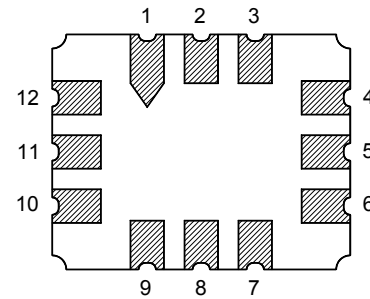

Pin No.	Description
4	Output
10	Input
1,2,3,5,6	Case Ground
7,8,9,11,12	Case Ground

Data Sheet

Electrical Specifications ⁽¹⁾

Temperature Range: ⁽²⁾ -40 to +85 °C

Parameter ⁽³⁾	Minimum	Typical	Maximum	Unit
Center Frequency (Fo)	-	398	-	MHz
Insertion Loss at Fo	-	12	15	dB
Lower 1 dB Bandedge ⁽⁴⁾	-	378.5	381	MHz
Upper 1 dB Bandedge	415	418.5	-	MHz
Amplitude Variation 382 - 414 MHz	-	0.7	1.1	dB p-p
Group Delay Ripple 382 - 414 MHz	-	40	80	ns p-p
Phase Ripple 382 - 414 MHz	-	0.8	1.5	deg RMS
Stopband Attenuation ⁽⁴⁾				
100 - 310 MHz	35	53	-	dB
310 - 340 MHz	40	56	-	dB
365 - 368 MHz	50	57	-	dB
470 - 1000 MHz	30	46	-	dB
1000 - 2000 MHz	30	48	-	dB
Source Impedance ⁽⁵⁾	-	200	-	Ω
Load Impedance ⁽⁵⁾	-	200	-	Ω

Notes:

1. All specifications are based on the test circuit shown below
2. In production, devices will be tested at room temperature to a guardbanded specification to ensure electrical compliance over temperature
3. Electrical margin has been built into the design to account for the variations due to temperature drift and manufacturing tolerances
4. Relative to insertion loss at 398.0 MHz
5. This is the optimum impedance in order to achieve the performance shown

Test Circuit:

Actual matching values may vary due to PCB layout and parasitics

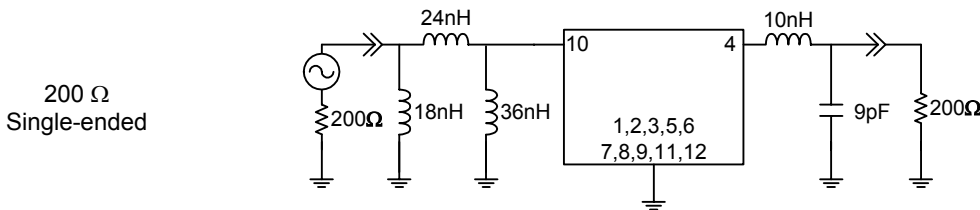

Data Sheet

Typical Performance (at +25°C)

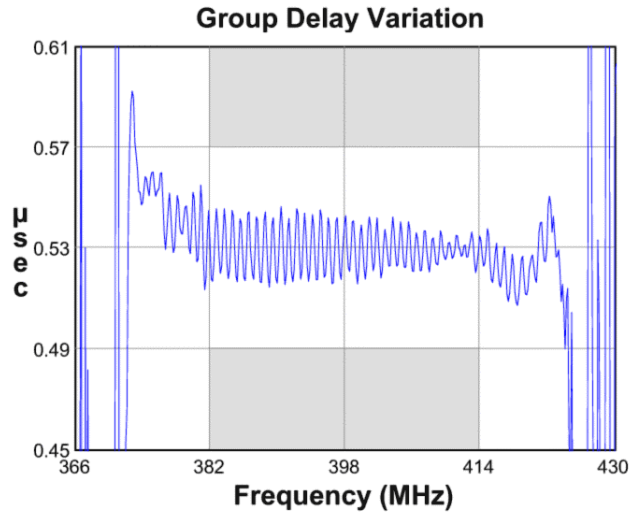
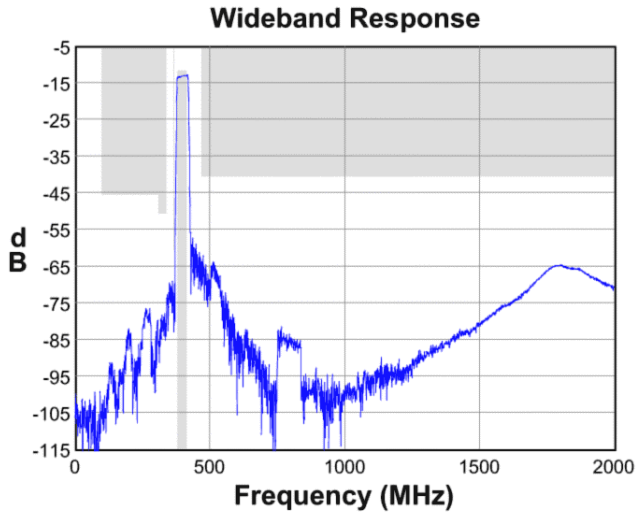
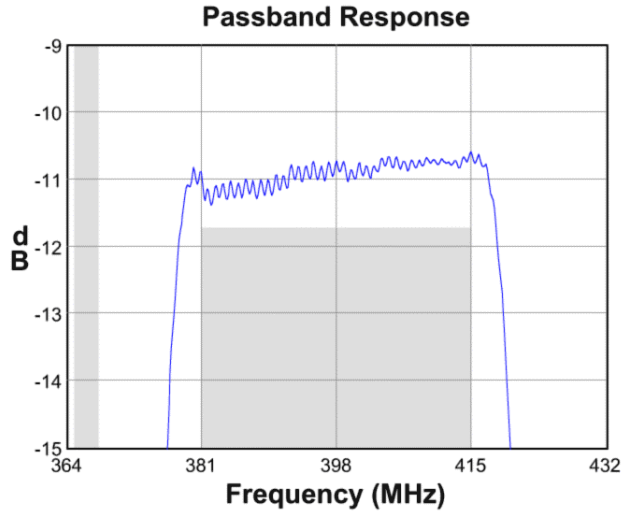
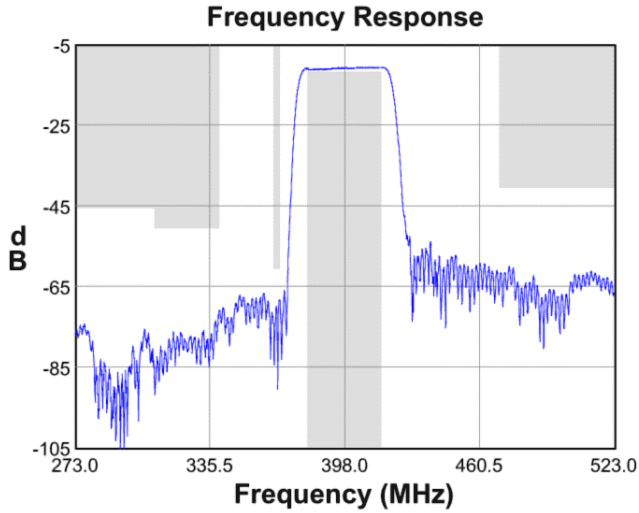

Input Smith Chart

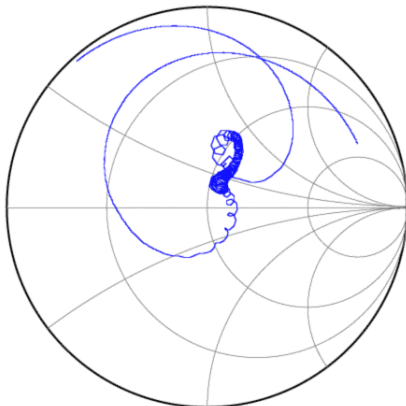

Output Smith Chart

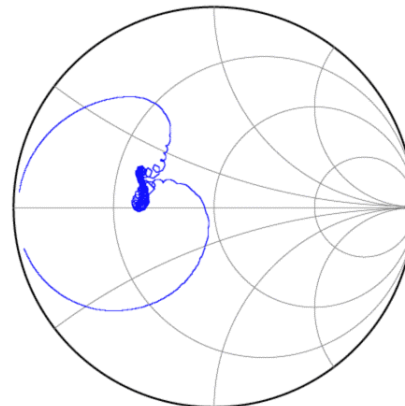

Data Sheet

Matching Schematics

Actual matching values may vary due to PCB layout and parasitics

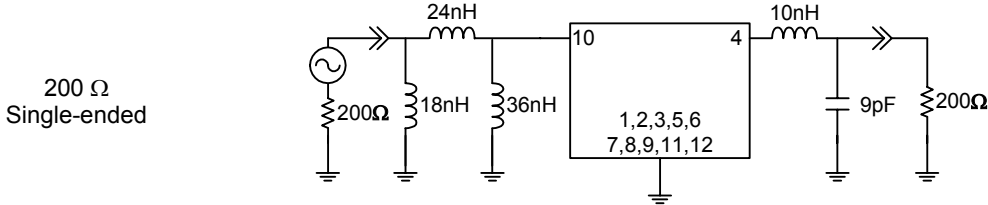

Marking



The date code consists of: day of the current year (Julian, 3 digits), last digit of the year (1 digit) and hour (2 digits)

PCB Footprint

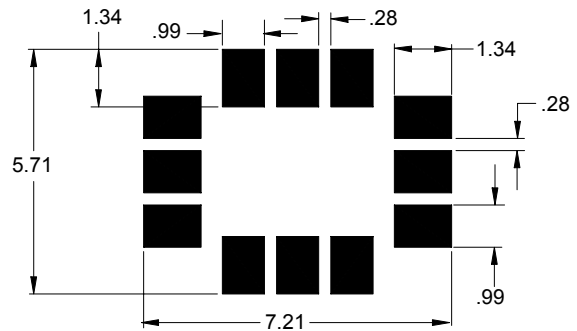

This footprint represents a recommendation only
Dimensions shown are nominal in millimeters

Tape and Reel

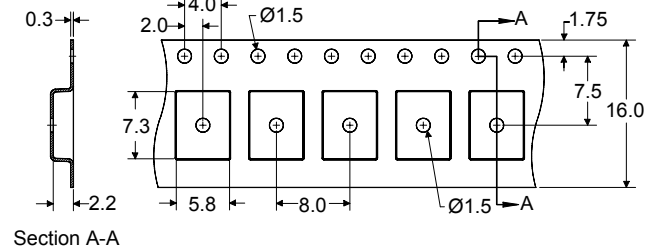
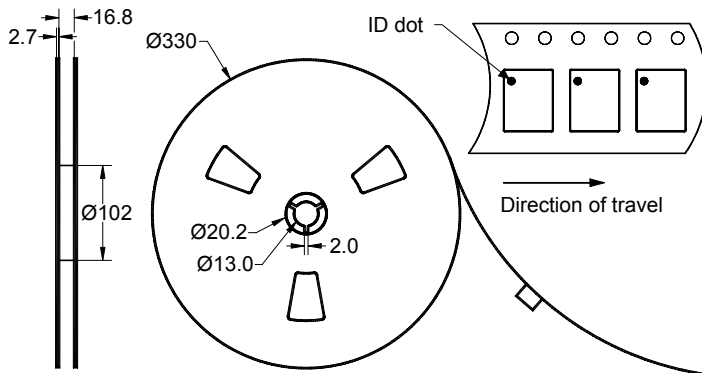

Dimensions shown are nominal in millimeters
Packaging quantity: 3000 units/reel

Data Sheet

Maximum Ratings

Parameter	Symbol	Minimum	Maximum	Unit
Operating Temperature Range	T	-40	+85	°C
Storage Temperature Range	T _{stg}	-40	+85	°C

Warnings

- Electrostatic Sensitive Device (ESD)
- Avoid ultrasonic exposure



Links to Additional Technical Information

[PCB Layout Tips](#)

[Qualification Flowchart](#)

[Soldering Profile](#)

[S-Parameters](#)

[Other Technical Information](#)

Sawtek's liability is limited only to the Surface Acoustic Wave (SAW) component(s) described in this data sheet. Sawtek does not accept any liability for applications, processes, circuits or assemblies which are implemented using any Sawtek component described in this data sheet.

Contact Information



PO Box 609501
 Orlando, FL 32860-9501
 USA

Phone: +1 (407) 886-8860
 Fax: +1 (407) 886-7061
 Email: custservice@sawtek.com
 Web: www.sawtek.com

Or contact one of our worldwide network of [sales offices](#), [representatives](#) or [distributors](#)