

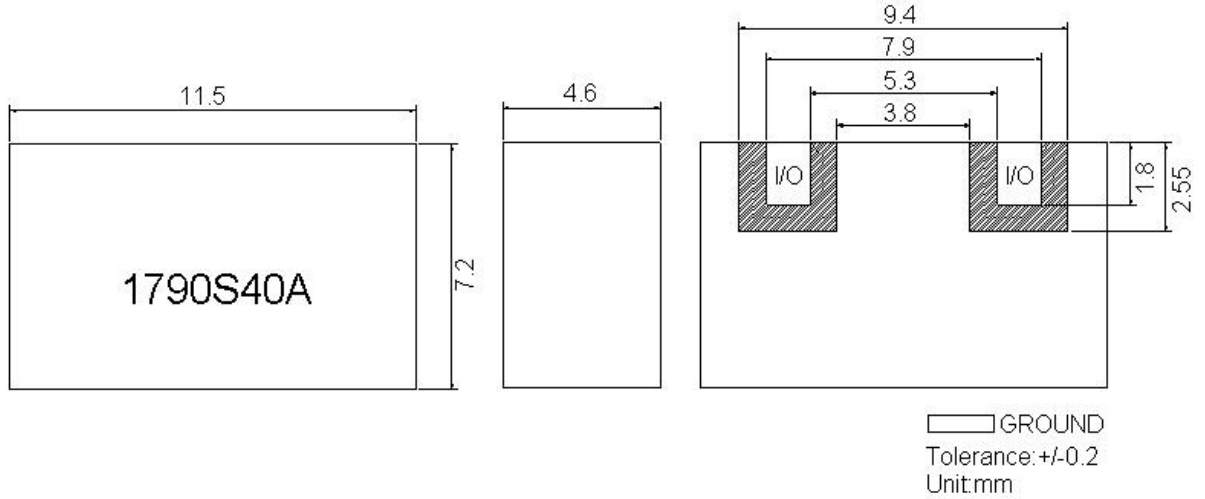

5. DIMENSIONS

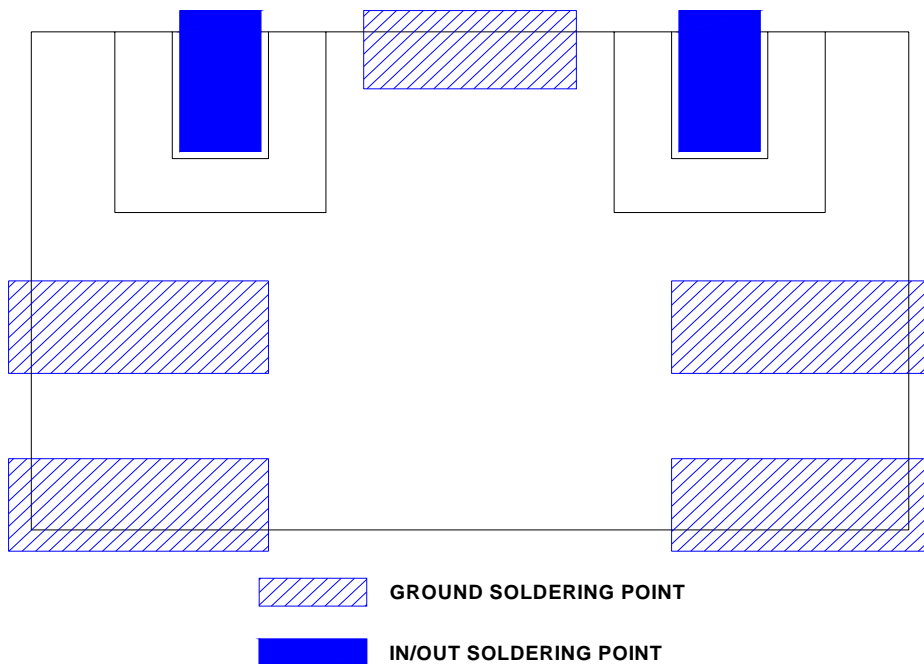

6. RECOMMENDED PC BOARD PATTERN



	SIPAT Co., Ltd. (CETC No. 26 Research Institute) Nanping Huayuan Road No. 14 Chongqing, China, 400060	Part Number	CMF4.53C1790S40A	
		Rev. Date	2005-9-15	
		Rev.	1.0	Page

7. CHARACTERISTICS

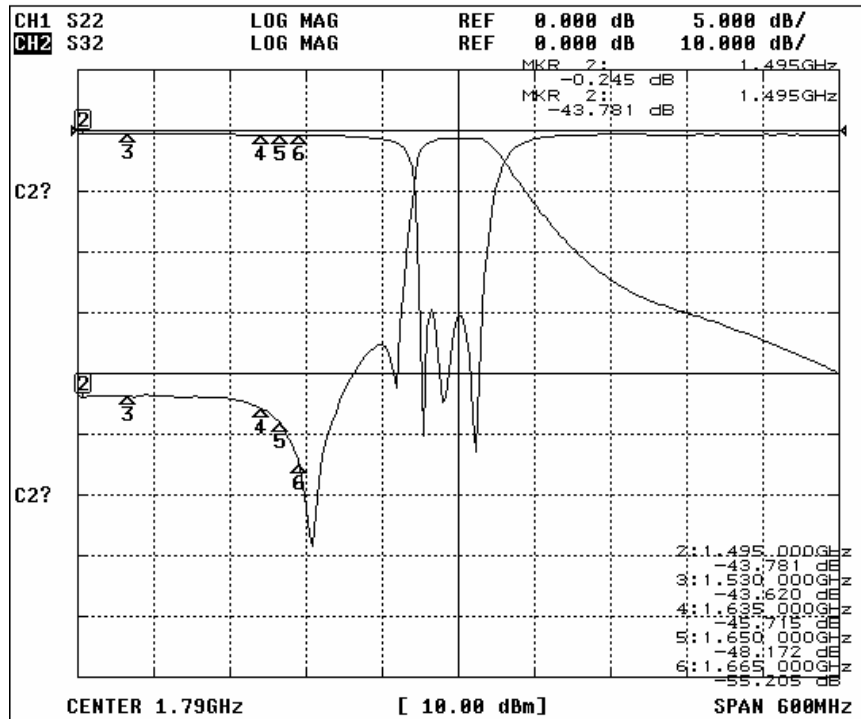
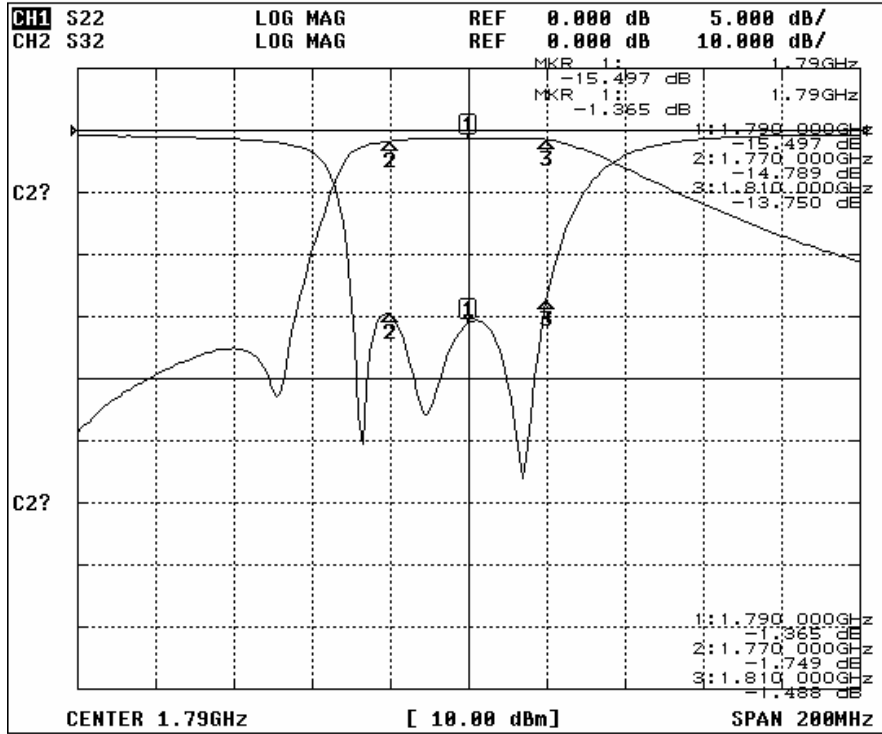

SIPAT Co., Ltd.
(CETC No. 26 Research Institute)
Nanping Huayuan Road No. 14
Chongqing, China, 400060

Part Number	CMF4.53C1790S40A	
Rev. Date	2005-9-15	
Rev.	1.0	Page 3/4

8. REFLOW SOLDERING STANDARD CONDITIONS

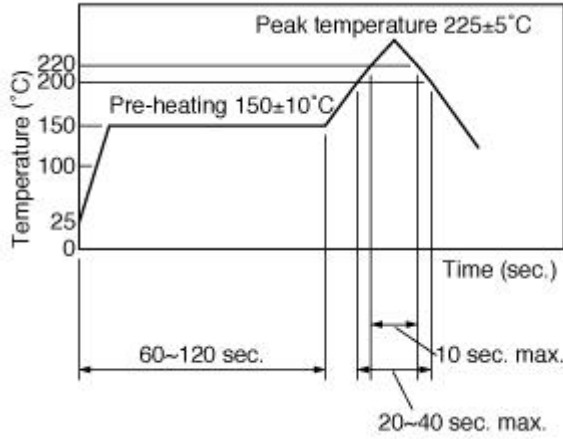

	SIPAT Co., Ltd. (CETC No. 26 Research Institute) Nanping Huayuan Road No. 14 Chongqing, China, 400060	Part Number	CMF4.53C1790S40A	
		Rev. Date	2005-9-15	
		Rev.	1.0	Page