

Technische Information / technical information

IGBT-Module
IGBT-Modules

FB10R06KL4GB1

eupec

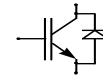

**Vorläufig
preliminary**

Elektrische Eigenschaften / electrical properties

Höchstzulässige Werte / maximum rated values

Diode Gleichrichter / diode rectifier

Periodische Rückw. Spitzensperrspannung repetitive peak reverse voltage	$T_{vj} = 25^{\circ}\text{C}$	V_{RRM}	800	V
Durchlaßstrom Grenzeffektivwert pro Chip RMS forward current per chip	$T_C = 80^{\circ}\text{C}$	I_{FRMSM}	23	A
Gleichrichter Ausgang Grenzeffektivstrom maximum RMS current at Rectifier output	$T_C = 80^{\circ}\text{C}$	I_{RMSmax}	25	A
Stoßstrom Grenzwert surge forward current	$t_p = 10 \text{ ms}, T_{vj} = 25^{\circ}\text{C}$	I_{FSM}	197	A
	$t_p = 10 \text{ ms}, T_{vj} = 150^{\circ}\text{C}$		158	A
Grenzlastintegral I^2t - value	$t_p = 10 \text{ ms}, T_{vj} = 25^{\circ}\text{C}$	I^2t	194	A^2s
	$t_p = 10 \text{ ms}, T_{vj} = 150^{\circ}\text{C}$		125	A^2s

Transistor Wechselrichter / transistor inverter

Kollektor-Emitter-Sperrspannung collector-emitter voltage	$T_{vj} = 25^{\circ}\text{C}$	V_{CES}	600	V
Kollektor-Dauergleichstrom DC-collector current	$T_C = 80^{\circ}\text{C}$	$I_{C,nom.}$	10	A
	$T_C = 25^{\circ}\text{C}$	I_C	15	A
Periodischer Kollektor Spitzenstrom repetitive peak collector current	$t_p = 1 \text{ ms}, T_C = 80^{\circ}\text{C}$	I_{CRM}	20	A
Gesamt-Verlustleistung total power dissipation	$T_C = 25^{\circ}\text{C}$	P_{tot}	55	W
Gate-Emitter-Spitzenspannung gate-emitter peak voltage		V_{GES}	+/- 20V	V

Diode Wechselrichter / diode inverter

Dauergleichstrom DC forward current		I_F	10	A
Periodischer Spitzenstrom repetitive peak forw. current	$t_p = 1 \text{ ms}$	I_{FRM}	20	A
Grenzlastintegral I^2t - value	$V_R = 0\text{V}, t_p = 10\text{ms}, T_{vj} = 125^{\circ}\text{C}$	I^2t	12	A^2s

Transistor Brems-Chopper / transistor brake-chopper

Kollektor-Emitter-Sperrspannung collector-emitter voltage	$T_{vj} = 25^{\circ}\text{C}$	V_{CES}	600	V
Kollektor-Dauergleichstrom DC-collector current	$T_C = 80^{\circ}\text{C}$	$I_{C,nom.}$	10	A
	$T_C = 25^{\circ}\text{C}$	I_C	15	A
Periodischer Kollektor Spitzenstrom repetitive peak collector current	$t_p = 1 \text{ ms}, T_C = 80^{\circ}\text{C}$	I_{CRM}	20	A
Gesamt-Verlustleistung total power dissipation	$T_C = 25^{\circ}\text{C}$	P_{tot}	55	W
Gate-Emitter-Spitzenspannung gate-emitter peak voltage		V_{GES}	+/- 20V	V

Diode Brems-Chopper / diode brake-chopper

Dauergleichstrom DC forward current		I_F	10	A
Periodischer Spitzenstrom repetitive peak forw. current	$t_p = 1 \text{ ms}$	I_{FRM}	20	A

prepared by: Thomas Passe	date of publication: 2003-03-26
approved by: R. Keggenhoff	revision: 2.1

Technische Information / technical information

IGBT-Module
IGBT-Modules

FB10R06KL4GB1

eupec

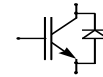

**Vorläufig
preliminary**

Modul Isolation / module isolation

Isolations-Prüfspannung insulation test voltage	RMS, f = 50 Hz, t = 1 min. NTC connected to baseplate	V _{ISOL}	2,5	kV
--	--	-------------------	-----	----

Elektrische Eigenschaften / electrical properties

Charakteristische Werte / characteristic values

Diode Gleichrichter / diode rectifier

			min.	typ.	max.	
Durchlaßspannung forward voltage	T _{vj} = 150°C, I _F = 10 A	V _F	-	0,9	-	V
Schleusenspannung threshold voltage	T _{vj} = 150°C	V _(TO)	-	0,67	-	V
Ersatzwiderstand slope resistance	T _{vj} = 150°C	r _T	-	21	-	mΩ
Sperrstrom reverse current	T _{vj} = 150°C, V _R = 800 V	I _R	-	5	-	mA
Modul Leitungswiderstand, Anschlüsse-Chip lead resistance, terminals-chip	T _C = 25°C	R _{AA+CC'}	-	11	-	mΩ

Transistor Wechselrichter / transistor inverter

			min.	typ.	max.	
Kollektor-Emitter Sättigungsspannung collector-emitter saturation voltage	V _{GE} = 15V, T _{vj} = 25°C, I _C = 10 A	V _{CE sat}	-	1,95	2,55	V
	V _{GE} = 15V, T _{vj} = 125°C, I _C = 10 A		-	2,2	-	V
Gate-Schwellenspannung gate threshold voltage	V _{CE} = V _{GE} , T _{vj} = 25°C, I _C = 0,35mA	V _{GE(TO)}	4,5	5,5	6,5	V
Eingangskapazität input capacitance	f = 1MHz, T _{vj} = 25°C V _{CE} = 25 V, V _{GE} = 0 V	C _{ies}	-	0,8	-	nF
Kollektor-Emitter Reststrom collector-emitter cut-off current	V _{GE} = 0V, T _{vj} = 25°C, V _{CE} = 600V	I _{CES}	-	-	5,0	mA
Gate-Emitter Reststrom gate-emitter leakage current	V _{CE} = 0V, V _{GE} = 20V, T _{vj} = 25°C	I _{GES}	-	-	400	nA
Einschaltverzögerungszeit (ind. Last) turn on delay time (inductive load)	I _C = I _{Nenn} , V _{CC} = 300 V	t _{d,on}	-	32	-	ns
	V _{GE} = ±15V, T _{vj} = 25°C, R _G = 82 Ohm					
	V _{GE} = ±15V, T _{vj} = 125°C, R _G = 82 Ohm					
Anstiegszeit (induktive Last) rise time (inductive load)	I _C = I _{Nenn} , V _{CC} = 300 V	t _r	-	26	-	ns
	V _{GE} = ±15V, T _{vj} = 25°C, R _G = 82 Ohm					
	V _{GE} = ±15V, T _{vj} = 125°C, R _G = 82 Ohm					
Abschaltverzögerungszeit (ind. Last) turn off delay time (inductive load)	I _C = I _{Nenn} , V _{CC} = 300 V	t _{d,off}	-	234	-	ns
	V _{GE} = ±15V, T _{vj} = 25°C, R _G = 82 Ohm					
	V _{GE} = ±15V, T _{vj} = 125°C, R _G = 82 Ohm					
Fallzeit (induktive Last) fall time (inductive load)	I _C = I _{Nenn} , V _{CC} = 300 V	t _f	-	10	-	ns
	V _{GE} = ±15V, T _{vj} = 25°C, R _G = 82 Ohm					
	V _{GE} = ±15V, T _{vj} = 125°C, R _G = 82 Ohm					
Einschaltverlustenergie pro Puls turn-on energy loss per pulse	I _C = I _{Nenn} , V _{CC} = 300 V V _{GE} = ±15V, T _{vj} = 125°C, R _G = 82 Ohm L _S = 80 nH	E _{on}	-	0,36	-	mJ
Abschaltverlustenergie pro Puls turn-off energy loss per pulse	I _C = I _{Nenn} , V _{CC} = 300 V V _{GE} = ±15V, T _{vj} = 125°C, R _G = 82 Ohm L _S = 80 nH	E _{off}	-	0,44	-	mJ
Kurzschlußverhalten SC Data	t _p ≤ 10μs, V _{GE} ≤ 15V, R _G = 82 Ohm T _{vj} ≤ 125°C, V _{CC} = 360 V di/dt = 400 A/μs	I _{SC}	-	40	-	A

Technische Information / technical information

IGBT-Module
IGBT-Modules

FB10R06KL4GB1

eupec

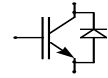

**Vorläufig
preliminary**

Elektrische Eigenschaften / electrical properties

Charakteristische Werte / characteristic values

				min.	typ.	max.	
Modulinduktivität stray inductance module		L_{GCE}	-	-	40	nH	
Modul Leitungswiderstand, Anschlüsse-Chip lead resistance, terminals-chip	$T_C = 25^\circ\text{C}$	$R_{\text{CC}'+\text{EE}'}$	-	10	-	m Ω	
Diode Wechselrichter / diode inverter				min.	typ.	max.	
Durchlaßspannung forward voltage	$V_{\text{GE}} = 0\text{V}, T_{\text{vj}} = 25^\circ\text{C}, I_{\text{F}} = 10\text{A}$ $V_{\text{GE}} = 0\text{V}, T_{\text{vj}} = 125^\circ\text{C}, I_{\text{F}} = 10\text{A}$	V_{F}	-	1,85	2,25	V	
Rückstromspitze peak reverse recovery current	$I_{\text{F}} = I_{\text{Nenn}}, -di_{\text{F}}/dt = 600\text{A/us}$ $V_{\text{GE}} = -10\text{V}, T_{\text{vj}} = 25^\circ\text{C}, V_{\text{R}} = 300\text{V}$ $V_{\text{GE}} = -10\text{V}, T_{\text{vj}} = 125^\circ\text{C}, V_{\text{R}} = 300\text{V}$	I_{RM}	-	11	-	A	
Sperrverzögerungsladung recovered charge	$I_{\text{F}} = I_{\text{Nenn}}, -di_{\text{F}}/dt = 600\text{A/us}$ $V_{\text{GE}} = -10\text{V}, T_{\text{vj}} = 25^\circ\text{C}, V_{\text{R}} = 300\text{V}$ $V_{\text{GE}} = -10\text{V}, T_{\text{vj}} = 125^\circ\text{C}, V_{\text{R}} = 300\text{V}$	Q_{r}	-	0,35	-	μAs	
Abschaltenergie pro Puls reverse recovery energy	$I_{\text{F}} = I_{\text{Nenn}}, -di_{\text{F}}/dt = 600\text{A/us}$ $V_{\text{GE}} = -10\text{V}, T_{\text{vj}} = 25^\circ\text{C}, V_{\text{R}} = 300\text{V}$ $V_{\text{GE}} = -10\text{V}, T_{\text{vj}} = 125^\circ\text{C}, V_{\text{R}} = 300\text{V}$	E_{rec}	-	0,05	-	mJ	
Transistor Brems-Chopper / transistor brake-chopper				min.	typ.	max.	
Kollektor-Emitter Sättigungsspannung collector-emitter saturation voltage	$V_{\text{GE}} = 15\text{V}, T_{\text{vj}} = 25^\circ\text{C}, I_{\text{C}} = 10,0\text{A}$ $V_{\text{GE}} = 15\text{V}, T_{\text{vj}} = 125^\circ\text{C}, I_{\text{C}} = 10,0\text{A}$	$V_{\text{CE sat}}$	-	1,95	2,55	V	
Gate-Schwellenspannung gate threshold voltage	$V_{\text{CE}} = V_{\text{GE}}, T_{\text{vj}} = 25^\circ\text{C}, I_{\text{C}} = 0,35\text{mA}$	$V_{\text{GE(TO)}}$	4,5	5,5	6,5	V	
Eingangskapazität input capacitance	$f = 1\text{MHz}, T_{\text{vj}} = 25^\circ\text{C}$ $V_{\text{CE}} = 25\text{V}, V_{\text{GE}} = 0\text{V}$	C_{ies}	-	0,8	-	nF	
Kollektor-Emitter Reststrom collector-emitter cut-off current	$V_{\text{GE}} = 0\text{V}, T_{\text{vj}} = 25^\circ\text{C}, V_{\text{CE}} = 600\text{V}$		-	-	5,0	mA	
Gate-Emitter Reststrom gate-emitter leakage current	$V_{\text{CE}} = 0\text{V}, V_{\text{GE}} = 20\text{V}, T_{\text{vj}} = 25^\circ\text{C}$	I_{GES}	-	-	400	nA	
Diode Brems-Chopper / diode brake-chopper				min.	typ.	max.	
Durchlaßspannung forward voltage	$T_{\text{vj}} = 25^\circ\text{C}, I_{\text{F}} = 10,0\text{A}$ $T_{\text{vj}} = 125^\circ\text{C}, I_{\text{F}} = 10,0\text{A}$	V_{F}	-	1,85	2,25	V	
NTC-Widerstand / NTC-thermistor				min.	typ.	max.	
Nennwiderstand rated resistance	$T_C = 25^\circ\text{C}$	R_{25}	-	5	-	k Ω	
Abweichung von R_{100} deviation of R_{100}	$T_C = 100^\circ\text{C}, R_{100} = 493\ \Omega$	$\Delta R/R$	-5		5	%	
Verlustleistung power dissipation	$T_C = 25^\circ\text{C}$	P_{25}			20	mW	
B-Wert B-value	$R_2 = R_1 \exp [B(1/T_2 - 1/T_1)]$	$B_{25/50}$		3375		K	

Technische Information / technical information

IGBT-Module
IGBT-Modules

FB10R06KL4GB1

eupec

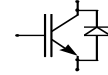

**Vorläufig
preliminary**

Thermische Eigenschaften / thermal properties

		min.	typ.	max.		
Innerer Wärmewiderstand thermal resistance, junction to heatsink	Gleichr. Diode/ rectif. diode $\lambda_{\text{Paste}}=1\text{W/m}^2\text{K}$	R_{thJH}	-	2,6	-	K/W
	Trans. Wechselr./ trans. inverter $\lambda_{\text{grease}}=1\text{W/m}^2\text{K}$		-	2,8	-	K/W
	Diode Wechselr./ diode inverter		-	4,3	-	K/W
	Trans. Bremse/ trans. brake		-	2,8	-	K/W
	Diode Bremse/ diode brake		-	4,3	-	K/W
Innerer Wärmewiderstand thermal resistance, junction to case	Gleichr. Diode/ rectif. diode	R_{thJC}	-	-	2,4	K/W
	Trans. Wechselr./ trans.inverter		-	-	2,2	K/W
	Diode Wechselr./ diode inverter		-	-	3,1	K/W
	Trans. Bremse/ trans. brake		-	-	2,2	K/W
	Diode Bremse/ diode brake		-	-	3,1	K/W
Übergangs-Wärmewiderstand thermal resistance, case to heatsink	Gleichr. Diode/ rectif. diode $\lambda_{\text{Paste}}=1\text{W/m}^2\text{K}$	R_{thCH}	-	0,4	-	K/W
	Trans. Wechselr./ trans. inverter $\lambda_{\text{grease}}=1\text{W/m}^2\text{K}$		-	0,8	-	K/W
	Diode Wechselr./ diode inverter		-	1,5	-	K/W
	Trans. Bremse/ trans. brake		-	0,8	-	K/W
	Diode Bremse/ diode brake		-	1,5	-	K/W
Höchstzulässige Sperrschichttemperatur maximum junction temperature		T_{vj}	-	-	150	°C
Betriebstemperatur operation temperature		T_{op}	-40	-	125	°C
Lagertemperatur storage temperature		T_{stg}	-40	-	125	°C

Mechanische Eigenschaften / mechanical properties

Innere Isolation internal insulation			Al_2O_3	
CTI comperative tracking index			225	
Anpreßkraft f. mech. Befestigung pro Feder mounting force per clamp		F	40...80	N
Gewicht weight		G	36	g
Kontakt - Kühlkörper terminal to heatsink	Kriechstrecke creepage distance		13,5	mm
	Luftstrecke clearance distance		12	mm
Terminal - Terminal terminal to terminal	Kriechstrecke creepage distance		7,5	mm
	Luftstrecke clearance distance		7,5	mm

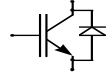

Vorläufig
preliminary

Ausgangskennlinienfeld Wechselr. (typisch) $I_C = f(V_{CE})$
output characteristic inverter (typical) $V_{GE} = 15\text{ V}$

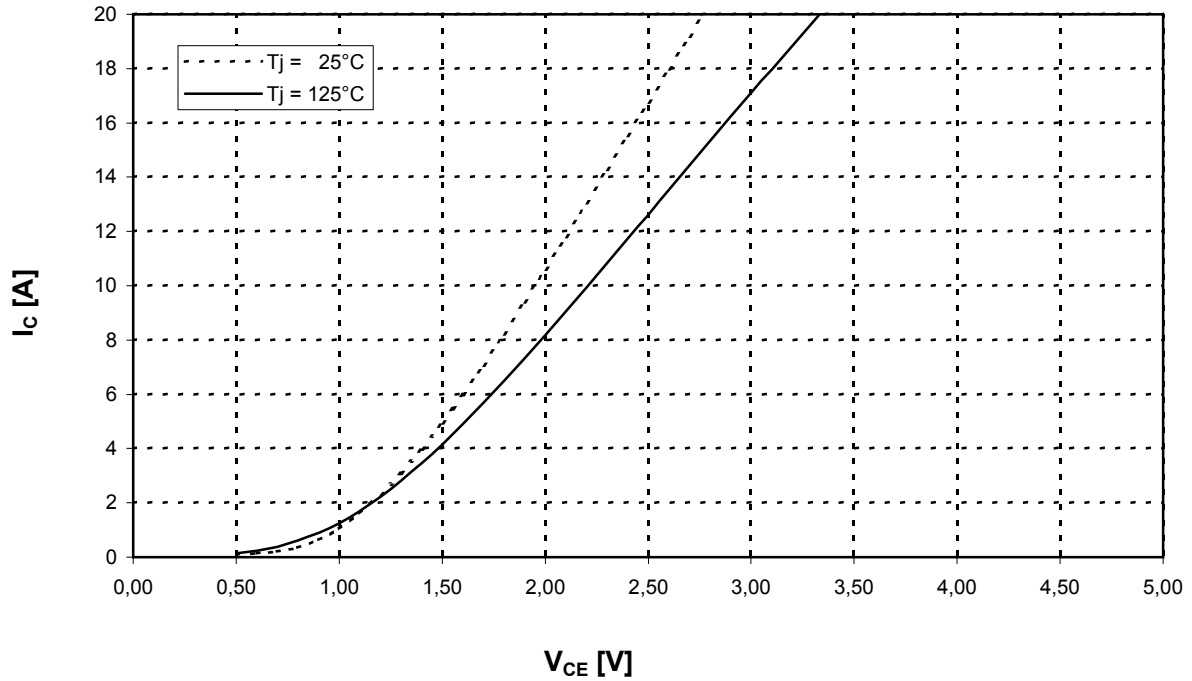

Ausgangskennlinienfeld Wechselr. (typisch) $I_C = f(V_{CE})$
output characteristic inverter (typical) $T_{vj} = 125^\circ\text{C}$

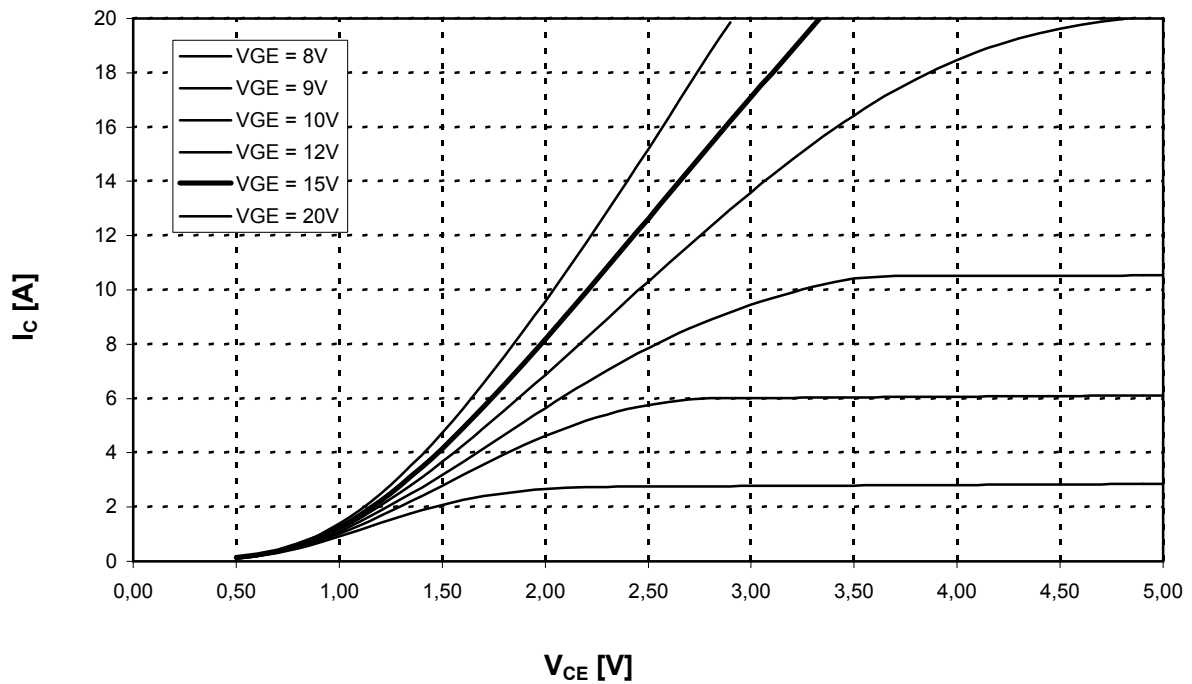

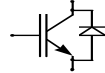

Vorläufig
preliminary

Übertragungscharakteristik Wechselr. (typisch)

$I_C = f(V_{GE})$

transfer characteristic inverter (typical)

$V_{CE} = 20\text{ V}$

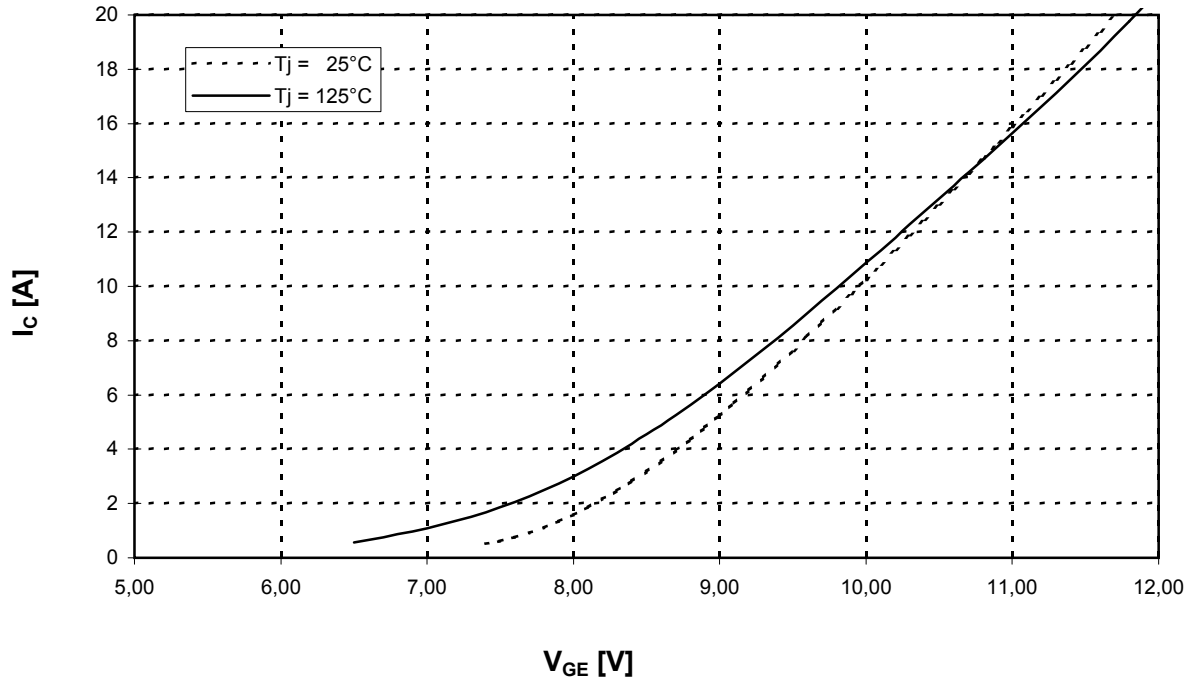

Durchlaßkennlinie der Freilaufdiode Wechselr. (typisch)

$I_F = f(V_F)$

forward characteristic of FWD inverter (typical)

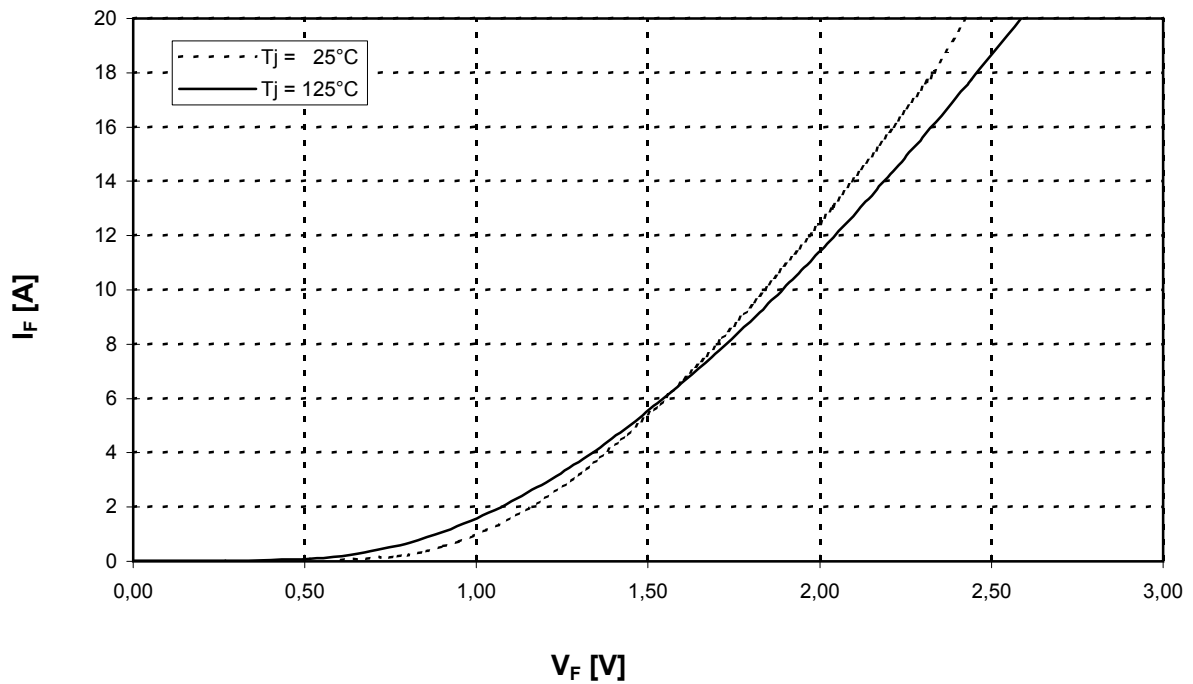

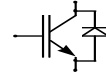

Vorläufig
preliminary

Schaltverluste Wechselr. (typisch) $E_{on} = f(I_c)$, $E_{off} = f(I_c)$, $E_{rec} = f(I_c)$ $V_{CC} = 300\text{ V}$
 switching losses inverter (typical) $T_j = 125^\circ\text{C}$, $V_{GE} = \pm 15\text{ V}$, $R_{Gon} = R_{Goff} = 82\text{ Ohm}$

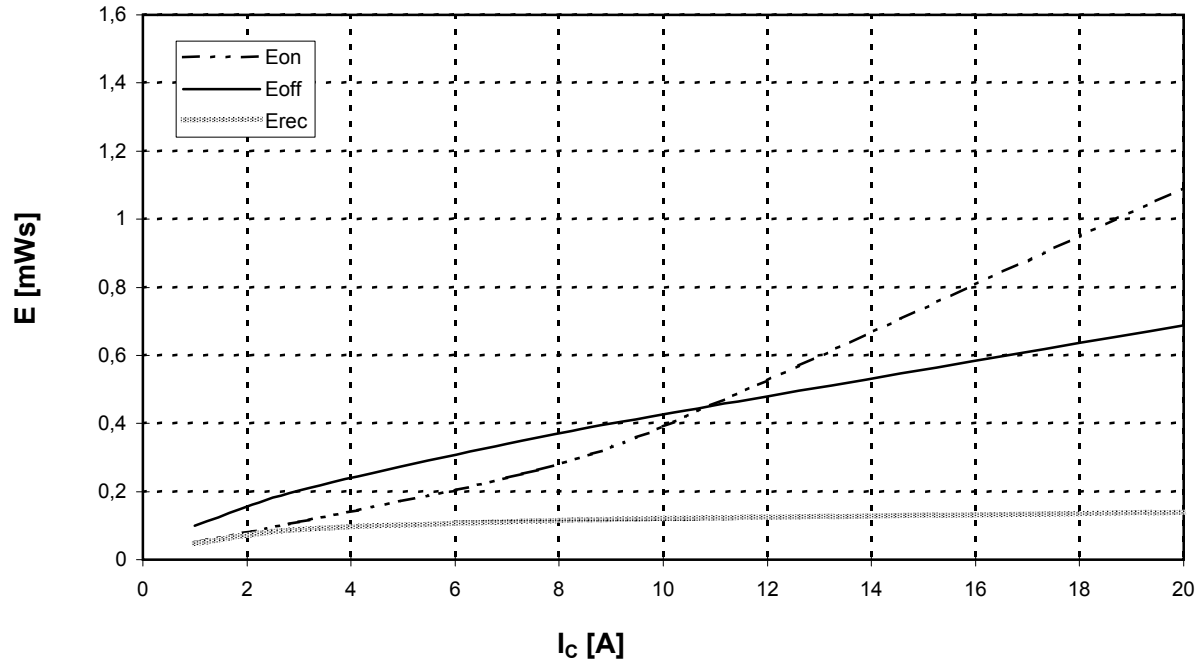

Schaltverluste Wechselr. (typisch) $E_{on} = f(R_G)$, $E_{off} = f(R_G)$, $E_{rec} = f(R_G)$
 switching losses inverter (typical) $T_j = 125^\circ\text{C}$, $V_{GE} = +15\text{ V}$, $I_c = I_{nenn}$, $V_{CC} = 300\text{ V}$

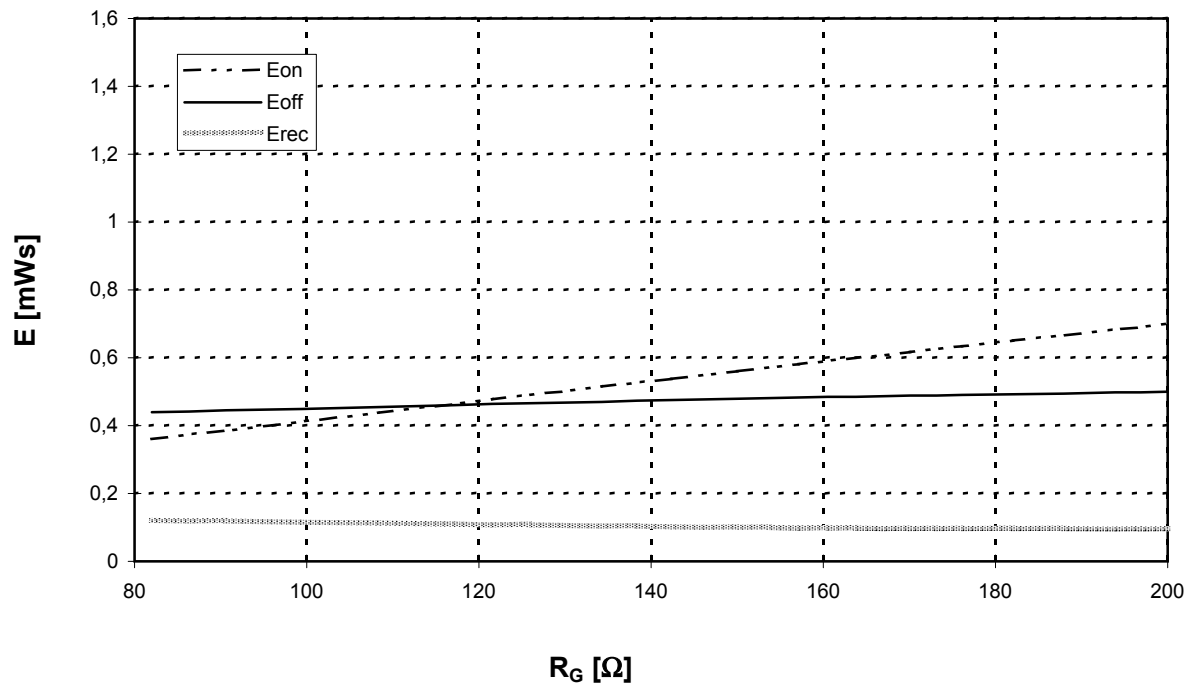

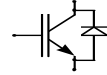

Vorläufig
preliminary

Transienter Wärmewiderstand Wechsele
transient thermal impedance inverter $Z_{thJH} = f(t)$

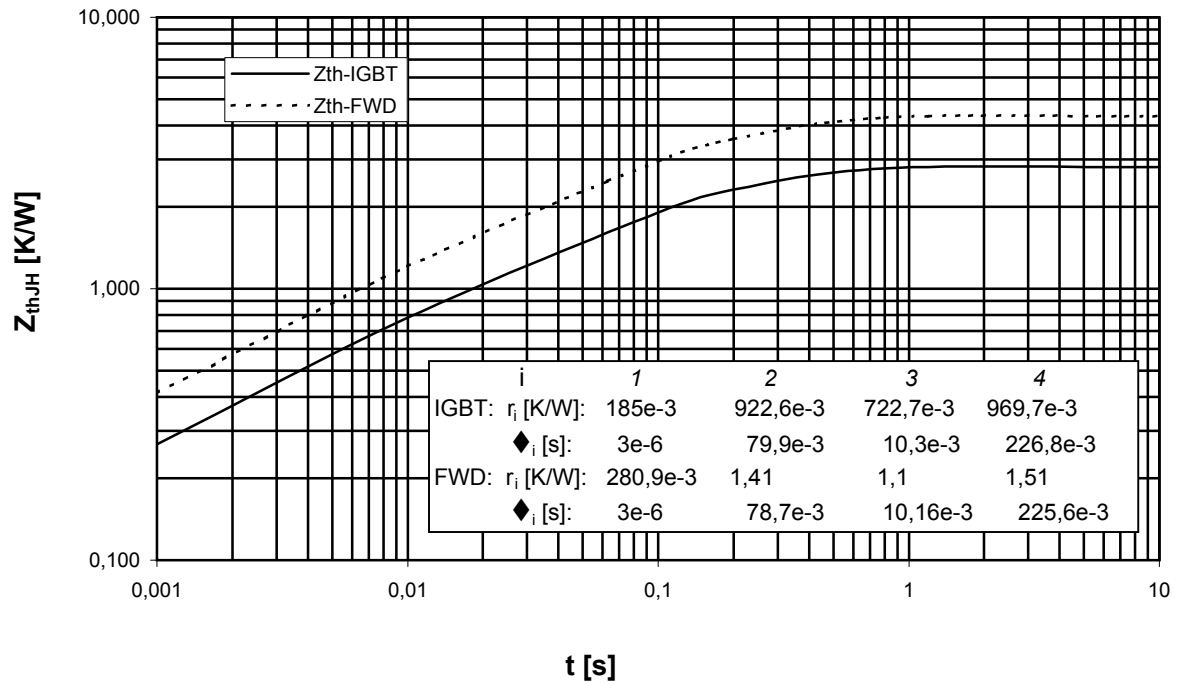

Sicherer Arbeitsbereich Wechsele (RBSOA) $I_C = f(V_{CE})$
reverse bias safe operating area inverter (RBSOA) $T_{vj} = 125^\circ\text{C}$, $V_{GE} = \pm 15\text{V}$, $R_G = 82 \text{ Ohm}$

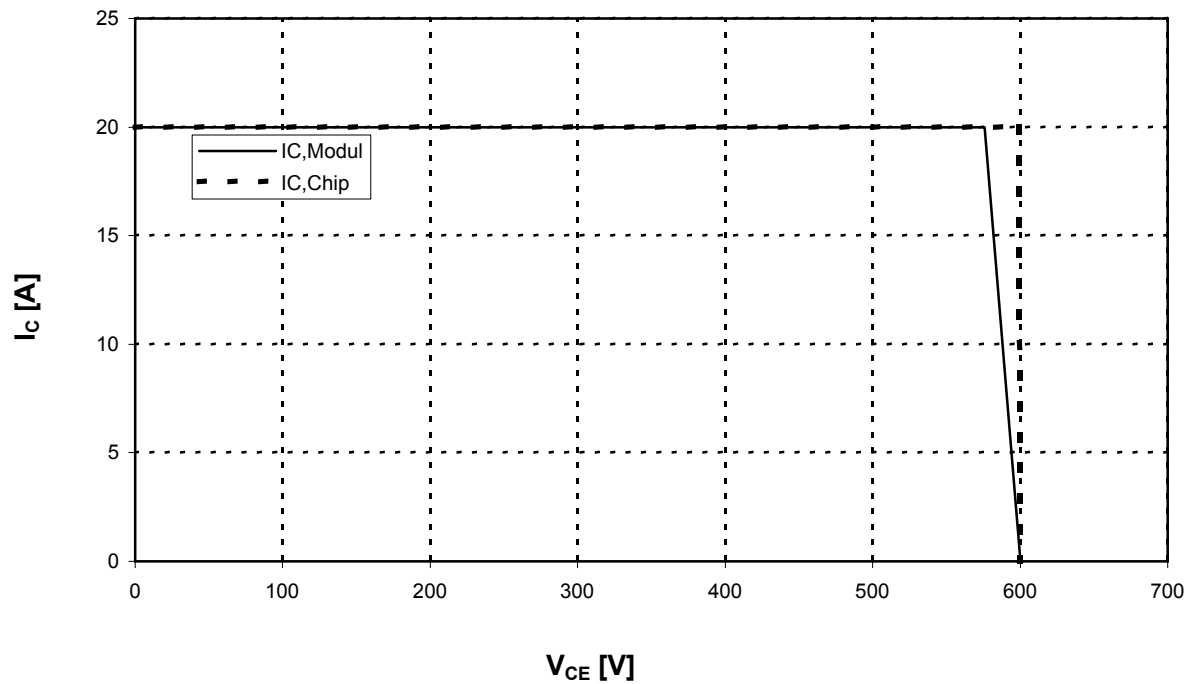

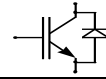

Vorläufig
preliminary

Ausgangskennlinienfeld Brems-Chopper-IGBT (typisch)
output characteristic brake-chopper-IGBT (typical)

$I_C = f(V_{CE})$
 $V_{GE} = 15\text{ V}$

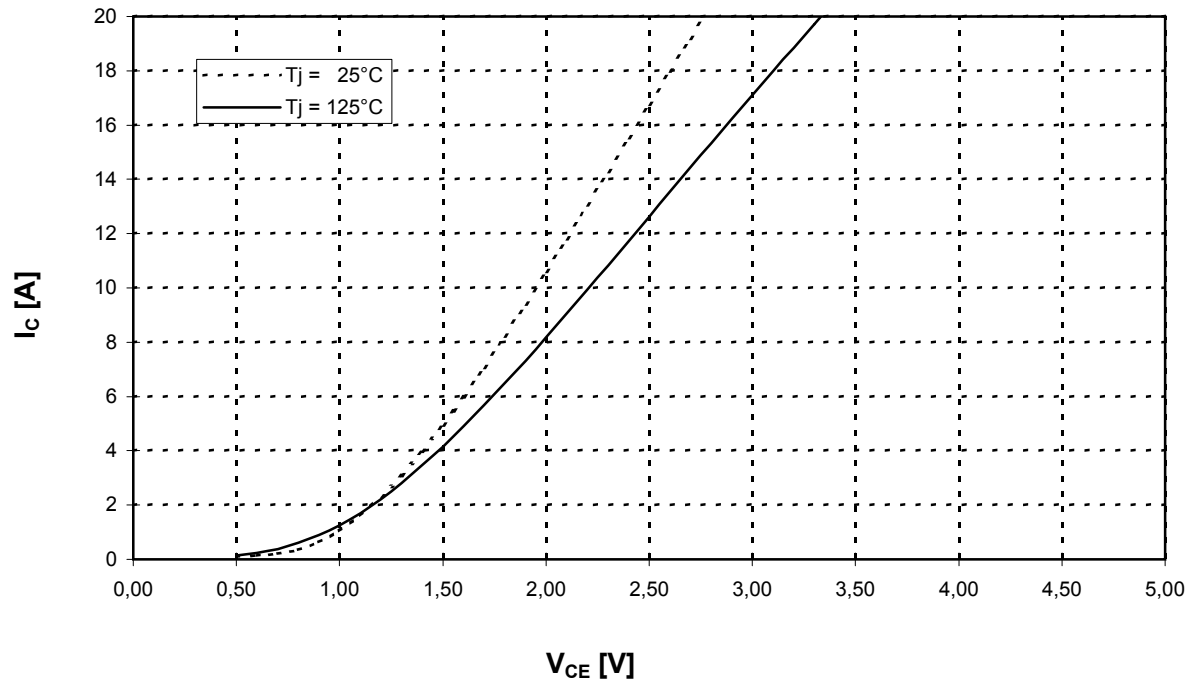

Durchlaßkennlinie der Brems-Chopper-Diode (typisch) $I_F = f(V_F)$
forward characteristic of brake-chopper-FWD (typical)

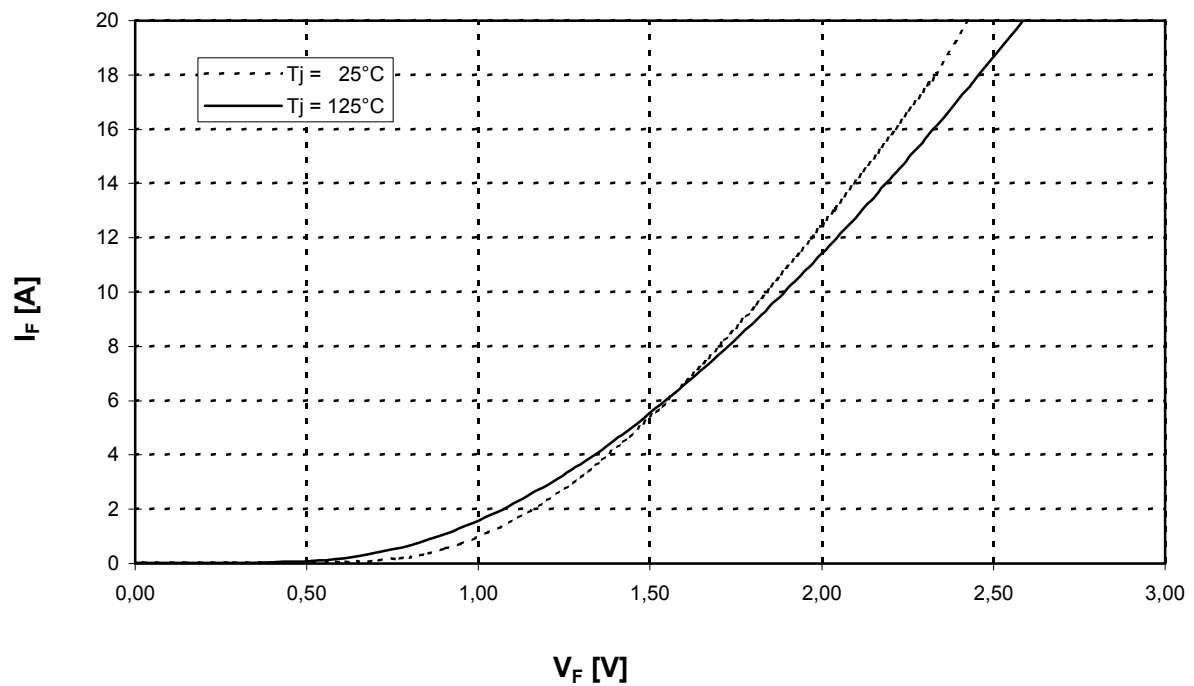

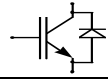

Vorläufig
preliminary

Durchlaßkennlinie der Gleichrichterdiode (typisch) $I_F = f(V_F)$
forward characteristic of rectifier diode (typical)

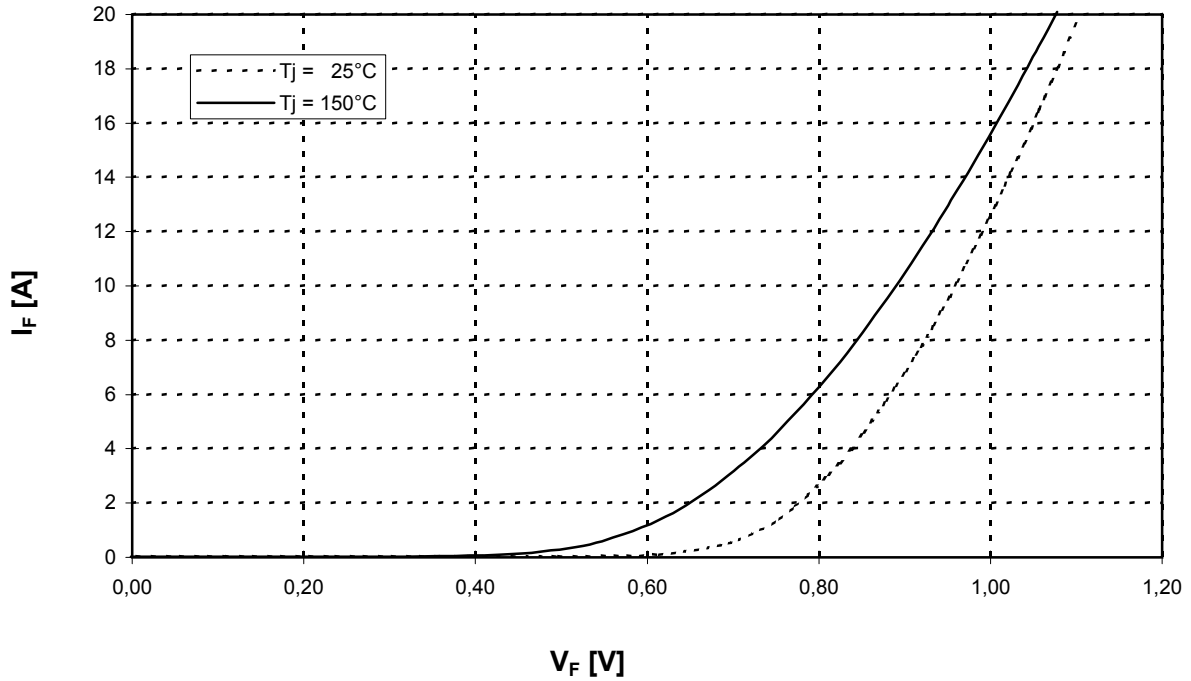

NTC- Temperaturkennlinie (typisch) $R = f(T)$
NTC- temperature characteristic (typical)

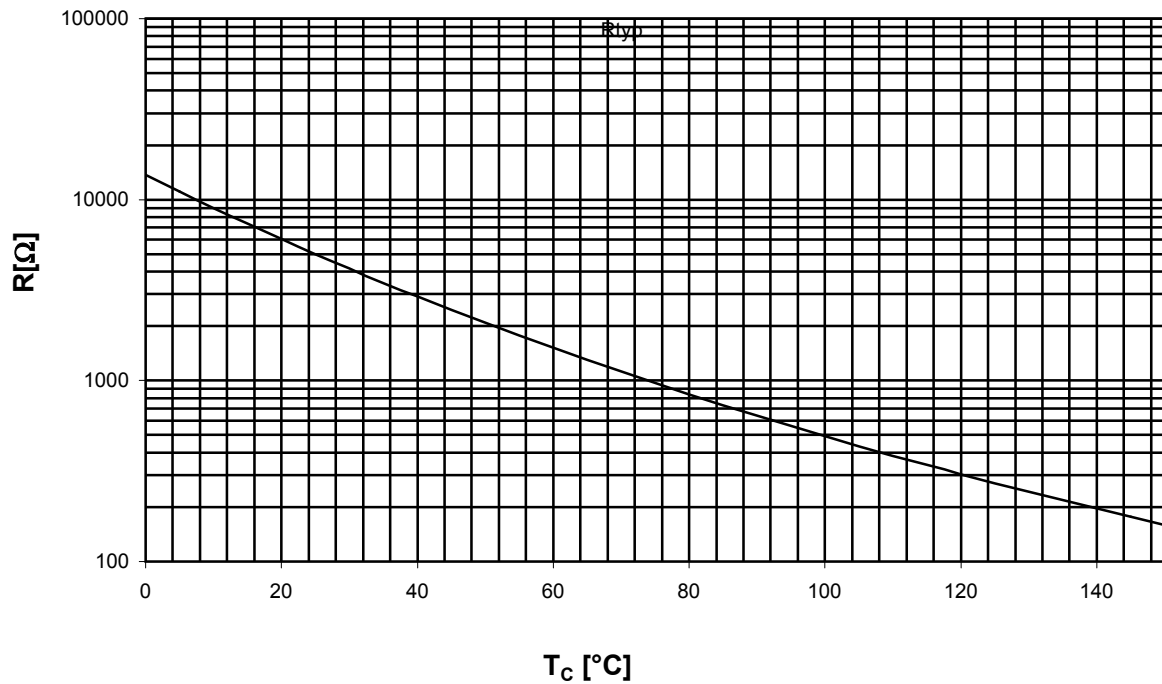

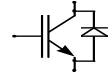

Vorläufig
preliminary

Schaltplan/ circuit diagram

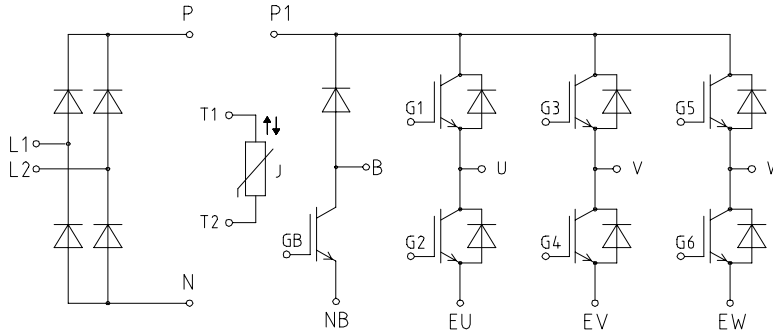

Gehäuseabmessungen/ package outlines

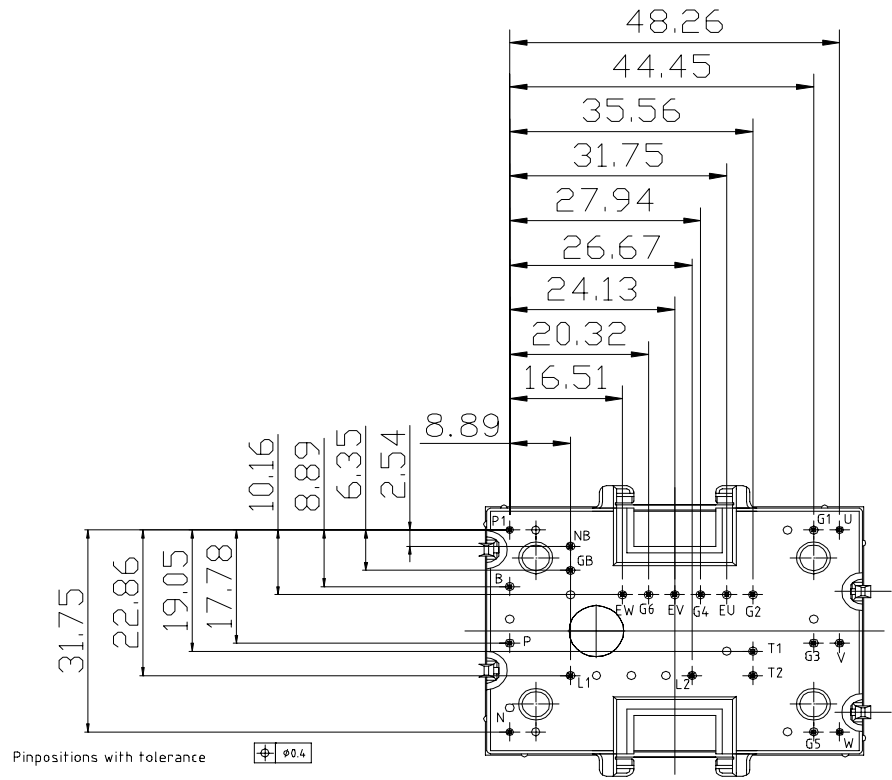

Bohrplan /
drilling layout

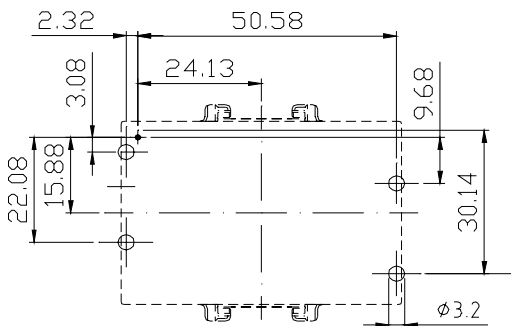

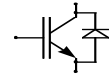

Gehäuseabmessungen Forts. / package outlines contd.

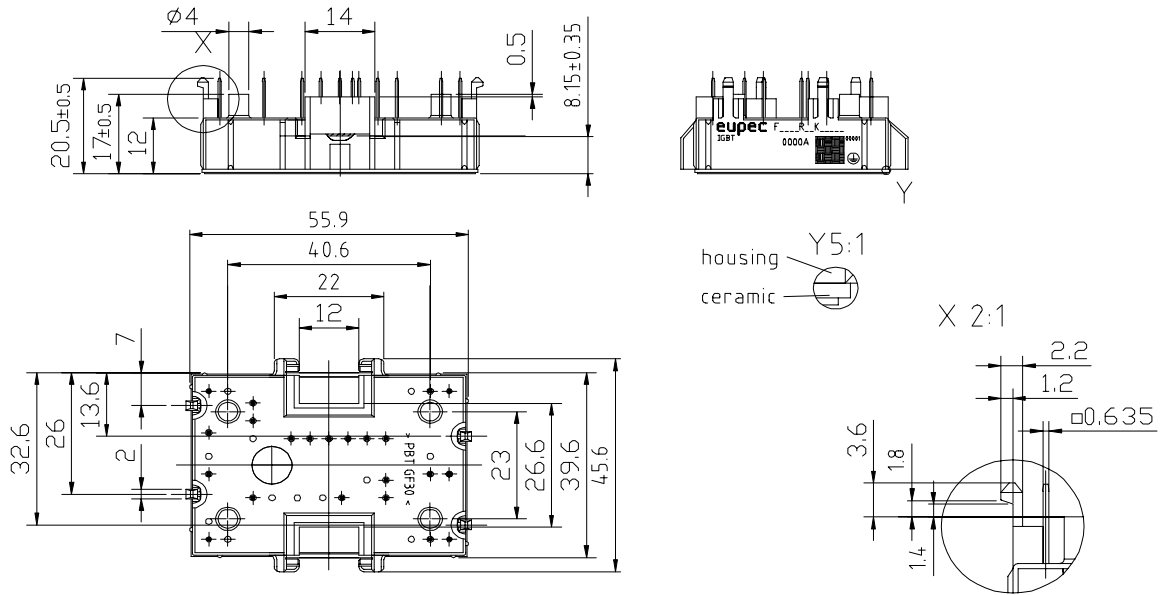

Mit dieser technischen Information werden Halbleiterbauelemente spezifiziert, jedoch keine Eigenschaften zugesichert. Sie gilt in Verbindung mit den zugehörigen technischen Erläuterungen.

This technical information specifies semiconductor devices but promises no characteristics. It is valid in combination with the belonging technical note:

Terms & Conditions of Usage

Attention

The present product data is exclusively subscribed to technically experienced staff. This Data Sheet is describing the specification of the products for which a warranty is granted exclusively pursuant the terms and conditions of the supply agreement. There will be no guarantee of any kind for the product and its specifications. Changes to the Data Sheet are reserved.

You and your technical departments will have to evaluate the suitability of the product for the intended application and the completeness of the product data with respect to such application. Should you require product information in excess of the data given in the Data Sheet, please contact your local Sales Office via "www.eupec.com / sales & contact".

Warning

Due to technical requirements the products may contain dangerous substances. For information on the types in question please contact your local Sales Office via "www.eupec.com / sales & contact".