

SOT-23

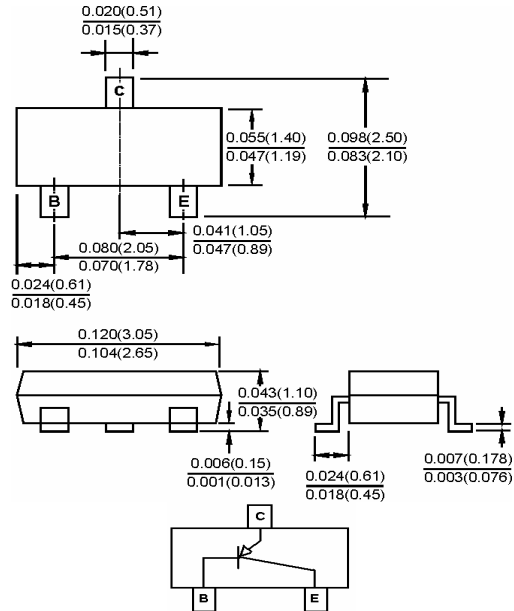

Features

- ◇ As complementary type, the NPN transistor MMBT3904 is recommended
- ◇ Epitaxial planar die construction
- ◇ Marking: 2A



Dimensions in inches and (millimeters)

Maximum Ratings $T_A=25^\circ\text{C}$ unless otherwise specified

Type Number	Symbol	Value	Units
Collector-base voltage	V_{CB0}	-40	V
Collector-emitter voltage	V_{CEO}	-40	V
Emitter-base voltage	V_{EBO}	-5	V
Collector current - continuous	I_C	-0.2	A
Collector Power dissipation	P_C	0.3	W

ELECTRICAL CHARACTERISTICS

Parameter	Symbol	MIN	MAX	Units
Collector-base breakdown voltage $I_C=-10\mu\text{A}, I_E=0$	$V_{(BR)CBO}$	-40		V
Collector-emitter breakdown voltage $I_C=-1\text{mA}, I_B=0$	$V_{(BR)CEO}$	-40		V
Emitter-base breakdown voltage $I_E=-10\mu\text{A}, I_C=0$	$V_{BE(ON)}$	-5		V
Collector cut-off current $V_{CB}=-40\text{V}, I_E=0$	I_{CBO}		-0.1	μA
Collector cur-off current $V_{CE}=-30\text{V}, V_{BE}(\text{off})=-3\text{V}$	I_{CEX}		-50	nA
Emitter cut-off current $V_{EB}=-5\text{V}, I_C=0$	I_{EBO}		-0.1	
DC current gain	$V_{CE}=-1\text{V}, I_C=-10\text{mA}$	$h_{FE(1)}$	100	300
	$V_{CE}=-1\text{V}, I_C=-50\text{mA}$	$h_{FE(2)}$	60	
	$V_{CE}=-1\text{V}, I_C=-100\text{mA}$	$h_{FE(3)}$	30	
Collector-emitter saturation voltage $I_C=-50\text{mA}, I_B=-5\text{mA}$	$V_{CE(\text{sat})}$		-0.4	V
Base-emitter saturation voltage $I_C=-50\text{mA}, I_B=-5\text{mA}$	$V_{BE(\text{sat})}$		-0.95	V
Transition frequency $V_{CE}=-20\text{V}, I_C=-10\text{mA}, f=100\text{MHz}$	f_T	250		MHz
Delay time $V_{CC}=-3\text{V}, V_{BE}=-0.5\text{V}, I_C=-10\text{mA}$	t_d		35	nS
Rise time $I_{B1}=-1.0\text{mA}$	t_r		35	nS
Storage time $V_{CC}=-3\text{V}, I_C=-10\text{mA}$	t_s		225	nS
Fall time $I_{B1}=I_{B2}=-1.0\text{mA}$	t_f		75	nS
Operating and Storage Temperature Range	T_J, T_{STG}	-55 to +150		$^\circ\text{C}$

CLASSIFICATION OF h_{FE1}

Rank	O	Y
Range	100-200	200-300

RATINGS AND CHARACTERISTIC CURVES (MMBT3906)

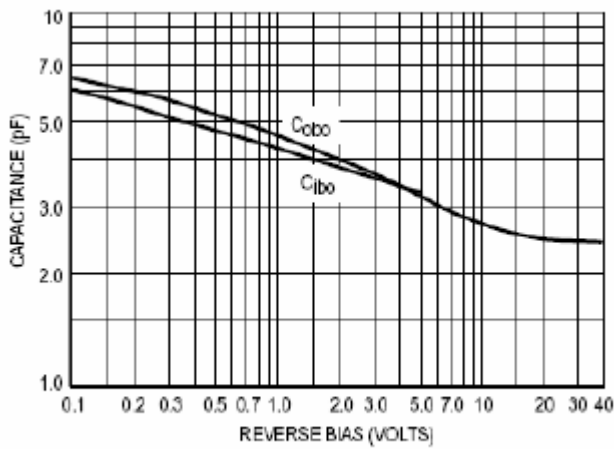

Figure 1 Capacitance

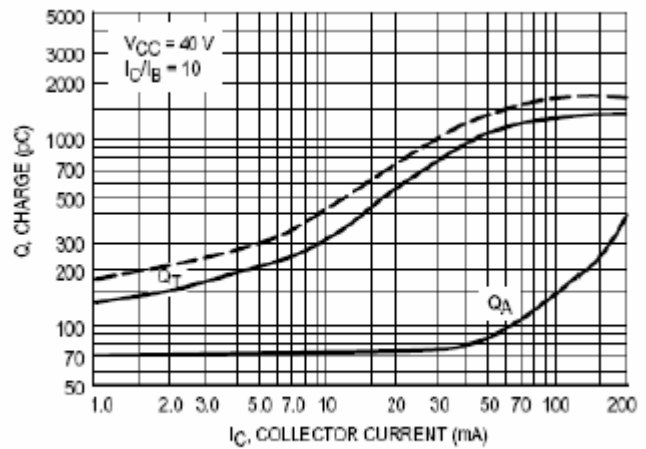

Figure 2 Charge Data

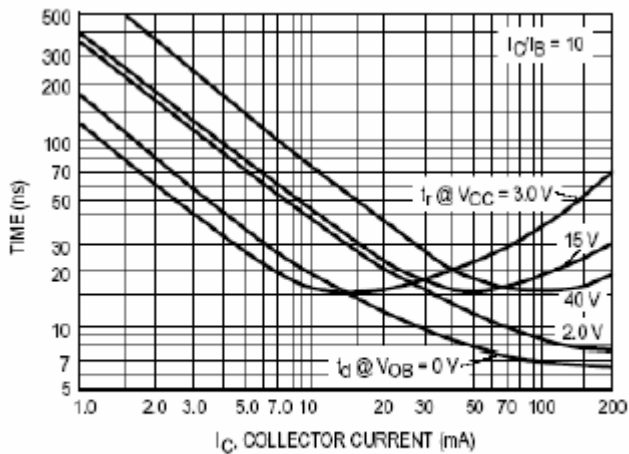

Figure 3 Turn-On Time

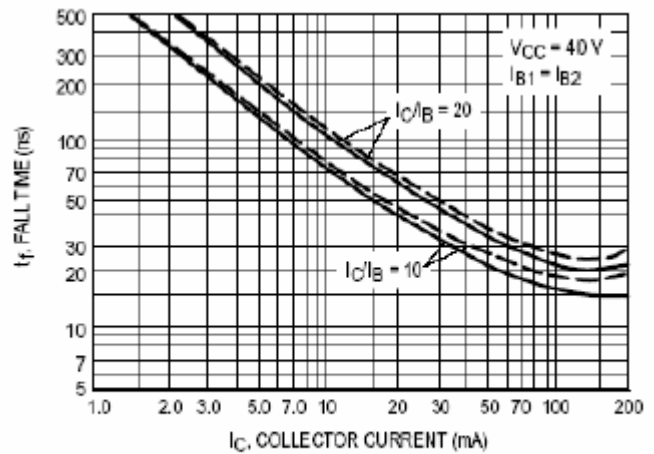

Figure 4 Fall Time

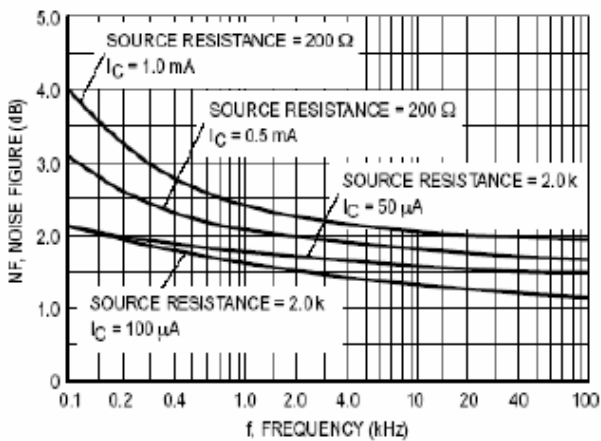

Figure 5

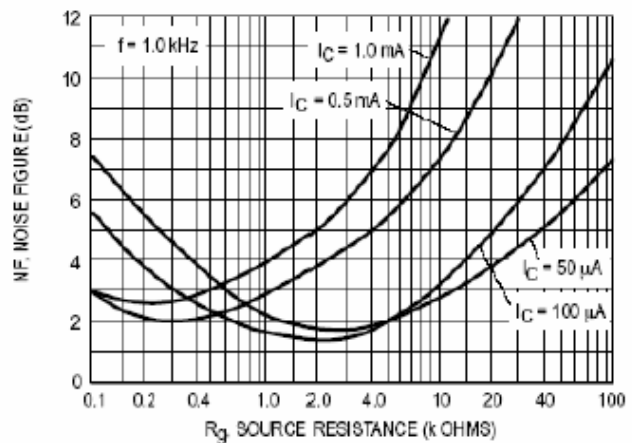

Figure 6

RATINGS AND CHARACTERISTIC CURVES (MMBT3906)

h PARAMETERS

($V_{CE} = -10$ Vdc, $f = 1.0$ kHz, $T_A = 25^\circ\text{C}$)

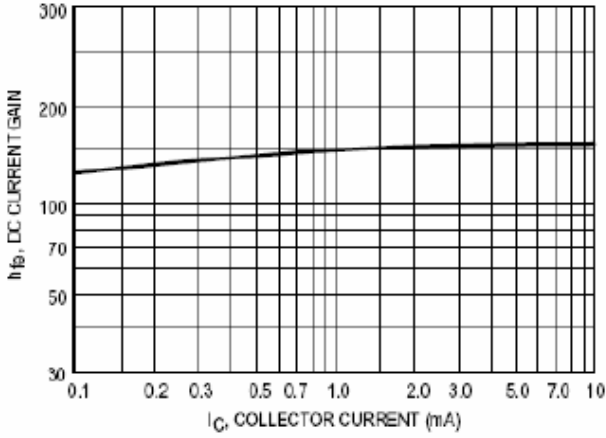

Figure 7 Current Gain

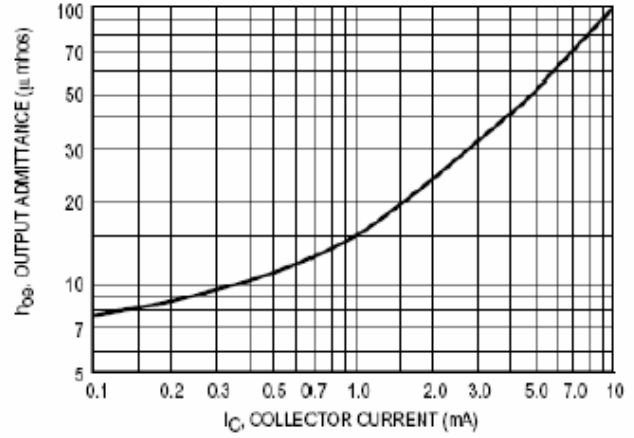

Figure 8 Output Admittance

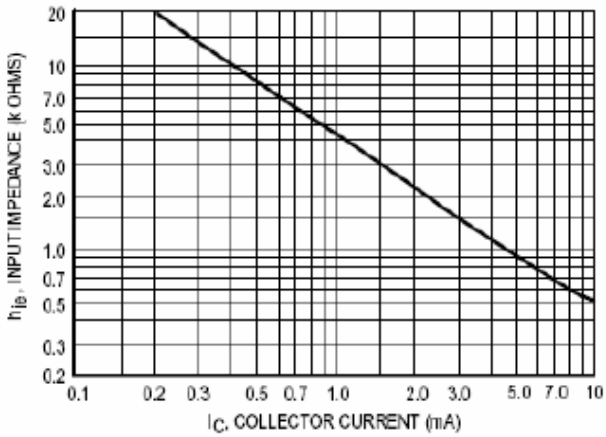

Figure 9 Input Impedance

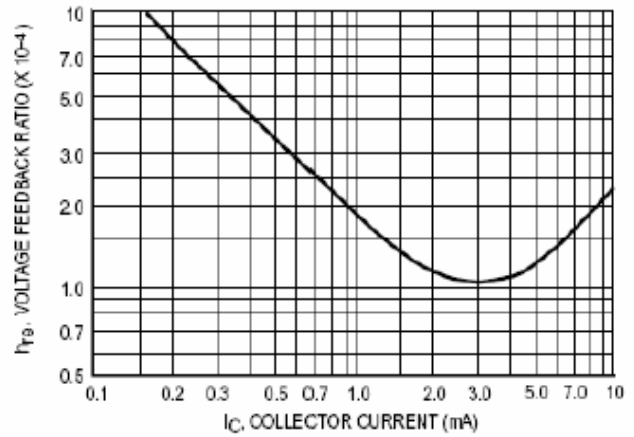

Figure 10 Voltage Feedback Ratio

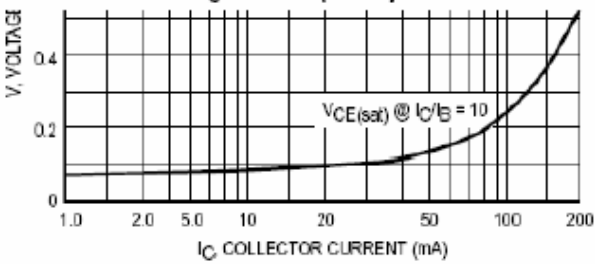

Figure 11 "ON" Voltages

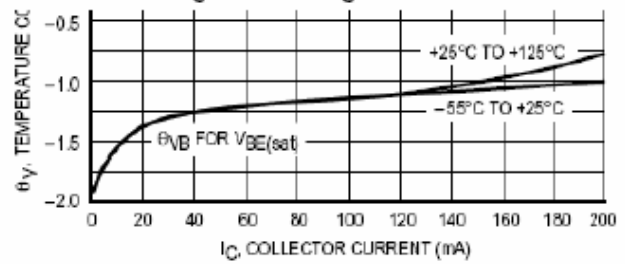

Figure 12 Temperature Coefficients