

## Standard chip resistors sizes 1206, 0805, 0603 and 0402

### RC01/11/21/31

#### FEATURES

- Low assembly costs
- High component and equipment reliability
- Excellent performance at high frequency, especially the RC31
- Complete standard SMD family.

#### APPLICATIONS

- All general purpose applications.

#### DESCRIPTION

The resistors are constructed on a high grade ceramic body (aluminium oxide). Internal metal electrodes are added at each end and connected by a resistive paste which is applied to the top surface of the substrate. The composition of the paste is adjusted to give the approximate resistance required and the value is trimmed to within tolerance, by laser cutting of this resistive layer.

The resistive layer is covered with a protective coat and printed with the resistance value. Finally, the two external end terminations are added. For ease of soldering the outer layer of these end terminations is a lead/tin alloy.

#### QUICK REFERENCE DATA

DESCRIPTION	VALUE			
	RC01	RC11	RC21	RC31 <sup>(1)</sup>
Size code	1206 (3216)	0805 (2012)	0603 (1608)	0402(1005)
Resistance range	1 Ω to 10 MΩ			10 Ω to 1 MΩ
Resistance tolerance and E-series	±5%, ±2%; E24 series			
Temperature coefficient: 1 Ω ≤ R < 5 Ω 5 Ω ≤ R ≤ 10 MΩ	≤ ±250 × 10 <sup>-6</sup> /K ≤ ±200 × 10 <sup>-6</sup> /K			≤ ±200 × 10 <sup>-6</sup> /K
Maximum dissipation at T <sub>amb</sub> = 70 °C	0.25 W	0.125 W	0.063 W	0.063 W
Maximum permissible voltage	200 V (DC or RMS)	150 V (DC or RMS)	50 V (DC or RMS)	50 V (DC or RMS)
Climatic category (IEC 68)	55/155/56			55/125/56
Basic specification	IEC 115-8			
Stability after: load, 1000 hours at T <sub>amb</sub> = 70 °C: 1 Ω ≤ R ≤ 1 MΩ R > 1 MΩ climatic tests: 1 Ω ≤ R ≤ 1 MΩ R > 1 MΩ resistance to soldering heat short time overload	ΔR/R max.: ±1.5% +0.1 Ω ΔR/R max.: ±3.0% +0.1 Ω  ΔR/R max.: ±1.5% +0.1 Ω ΔR/R max.: ±3.0% +0.1 Ω  ΔR/R max.: ±0.5% +0.05 Ω ΔR/R max.: ±1.0% +0.05 Ω			ΔR/R max.: ±3.0% +0.1 Ω  ΔR/R max.: ±1.0% +0.1 Ω  ΔR/R max.: ±1.0% +0.1 Ω ΔR/R max.: ±2.0% +0.1 Ω

#### Note

1. Data for RC31 is preliminary.

# Standard chip resistors sizes 1206, 0805, 0603 and 0402

RC01/11/21/31

## ORDERING INFORMATION

**Table 1** Ordering code indicating resistor type and packaging

TYPE	TOL. (%)	ORDERING CODE 2322 ... ..					
		CARDBOARD TAPE ON REEL <sup>(3)</sup>			BULK CASE		
		5000 units	10000 units	20000 units	10000 units	25000 units	100000 units
RC01	±5	711 61...	711 51...	711 81...	–	–	–
	±2	711 41...	–	711 71...	–	–	–
RC11	±5	730 61...	730 71...	730 81...	731 81...	–	–
	±2	730 31...	–	730 41...	731 51...	–	–
RC21	±5	702 60...	702 70...	702 81...	–	702 80...	–
	±2	702 65...	–	702 75...	–	702 50...	–
RC31	±5	–	705 70...	–	–	–	705 80...
<b>Jumper 0 Ω</b>							
RC01 <sup>(1)</sup>	–	711 91032	711 91005	711 92004	–	–	–
RC11 <sup>(1)</sup>	–	730 91002	730 91003	730 92002	731 91006	–	–
RC21 <sup>(2)</sup>	–	702 96001	702 97001	702 92002	–	702 91002	–
RC31 <sup>(2)</sup>	–	–	705 91001	–	–	–	705 91005

### Notes

1. The jumper has a maximum resistance  $R_{\max} = 50 \text{ m}\Omega$  and a rated current  $I_R = 2 \text{ A}$ .
2. The jumper has a maximum resistance  $R_{\max} = 50 \text{ m}\Omega$  and a rated current  $I_R = 1 \text{ A}$ .
3. Embossed carrier tape available on request for types RC01 and RC11.

### Ordering code (12NC)

- The resistors have a 12-digit ordering code starting with 2322
- The subsequent 5 digits indicate the resistor type and packaging; see Table 1.
- The remaining 3 digits indicate the resistance value:
  - The first 2 digits indicate the resistance value.
  - The last digit indicates the resistance decade in accordance with Table 2.

**Table 2** Last digit of 12NC

RESISTANCE DECADE	LAST DIGIT
1 to 9.76 Ω	8
10 to 97.6 Ω	9
100 to 976 Ω	1
1 to 9.76 kΩ	2
10 to 97.6 kΩ	3
100 to 976 kΩ	4
1 to 9.76 MΩ	5
10 MΩ	6

### ORDERING EXAMPLE

The ordering code of a RC11 resistor, value 4700 Ω with ±2% tolerance, supplied on cardboard tape of 5000 units per reel is:  
2322 730 31472.

# Standard chip resistors sizes 1206, 0805, 0603 and 0402

RC01/11/21/31

## FUNCTIONAL DESCRIPTION

### Product characterization

Standard values of nominal resistance are taken from the E24 series for resistors with a tolerance of  $\pm 5\%$  or  $\pm 2\%$ . The values of the E24 series are in accordance with "IEC publication 63".

### Limiting values

TYPE	LIMITING VOLTAGE <sup>(1)</sup> (V)	LIMITING POWER (W)
RC01	200	0.25
RC11	150	0.125
RC21	50	0.063
RC31		

### Note

- This is the maximum voltage that may be continuously applied to the resistor element, see "IEC publication 115-8".

## DERATING

The power that the resistor can dissipate depends on the operating temperature; see Fig.1.

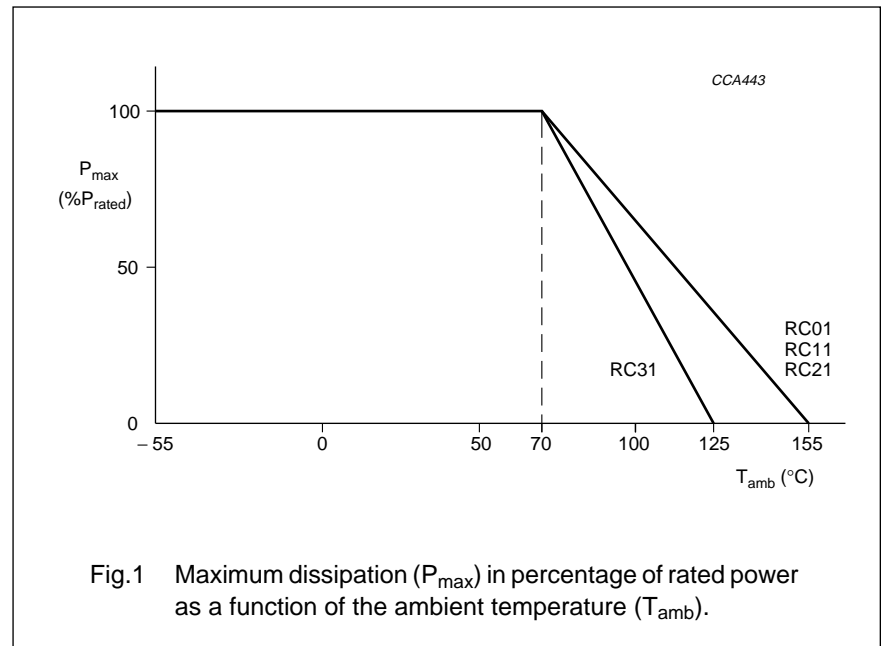

## PULSE LOADING CAPABILITIES

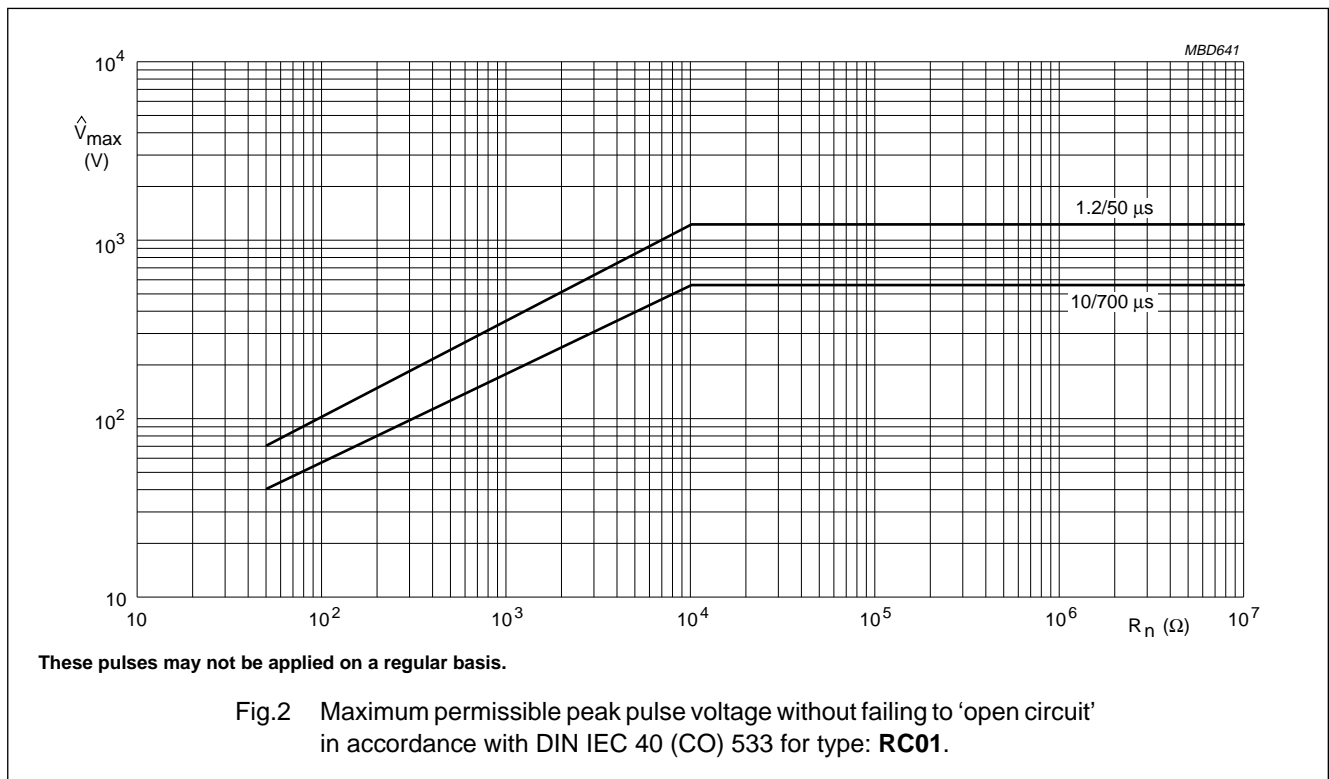

Standard chip resistors  
 sizes 1206, 0805, 0603 and 0402

RC01/11/21/31

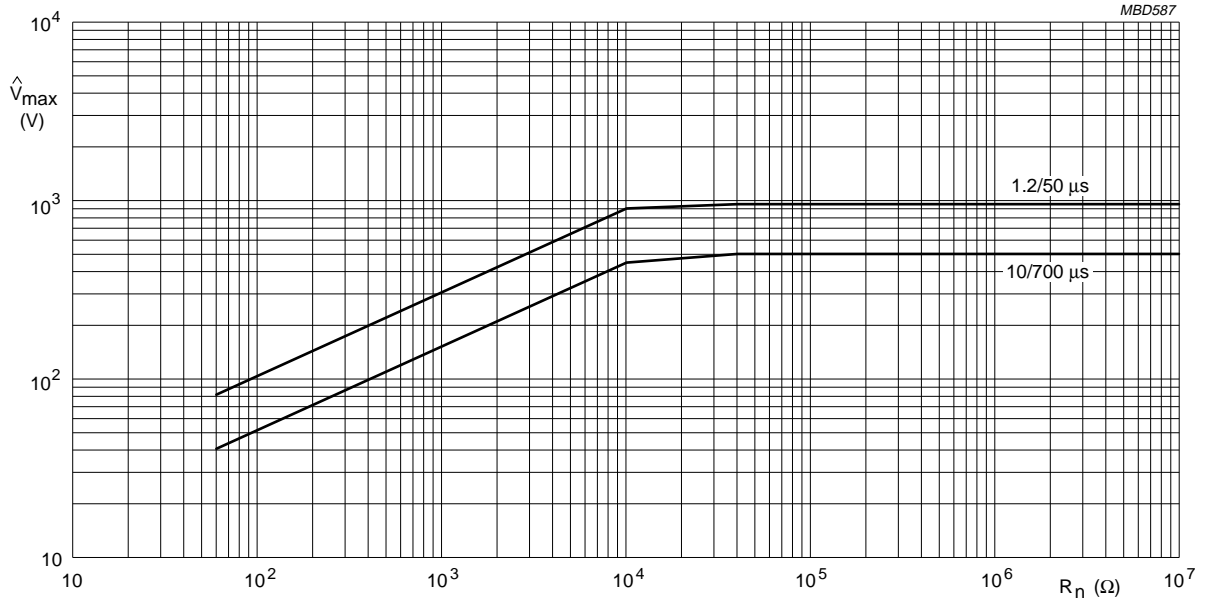

These pulses may not be applied on a regular basis.

Fig.3 Maximum permissible peak pulse voltage without failing to 'open circuit' in accordance with DIN IEC 40 (CO) 533 for type: **RC11**.

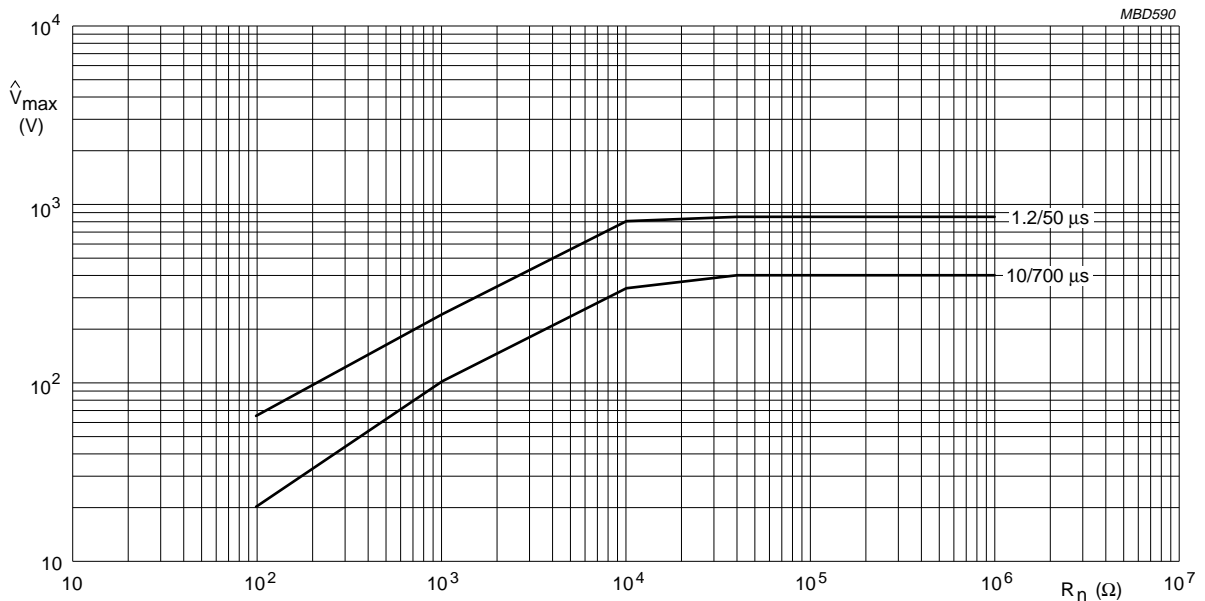

These pulses may not be applied on a regular basis.

Fig.4 Maximum permissible peak pulse voltage without failing to 'open circuit' in accordance with DIN IEC 40 (CO) 533 for type: **RC21**.

Standard chip resistors  
 sizes 1206, 0805, 0603 and 0402

RC01/11/21/31

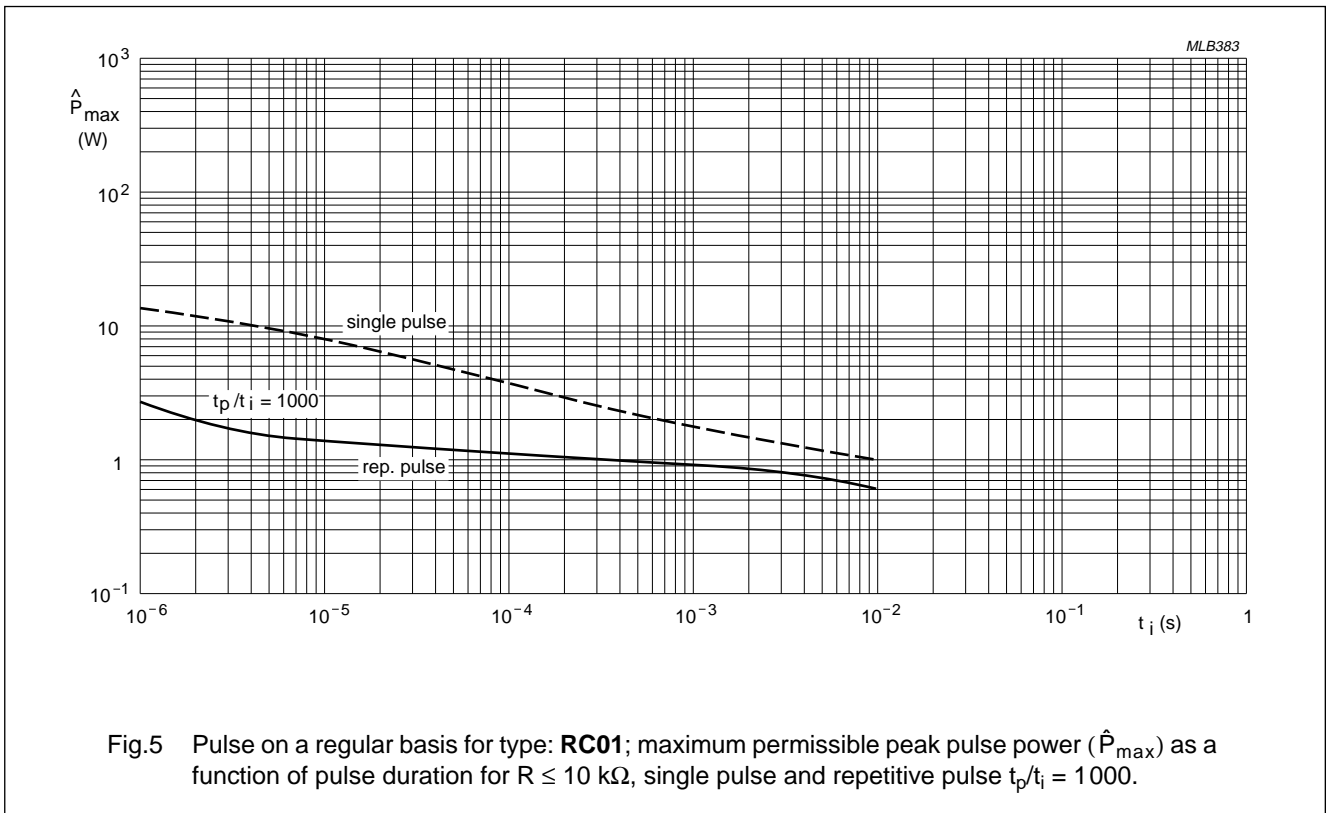

Fig.5 Pulse on a regular basis for type: **RC01**; maximum permissible peak pulse power ( $\hat{P}_{max}$ ) as a function of pulse duration for  $R \leq 10 \text{ k}\Omega$ , single pulse and repetitive pulse  $t_p/t_i = 1000$ .

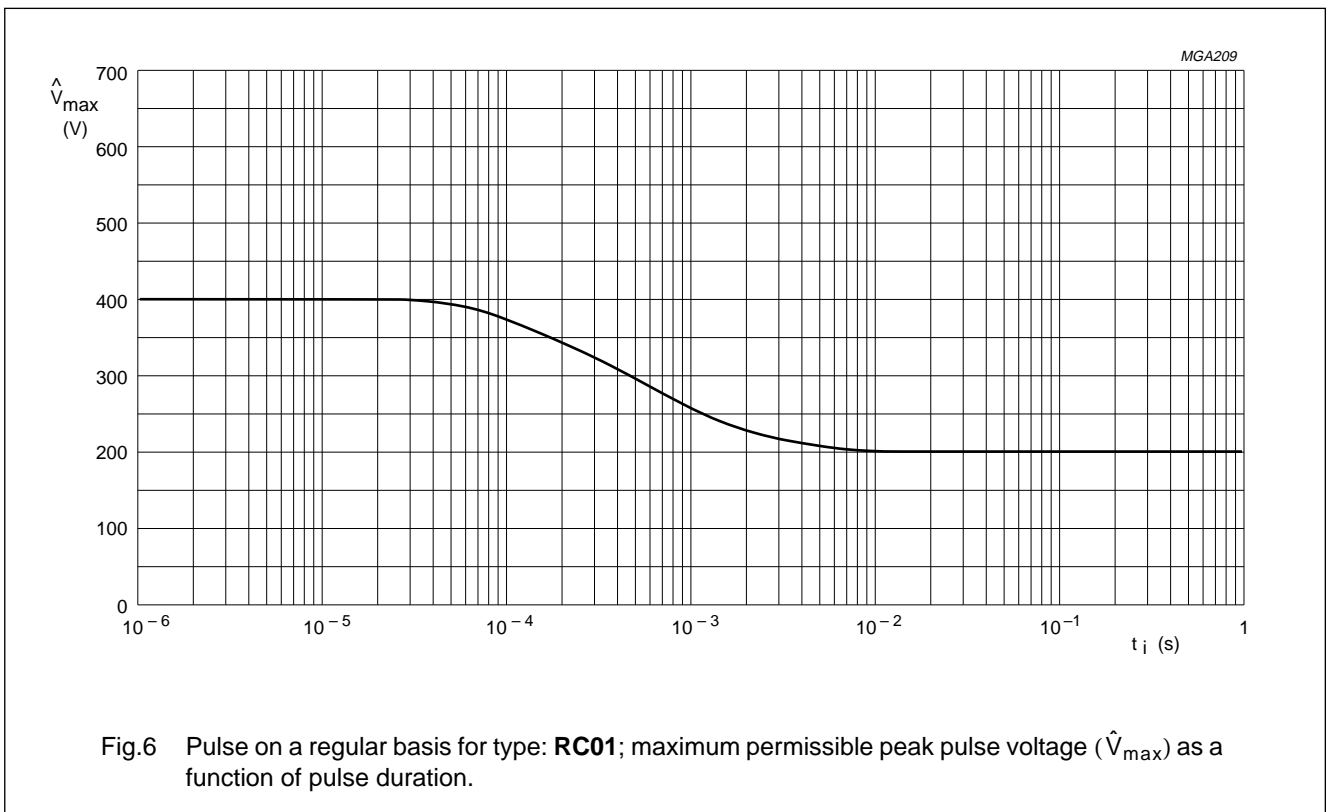

Fig.6 Pulse on a regular basis for type: **RC01**; maximum permissible peak pulse voltage ( $\hat{V}_{max}$ ) as a function of pulse duration.

Standard chip resistors  
 sizes 1206, 0805, 0603 and 0402

RC01/11/21/31

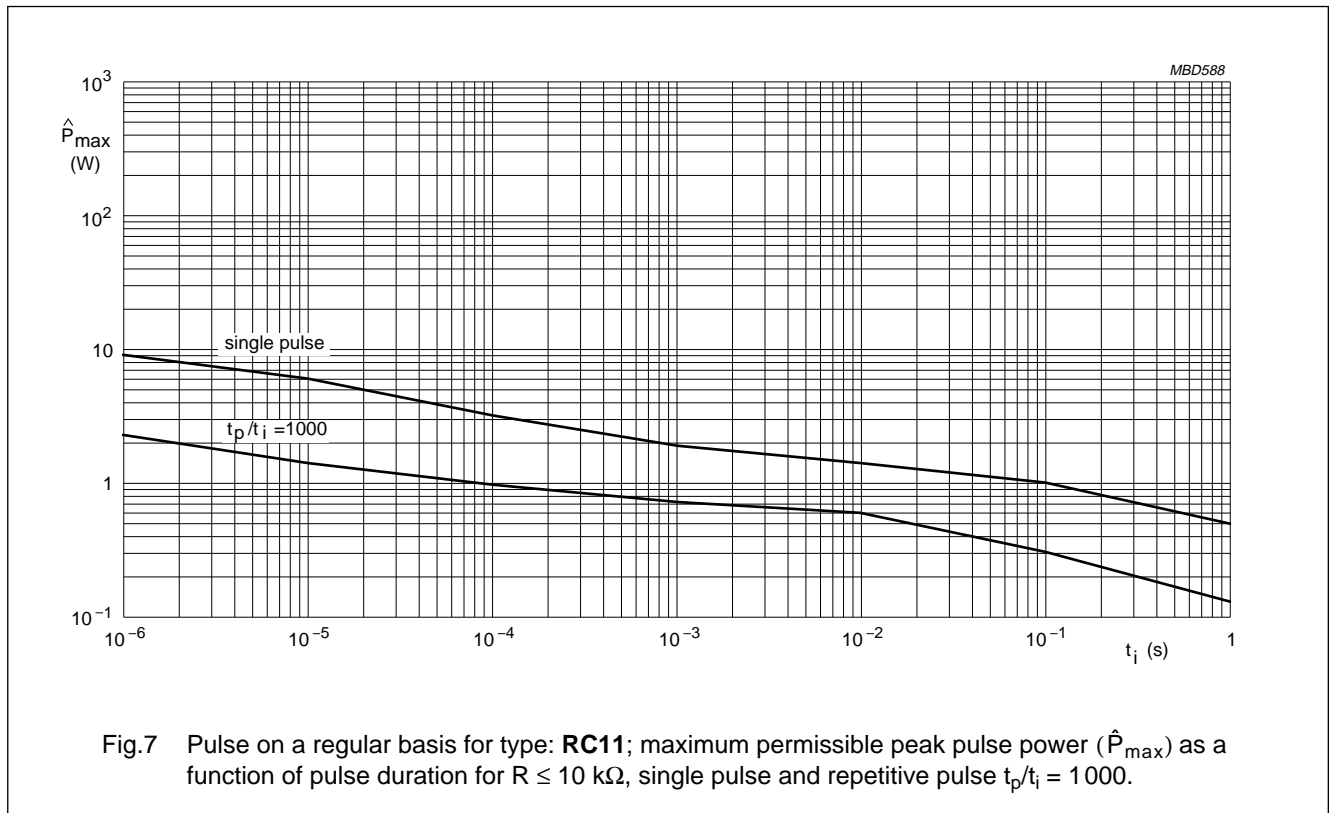

Fig.7 Pulse on a regular basis for type: **RC11**; maximum permissible peak pulse power ( $\hat{P}_{max}$ ) as a function of pulse duration for  $R \leq 10 \text{ k}\Omega$ , single pulse and repetitive pulse  $t_p/t_i = 1000$ .

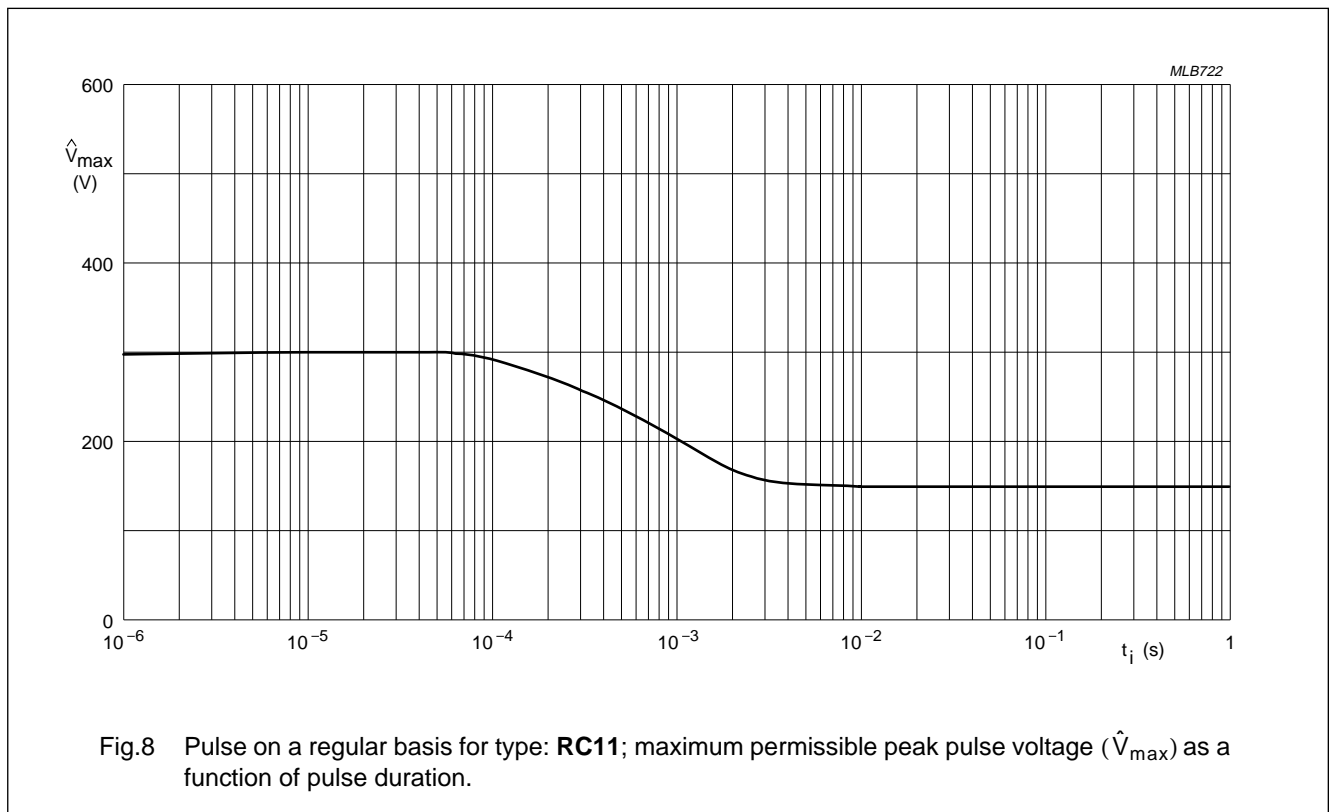

Fig.8 Pulse on a regular basis for type: **RC11**; maximum permissible peak pulse voltage ( $\hat{V}_{max}$ ) as a function of pulse duration.

Standard chip resistors  
 sizes 1206, 0805, 0603 and 0402

RC01/11/21/31

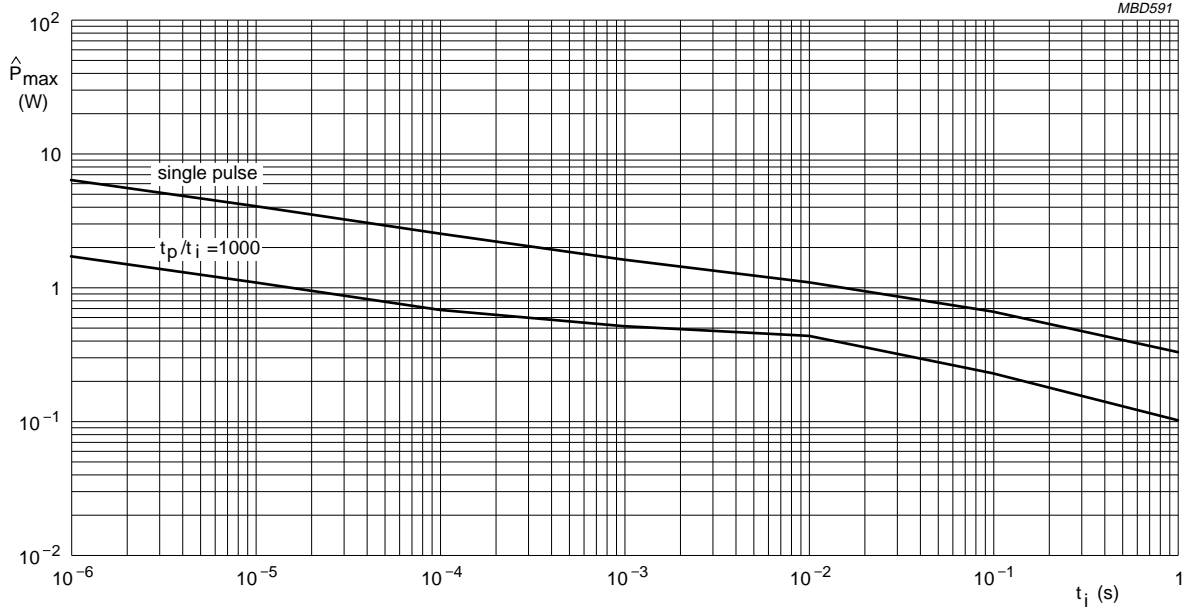

Fig.9 Pulse on a regular basis for type: **RC21**; maximum permissible peak pulse power ( $\hat{P}_{max}$ ) as a function of pulse duration for  $R \leq 10 \text{ k}\Omega$ , single pulse and repetitive pulse  $t_p/t_i = 1000$ .

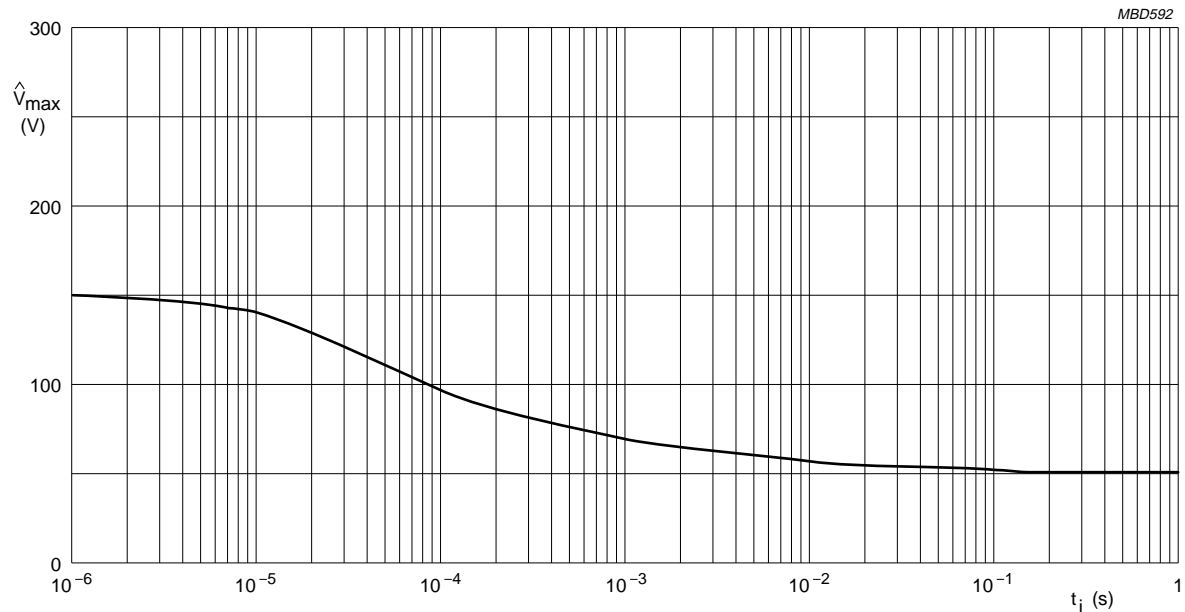

Fig.10 Pulse on a regular basis for type: **RC21**; maximum permissible peak pulse voltage ( $\hat{V}_{max}$ ) as a function of pulse duration.

# Standard chip resistors sizes 1206, 0805, 0603 and 0402

RC01/11/21/31

## MECHANICAL DATA

### Mass per 100 units

TYPE	MASS (g)
RC01	1.0
RC11	0.55
RC21	0.25
RC31	0.052

### Marking

Each resistor, except RC31, is marked with a three digit code (occasionally four digit) on the protective coating to designate the nominal resistance value.

#### 3-DIGIT MARKING

For values up to 91 Ω the R is used as a decimal point. For values of 100 Ω or greater the first 2 digits are significant, the third indicates the number of zeros to follow.

#### Example

MARKING	RESISTANCE
12R	12 Ω
823	82 kΩ

#### 4-DIGIT MARKING

For values up to 976 Ω the R is used as a decimal point. For values of 1 kΩ or greater the first 3 digits are significant, the fourth indicates the number of zeros to follow.

#### Example

MARKING	RESISTANCE
12R0	12 Ω
8202	82 kΩ

The packaging is also marked and includes resistance value, tolerance, TC value, catalogue number, quantity, production period, batch number and source code.

## Outlines

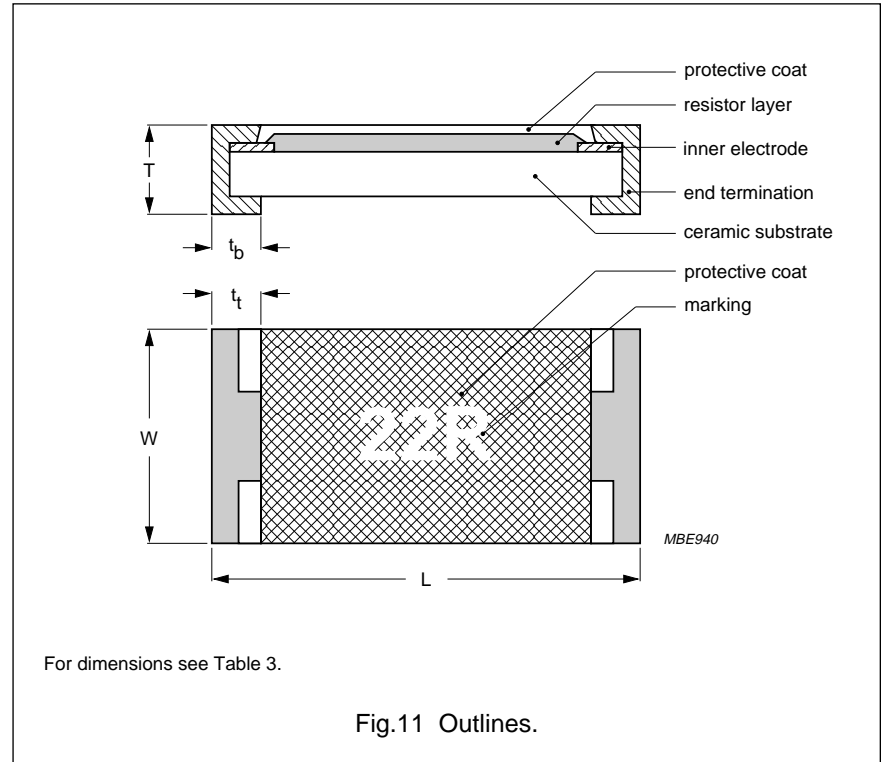

Table 3 Chip resistor types and relevant physical dimensions; see Fig.11

TYPE	L (mm)	W (mm)	T (mm)	t <sub>t</sub> (mm)	t <sub>b</sub> (mm)
RC01	3.20 +0.10/-0.20	1.60 ±0.15	0.55 ±0.10	0.45 ±0.25	0.50 ±0.25
RC11	2.00 ±0.15	1.25 ±0.15	0.55 ±0.10	0.40 ±0.20	0.40 ±0.20
RC21	1.60 ±0.10	0.80 +0.15/-0.05	0.45 ±0.10	0.30 ±0.20	0.30 ±0.20
RC31	1.00 ±0.05	0.50 ±0.05	0.35 ±0.05	0.20 ±0.10	0.25 ±0.10



Standard chip resistors  
sizes 1206, 0805, 0603 and 0402

RC01/11/21/31

Unless otherwise specified the following values apply:

Temperature: 15 °C to 35 °C

Relative humidity: 45% to 75%

Air pressure: 86 kPa to 106 kPa (860 mbar to 1060 mbar).

In Table 4 the tests and requirements are listed with reference to the relevant clauses of "IEC publications 115-8 and 68"; a short description of the test procedure is also given. In some instances deviations from the IEC recommendations were necessary for our method of specifying.

All soldering tests are performed with mildly activated flux.

## TESTS AND REQUIREMENTS

Essentially all tests are carried out in accordance with the schedule of "IEC publication 115-8", category **LCT/UCT/56** (rated temperature range: Lower Category Temperature, Upper Category Temperature; damp heat, long term, **56** days). The testing also covers the requirements specified by EIA and EIAJ.

The tests are carried out in accordance with IEC publication 68, "Recommended basic climatic and mechanical robustness testing procedure for electronic components" and under standard atmospheric conditions according to "IEC 68-1", subclause 5.3.

**Table 4** Test procedures and requirements

IEC 115-8 CLAUSE	IEC 68-2 TEST METHOD	TEST	PROCEDURE	RESISTANCE RANGE	REQUIREMENTS			
					RC01	RC11	RC21	RC31
<b>Tests in accordance with the schedule of IEC publication 115-8</b>								
4.4.1		visual examination			no holes; clean surface; no damage			
4.4.2		dimensions (outline; see Fig.11)	gauge (mm)		$0.45 \leq T \leq 0.65$ $1.45 \leq W \leq 1.75$ $3.0 \leq L \leq 3.3$	$0.45 \leq T \leq 0.65$ $1.10 \leq W \leq 1.40$ $1.85 \leq L \leq 2.15$	$0.35 \leq T \leq 0.55$ $0.75 \leq W \leq 0.95$ $1.50 \leq L \leq 1.70$	$0.30 \leq T \leq 0.40$ $0.45 \leq W \leq 0.55$ $0.95 \leq L \leq 1.05$
4.5		resistance	applied voltage (+0/-10%): $R < 10 \Omega$ : 0.1 V $10 \Omega \leq R < 100 \Omega$ : 0.3 V $100 \Omega \leq R < 1 \text{ k}\Omega$ : 1 V $1 \text{ k}\Omega \leq R < 10 \text{ k}\Omega$ : 3 V $10 \text{ k}\Omega \leq R < 100 \text{ k}\Omega$ : 10 V $100 \text{ k}\Omega \leq R < 1 \text{ M}\Omega$ : 25 V $R \geq 1 \text{ M}\Omega$ : 50 V		$R - R_{\text{nom}}$ : max. $\pm 2\%$ or $R - R_{\text{nom}}$ : max. $\pm 5\%$			$R - R_{\text{nom}}$ : max. $\pm 5\%$

Standard chip resistors  
sizes 1206, 0805, 0603 and 0402

RC01/11/21/31

IEC 115-8 CLAUSE	IEC 68-2 TEST METHOD	TEST	PROCEDURE	RESISTANCE RANGE	REQUIREMENTS			
					RC01	RC11	RC21	RC31
4.18	20 (Ta)	resistance to soldering heat	unmounted chips; 10 s; 260 ±5 °C		no visual damage $\Delta R/R$ max.: ±0.5% +0.05 Ω;			no visual damage $\Delta R/R$ max.: ±1% +0.1 Ω
4.29	45 (Xa)	component solvent resistance	isopropyl alcohol or H <sub>2</sub> O followed by brushing in accordance with "MIL 202 F"		no visual damage			
4.17	20 (Ta)	solderability	unmounted chips completely immersed for 2 ±0.5 s in a solder bath at 235 ±5 °C		good tinning (≥95% covered); no visual damage			
4.7		voltage proof on insulation	maximum voltage (RMS) during 1 minute metal block method		no breakdown or flashover			
4.13		short time overload	room temperature; P = 6.25 × P <sub>n</sub> ; 5 s ( $V \leq 2 \times V_{max}$ )		$\Delta R/R$ max.: ±1% +0.05 Ω			$\Delta R/R$ max.: ±2% +0.1 Ω
4.33		bending	resistors mounted on a 90 mm glass epoxy resin PCB (FR4), bending: 3 mm for <b>RC01</b> and 5 mm for <b>RC11</b> , <b>RC21</b> and <b>RC31</b>		no visual damage $\Delta R/R$ max.: ±1% +0.05 Ω			
4.19	14 (Na)	rapid change of temperature	30 minutes at LCT and 30 minutes at UCT; 5 cycles		no visual damage $\Delta R/R$ max.: ±0.5% +0.05 Ω			no visual damage $\Delta R/R$ max.: ±2% +0.1 Ω
4.23		climatic sequence:						
4.23.3	30 (D)	damp heat (accelerated) 1st cycle						
4.23.6	30 (D)	damp heat (accelerated) remaining cycles	6 days; 55 °C; 95 to 98% RH					
				R ≤ 1 MΩ	R <sub>ins</sub> min.: 10 <sup>4</sup> MΩ			
				R > 1 MΩ	$\Delta R/R$ max.: ±1.5% +0.1 Ω			$\Delta R/R$ max.: ±1% +0.1 Ω
					$\Delta R/R$ max.: ±3% +0.1 Ω			not applicable

Standard chip resistors  
sizes 1206, 0805, 0603 and 0402

RC01/11/21/31

IEC 115-8 CLAUSE	IEC 68-2 TEST METHOD	TEST	PROCEDURE	RESISTANCE RANGE	REQUIREMENTS			
					RC01	RC11	RC21	RC31
4.24.2	3 (Ca)	damp heat (steady state) (IEC)	56 days; 40 °C; 90 to 95% RH; loaded with 0.01 P <sub>n</sub> (IEC steps: 4 to 100 V)	R ≤ 1 MΩ R > 1 MΩ	ΔR/R max.: ±1.5% +0.1 Ω ΔR/R max.: ±3% +0.1 Ω			ΔR/R max.: ±3% +0.1 Ω not applicable
4.25.1		endurance (at 70 °C)	1000 hours; loaded with P <sub>n</sub> or V <sub>max</sub> ; 1.5 hours on and 0.5 hours off	R ≤ 1 MΩ R > 1 MΩ	ΔR/R max.: ±1.5% +0.1 Ω ΔR/R max.: ±3% +0.1 Ω			ΔR/R max.: ±3% +0.1 Ω not applicable
4.23.2	27 (Ba)	endurance at upper category temperature	1000 hours; no load	R ≤ 1 MΩ R > 1 MΩ	ΔR/R max.: ±1.5% +0.1 Ω ΔR/R max.: ±3% +0.1 Ω			ΔR/R max.: ±3% +0.1 Ω not applicable
4.8.4.2		temperature coefficient	at 20/LCT/20 °C and 20/UCT/20 °C (TC × 10 <sup>-6</sup> /K)	R < 5 Ω R ≤ 10 MΩ	≤ ±250 ≤ ±200			not applicable ≤ ±200
<b>Other tests in accordance with IEC 115 clauses and IEC 68 test method</b>								
4.17	20 (Tb)	solderability (after ageing)	8 hours steam or 16 hours 155 °C; unmounted chips completely immersed for 2 ±0.5 s in a solder bath at 235 ±5 °C		good tinning (≥95% covered); no damage			
4.6.1.1		insulation resistance	voltage (DC) after 1 minute, metal block method: 100 V for <b>RC01</b> and <b>RC11</b> , 50 V for <b>RC21</b> and <b>RC31</b>		R <sub>ins</sub> min.: 10 <sup>3</sup> MΩ			
4.12		noise	IEC publication 195 (measured with Quantech - equipment)	R ≤ 1 kΩ R ≤ 10 kΩ R ≤ 100 kΩ R ≤ 1 MΩ	max. 1 μV/V max. 3 μV/V max. 6 μV/V max. 10 μV/V			
<b>Other applicable tests</b>								
		humidity load (steady state) (JIS)	1000 hours; +40 °C; 90 to 95% RH; loaded with P <sub>n</sub> or V <sub>max</sub> ; 1.5 hours on and 0.5 hours off	R ≤ 1 MΩ R > 1 MΩ	ΔR/R max.: ±3% +0.1 Ω ΔR/R max.: ±5% +0.1 Ω			not applicable
		leaching	unmounted chips; 60 s; 260 ±5 °C		good tinning; no leaching			
		trio damp heat test	1 000 hours; +85 °C; 85% RH; loaded with 0.1 P <sub>n</sub> or V <sub>max</sub>	R ≤ 1 MΩ R > 1 MΩ	ΔR/R max.: ±3% +0.1 Ω ΔR/R max.: ±5% +0.1 Ω			not applicable