

Switching (30V, 7A)

RK9410

●Features

- 1) Low Qg.
- 2) Low on-resistance.
- 3) Excellent resistance to damage from static electricity.

●Structure

Silicon N-channel
MOS FET

●Equivalent circuit

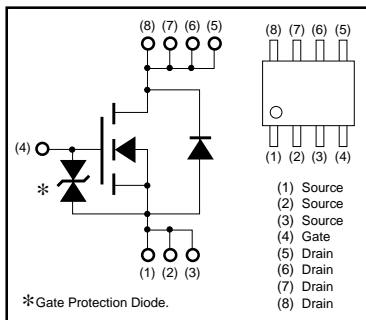

* A protection diode is included between the gate and the source terminals to protect the diode against static electricity when the product is in use. Use a protection circuit when the fixed voltage are exceeded.

●External dimensions (Units : mm)

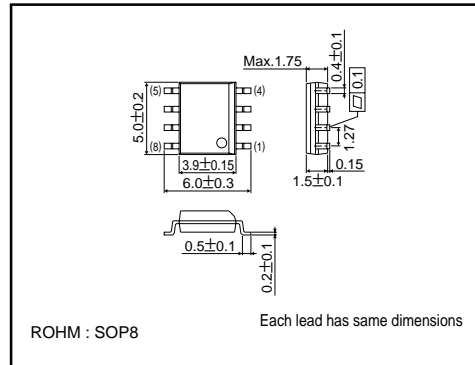

●Absolute maximum ratings (Ta=25°C)

Parameter	Symbol	Limits	Unit	
Drain-Source Voltage	V _{DSS}	30	V	
Gate-Source Voltage	V _{GSS}	±20	V	
Drain Current	Continuous	I _D	7	A
	Pulsed	I _{DP} *	28	A
Reverse Drain Current	Continuous	I _{DR}	7	A
	Pulsed	I _{DRP} *	28	A
Source Current (Body Diode)	Continuous	I _S	1.3	A
	Pulsed	I _{SP} *	5.2	A
Total Power Dissipation (Tc=25°C)	P _D	2	W	
Channel Temperature	T _{ch}	150	°C	
Storage Temperature	T _{stg}	-55~+150	°C	

* Pw≤10ms, Duty cycle≤1%

Transistors

● Thermal resistance (Ta=25°C)

Parameter	Symbol	Limits	Unit
Channel to Ambient	Rth(ch-A)	62.5	°C / W

● Electrical characteristics (Ta=25°C)

Parameter	Symbol	Min.	Typ.	Max.	Unit	Test Conditions
Gate-Source Leakage	I _{GSS}	–	–	±10	μA	V _{GS} =±20V, V _{DS} =0V
Drain-Source Breakdown Voltage	V _{(BR) DSS}	30	–	–	V	I _D =1mA, V _{GS} =0V
Zero Gate Voltage Drain Current	I _{DSS}	–	–	1	μA	V _{DS} =30V, V _{GS} =0V
Gate Threshold Voltage	V _{GS(th)}	1.0	–	2.5	V	V _{DS} =10V, I _D =1mA
Static Drain-Source On-State Resistance	R _{DS(on)}	–	18	23	mΩ	I _D =7A, V _{GS} =10V
		–	28	37		I _D =7A, V _{GS} =4.5V
		–	33	43		I _D =7A, V _{GS} =4V
Forward Transfer Admittance	I _{Yfs} I*	5	–	–	S	I _D =7A, V _{DS} =10V
Input Capacitance	C _{iss}	–	710	–	pF	V _{DS} =10V
Output Capacitance	C _{oss}	–	400	–	pF	V _{GS} =0V
Reverse Transfer Capacitance	C _{rss}	–	200	–	pF	f=1MHz
Turn-On Delay Time	t _{d(on)} *	–	12	–	ns	I _D =3.5A, V _{DD} ≒15V
Rise Time	t _r *	–	43	–	ns	V _{GS} =10V
Turn-Off Delay Time	t _{d(off)} *	–	48	–	ns	R _L =4.3Ω
Fall Time	t _f *	–	30	–	ns	R _{GS} =10Ω
Total Gate Charge	Q _g *	–	20.5	41	nC	V _{DD} =15V
Gate-Source Charge	Q _{gs} *	–	3.3	–	nC	V _{GS} =10V
Gate-Drain Charge	Q _{gd} *	–	5.2	–	nC	I _D =7A

* Pulsed

● Body diode characteristics (Source-Drain Characteristics) (Ta=25°C)

Parameter	Symbol	Min.	Typ.	Max.	Unit	Test Conditions
Forward Voltage	V _{SD} *	–	–	1.5	V	I _S =5.2A, V _{GS} =0V
Reverse Recovery Time	t _{rr} *	–	155	–	ns	I _{DR} =5.2A, V _{GS} =0V
Reverse Recovery Charge	Q _{rr} *	–	145	–	nC	di/dt=100A/μs

* Pulsed

Transistors

● Electrical characteristic curves

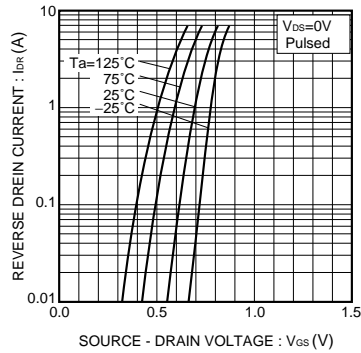

Fig.1 Reverse Drain Current vs. Source - Drain Voltage

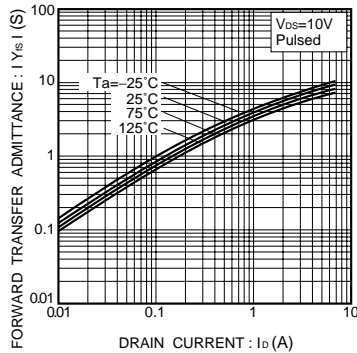

Fig.2 Forward Transfer Admittance vs. Drain Current

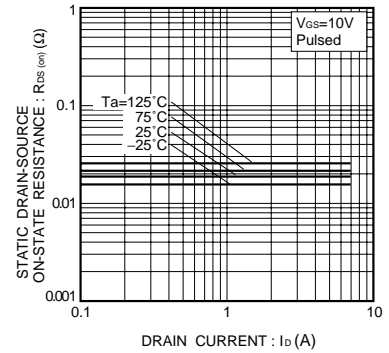

Fig.3 Static Drain-Source On-State Resistance vs. Drain Current (I)

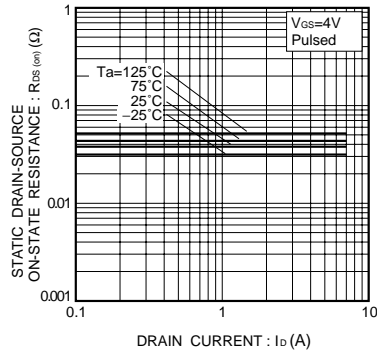

Fig.4 Static Drain-Source On-State Resistance vs. Drain Current (II)

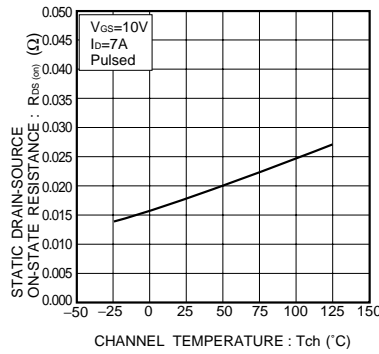

Fig.5 Static Drain-Source On-State Resistance vs. Channel Temperature

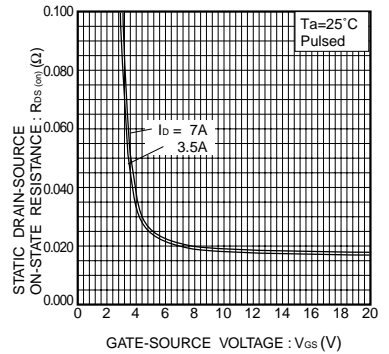

Fig.6 Static Drain-Source On-State Resistance vs. Gate-Source Voltage

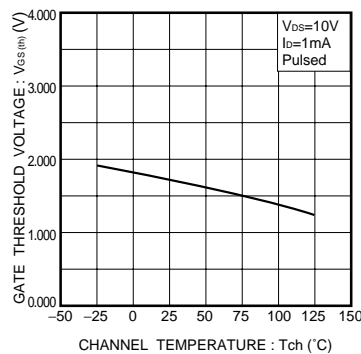

Fig.7 Gate Threshold Voltage vs. Channel Temperature

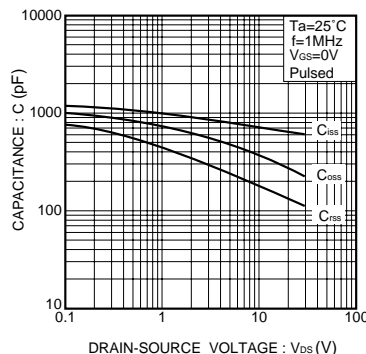

Fig.8 Typical Capacitance vs. Drain-Source Voltage

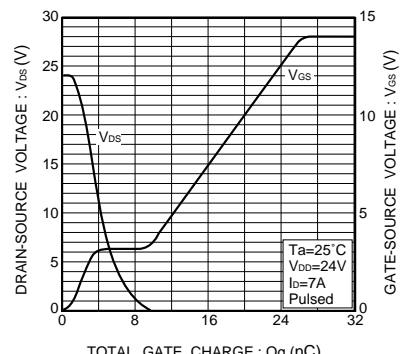

Fig.9 Dynamic Input Characteristics

Transistors

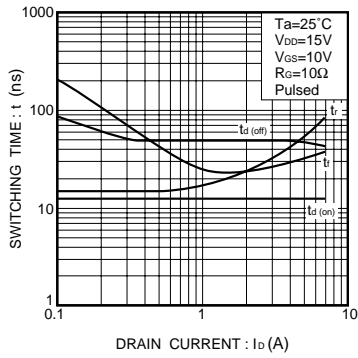

Fig.10 Switching Characteristics

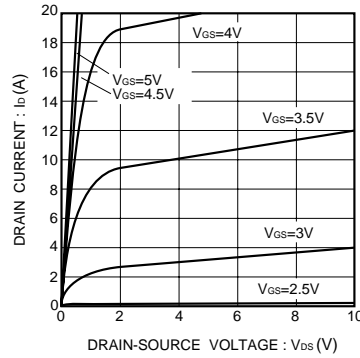

Fig.11 Typical Output Characteristics

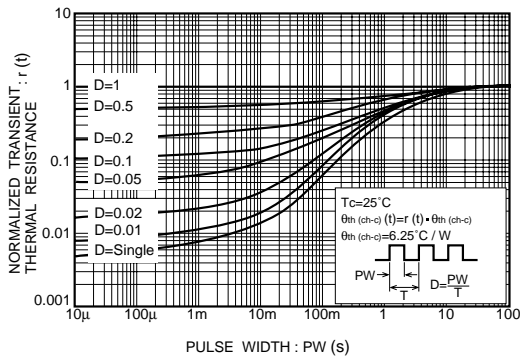

Fig.12 Normalized Transient Thermal Resistance vs. Pulse Width