

TC9488FG

Digital Echo IC for Karaoke

The TC9488FG is digital echo ICs for karaoke. The ICs incorporate microphone amps and volume controllers, enabling a digital echo system to be configured on a single chip.

Features

- Incorporates a two-channel microphone amp with auto level control (ALC), AD/DA converter, delay memory, and electronic volume controllers.
- Incorporates a 32-kHz sampling, 12-bit successive comparison AD/DA converter.
- Incorporates a delay memory (16-Kbit DRAM) which enables 128-ms (typ.) delay.
- Microphone and echo levels are controlled by built-in volume controllers. They are controlled either by DC voltage or controlled in serial by the MCU.
- TC9488FG: Supports three-lead interface
- The system clock is generated by the CR oscillator circuit.
- The echo feedback amount is configured using analog circuits. The feedback level can be freely set.
- The IC comes in 30-pin flat package.

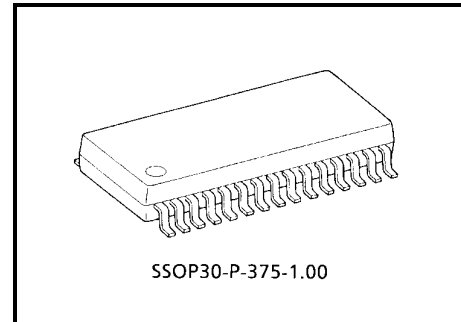

Weight: 1.08 g (typ.)

Pin Connection

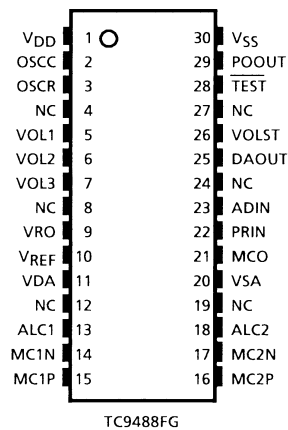

Block Diagram

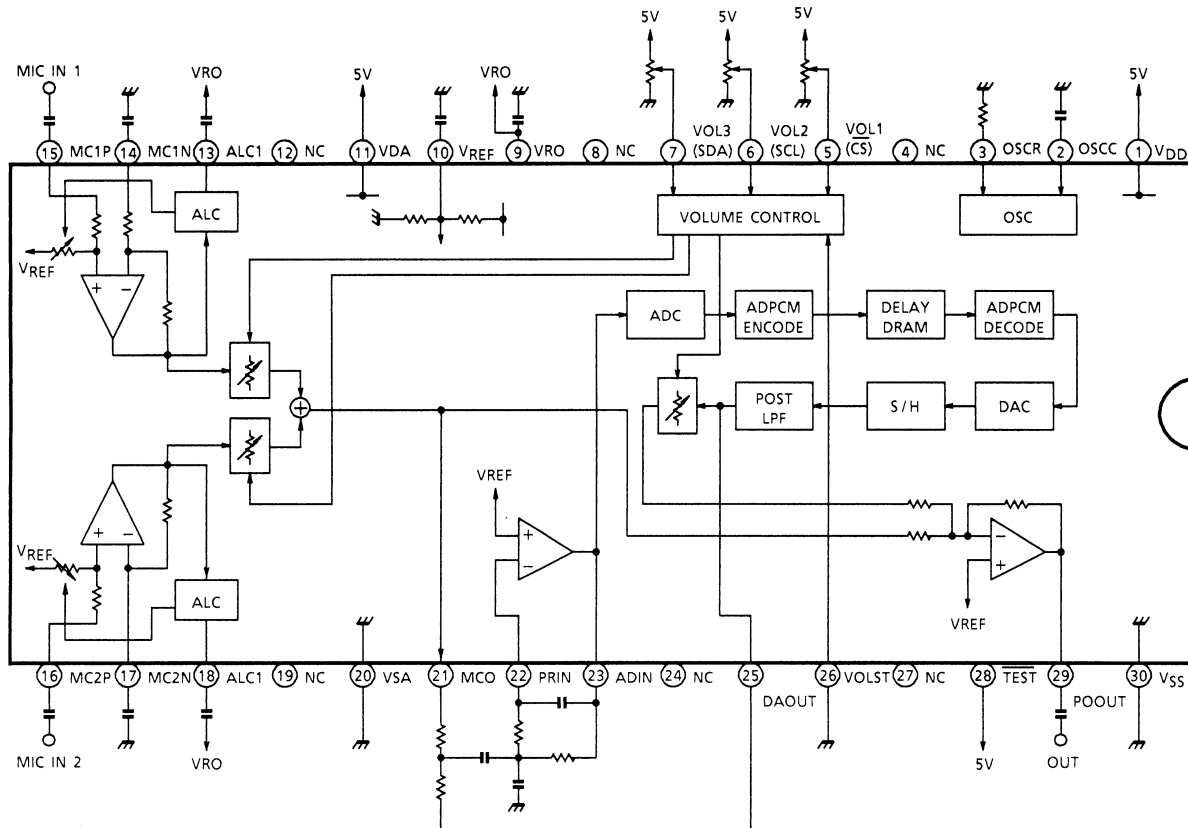

System Block Diagram

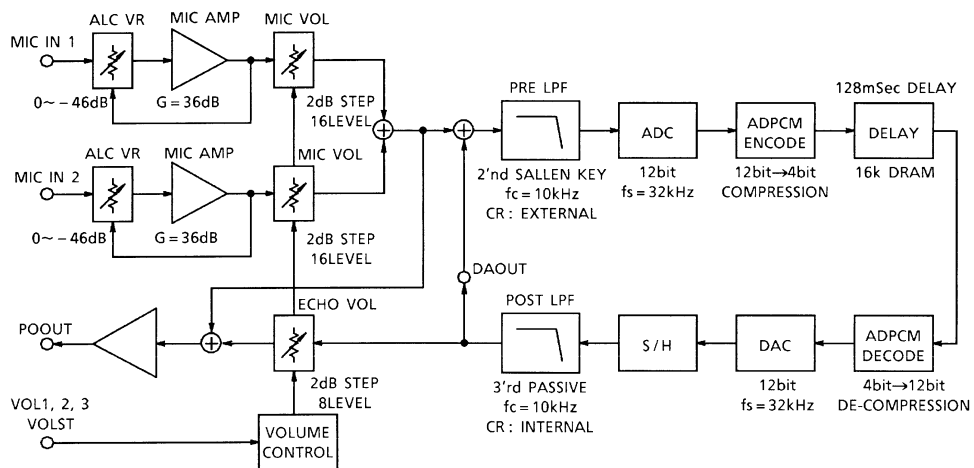

Pin Description (Note 1)

Pin Number	Symbol	I/O	Function	Remarks
1	V _{DD}	—	Digital supply voltage pin	
2	CSCC	I	Capacitor connecting pin for CR oscillator (C = 68 pF)	
3	OSCR	I	Resistor connecting pin for CR oscillator (R = 5.6 kΩ)	
5	VOL1 ($\overline{\text{CS}}$)	I	When VOLST = "H" level, $\overline{\text{CS}}$ signal input pin When VOLST = "L" level, DC control pin for MIC1 volume	
6	VOL2 (SCL)	I	When VOLST = "H" level, clock input pin When VOLST = "L" level, DC control pin for MIC2 volume	Open drain output
7	VOL3 (SDA)	I	When VOLST = "H" level, data input pin When VOLST = "L" level, DC control pin for echo volume	Open drain output
9	VRO	—	Reference voltage pin	
10	VREF	—	Reference voltage pin (1/2 V _{DD})	
11	VDA	—	Analog supply voltage pin	
13	ALC1	I	Auto level control pin 1	
14	MC1N	I	MIC1 feedback signal input pin	
15	MC1P	I	MIC1 signal input pin	
16	MC2P	I	MIC2 signal input pin	
17	MC2N	I	MIC2 feedback signal input pin	
18	ALC2	I	Auto level control pin 2	
20	VSA	—	Analog ground pin	
21	MCO	O	MIC addition signal output pin	
22	PRIN	I	Pre-filter input pin	
23	ADIN	I	Pre-filter output signal or DC input pin	
25	DAOUT	O	Post-filter output pin	
26	VOLST	I	Electronic volume control mode select pin When VOLST = "H" level, serial control (I ² C bus/three-lead) When VOLST = "L" level, DC level control	
28	$\overline{\text{TEST}}$	I	Test pin. Fix to "H" level for normal use	
29	POOUT	O	Microphone echo signal output pin	
30	V _{SS}	—	Digital ground pin	

Note 1: With the TC9488FG, pins 4, 8, 12, 19, 24, and 27 are not connected (NC pins).
NC pins are normally open.

Operation

1. Oscillator circuit

The TC9488FG generates an internal system clock using the CR oscillator circuit. Connecting a capacitance (C) of 68 pF and a resistance (R) of 5.6 kΩ sets the oscillator frequency to approx. 4 MHz and the sampling frequency to 32 kHz.

Varying the external capacitance enables the oscillator frequency and sampling frequency for the system clock to be adjusted. Varying the system clock enables the delay time to be adjusted.

Figure 1 shows the CR oscillator circuit.

1.1 How to determine oscillator frequency (f)

$$\begin{aligned}
 f \text{ [MHz]} &= 1532 / (C \text{ [pF]} \times R \text{ [k}\Omega\text{]}) \\
 &= 1532 / (68 \times 5.6) \\
 &\approx 4.0 \text{ MHz (Note 2)}
 \end{aligned}$$

Note 2: The oscillator frequency is a typical value (Ta = 25°C). Set the resistance to between 4.7 kΩ and 6.8 kΩ.

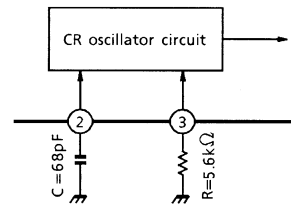

Figure 1
CR Oscillator circuit

1.2 How to determine sampling frequency (fs)

$$\begin{aligned}
 f_s \text{ [kHz]} &= f / 128 \\
 &= 4.0 / 128 \\
 &\approx 32 \text{ kHz}
 \end{aligned}$$

2. Microphone amps

The IC incorporates microphone amps with auto level control (ALC).

The microphone amp gain is typically 36dB.

When a signal from 0 to -46dB is input, the ALC circuit can control the output signal level.

Changing the external capacitor connected to the ALC circuit to a resistor sets the ALC circuit to off.

Figure 2 shows the microphone amp circuit.

When C = 4.7 μF, the attack and release times are as follows:

- Attack time = Approx. 29 ms
- Release time = Approx. 1.6 s

Setting the capacitance (C) to a smaller value enables the attack and release times to be adjusted. When the ALC circuit is not used, change the capacitor (*1) to a resistor (approx. 10 kΩ), and connect to GND line.

At power on, while the capacitor is being charged, no sound is output. So, use a capacitance of 4.7 μF or less.

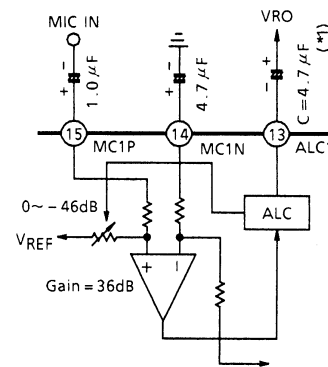

Figure 2
Microphone amp with ALC

3. AD/DA converter and digital delay circuit

The AD/DA converter is a 12-bit successive comparison type. The sampling frequency when the system clock operates at 4 MHz is 32 kHz.

The analog signal input from the AD converter is converted to 12-bit digital data. The digital delay circuit compresses the 12-bit signal to 4-bit, writes it to delay RAM, then reads it. The 4-bit data read from delay RAM is de-compressed to 12-bit. The 12-bit data are converted to analog signals by the DA converter and output.

The area for delay RAM memory is 4096 words \times 4 bits.

The echo delay time is 4096 words \times (1/32 kHz) = 128 ms.

Figure 3 is a block diagram of the echo circuit.

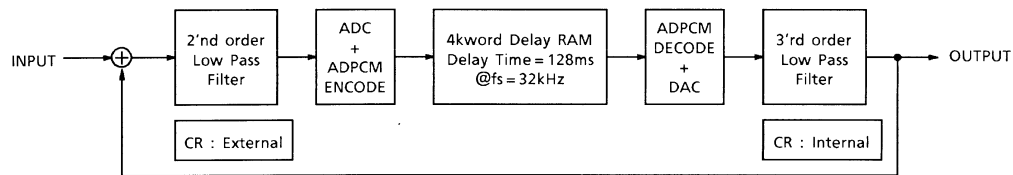

Figure 3 Block diagram of echo circuit

4. Electronic volume controllers

The IC incorporates microphone input 1 (MIC1) and microphone input 2 (MIC2) volume and echo volume controllers. The built-in volume controller operates in 16 steps. Using an external variable resistor, volume can be controlled by the DC level or from the MCU using serial data. The TC9488FG supports a three-lead interface.

4.1 Serial control timing

Figure 4 shows the serial control timing.

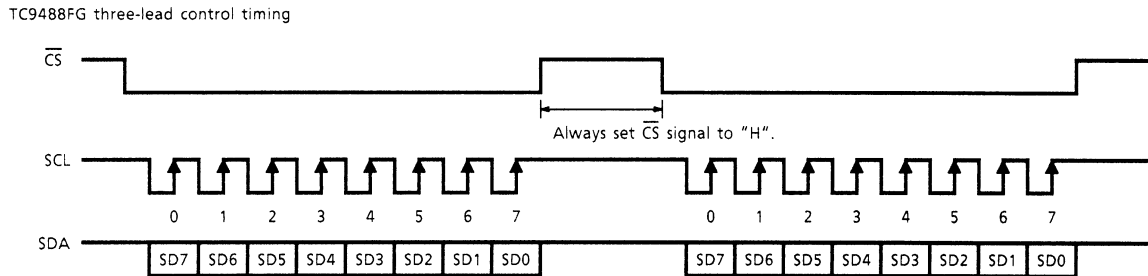

Figure 4 Serial control timing

Table 1 lists bits used to set the volume.

Table 1 Volume setting bits

MODE	DA7	DA6	DA5	DA4	DA3	DA2	DA1	DA0
VOL1 setting	M3	M2	M1	M0	0	0	0	0
VOL2 setting	M3	M2	M1	M0	0	1	0	0
VOL3 setting	M3	M2	M1	M0	1	0	0	0
VOL1, 2, 3 setting	M3	M2	M1	M0	1	1	0	0

M3, M2, M1, M0: Volume setting data

4.2 Setting of microphone and echo volumes

Table 2 lists the microphone setting values and attenuation; Table 3 lists the echo volume setting values and attenuation. The DC level settings are typical values.

Table 2 Microphone volume (VOL1, VOL2) attenuation

DC Level Setting (V)	Serial Data Setting				Attenuation (dB)
	M3	M2	M1	M0	
5.0	0	0	0	0	0
4.4	0	0	0	1	-2
4.2	0	0	1	0	-4
3.9	0	0	1	1	-6
3.7	0	1	0	0	-8
3.5	0	1	0	1	-10
3.2	0	1	1	0	-12
3.0	0	1	1	1	-14
2.7	1	0	0	0	-16
2.5	1	0	0	1	-18
2.3	1	0	1	0	-20
2.0	1	0	1	1	-22
1.8	1	1	0	0	-24
1.5	1	1	0	1	-26
1.3	1	1	1	0	-28
1.1	1	1	1	1	-∞
0.0					

Table 3 Echo volume (VOL3) attenuation

DC Level Setting (V)	Serial Data Setting				Attenuation (dB)
	M3	M2	M1	M0	
5.0	0	0	0	0	0
4.4	0	0	0	1	-1
4.2	0	0	1	0	-2
3.9	0	0	1	1	-3
3.7	0	1	0	0	-4
3.5	0	1	0	1	-5
3.2	0	1	1	0	-6
3.0	0	1	1	1	-7
2.7	1	0	0	0	-8
2.5	1	0	0	1	-9
2.3	1	0	1	0	-10
2.0	1	0	1	1	-11
1.8	1	1	0	0	-12
1.5	1	1	0	1	-13
1.3	1	1	1	0	-14
1.1	1	1	1	1	-∞
0.0					

Maximum Ratings (Ta = 25°C)

Characteristics	Symbol	Rating	Unit
Supply voltage	V _{DD}	-0.3 to 6.0	V
Input voltage	V _{in}	-0.3 to V _{DD} + 0.3	V
Power dissipation	P _D	200	mW
Operating temperature	T _{opr}	-25 to 85	°C
Storage temperature	T _{stg}	-55 to 150	°C

Electrical Characteristics (unless otherwise specified, Ta = 25°C, V_{DD} = 5.0 V)

DC characteristics

Characteristics	Symbol	Test Circuit	Test Condition	Min	Typ.	Max	Unit
Operating supply voltage	V _{DD}	—	Ta = -25~85°C	4.5	5.0	5.5	V
Operating supply current	I _{DD}	—	Fmck = 4 MHz	—	20	30	mA
Operating frequency	Fmck	—	fs = 32 kHz typ.	—	4.0	—	MHz
Power-on reset voltage	V _{por}	—		—	4.0	4.25	V
Input voltage	"H" level	V _{IH}	—	V _{DD} × 0.8	—	V _{DD}	V
	"L" level	V _{IL}	—	0	—	V _{DD} × 0.2	
Input current	"H" level	I _{IH}	—	—	—	1.0	μA
	"L" level	I _{IL}	—	-1.0	—	—	

Volume control (when VOLST = "L")

Characteristics	Symbol	Test Circuit	Test Condition	Min	Typ.	Max	Unit
Hysteresis voltage	V _H	—		—	0.12	—	V
Input step width	V _{ST}	—		—	0.26	—	V
Min level input voltage	V _{Imin}	—		—	1.1	0.8	V
Max level input voltage	V _{Imax}	—		4.95	4.8	—	V

AC Characteristics

Microphone amps and volumes

Characteristics	Symbol	Test Circuit	Test Condition	Min	Typ.	Max	Unit	
Microphone amp gain	MICG	—	Input 1-kHz sine wave, -50dBV, MCO pin measured.	47.5	49.5	51.5	dBV	
MCO Output at ALC Operation	VM	—	Input 1-kHz sine wave, -25dBV.	-0.8	1.7	3.2	dBV	
Maximum Input at No ALC Operation	VL	—	Input 1-kHz sine wave.	—	-47.5	—	dBV	
Maximum Input 1 at ALC Operation	VA1	—	Input 1-kHz sine wave. MCO output clip limit value at max volume	—	-4.0	—	dBV	
Maximum Input 2 at ALC Operation	VA2	—	Input 1-kHz sine wave. MCO output clip limit value at microphone amp output point	—	6.5	—	dBV	
POOUT output noise 1	NO1	—	VOL1~3: min	—	-90	-85	dBV	
POOUT output noise 2	NO2	—	VOL1: max, VOL2: min, VOL3: min	—	-63	-58	dBV	
POOUT output noise 3	NO3	—	VOL1: min, VOL2: max, VOL3: min	—	-64	-59	dBV	
POOUT output noise 4	NO4	—	VOL1: min, VOL2: min, VOL3: max	—	-65	-54	dBV	
POOUT output noise 5	NO5	—	VOL1: max, VOL2: max, VOL3: min	—	-60	-54	dBV	
POOUT output noise 6	NO6	—	VOL1: max, VOL2: min, VOL3: min	—	-62	-54	dBV	
POOUT output noise 7	NO7	—	VOL1: min, VOL2: max, VOL3: max	—	-62	-54	dBV	
POOUT output noise 8	NO8	—	VOL1~3: max	—	-59	-52	dBV	
Volume 1, 2 attenuation	ATT1	—	Ratio with one level higher (excluding the minimum level)	—	-2.0	—	dB	
Volume 3 attenuation	ATT2	—	Ratio with one level higher (excluding the minimum level)	—	-1.0	—	dB	
Attack time	T _{ATK}	—	1 kHz Sine wave input, -20dBV → -10dBV	C = 47 μF (Note 3)	—	120	—	ms
				C = 0.47 μF (Note 3)	—	10	—	
Release time	T _{RLS}	—	1 kHz Sine wave input, -10dBV → -20dBV	C = 47 μF (Note 3)	—	1.6	—	s
				C = 0.47 μF (Note 3)	—	0.15	—	

Note 3: External capacitor of ALC pin

Microcontroller interface (when VOLST = "H")

Characteristics	Symbol	Test Circuit	Test Condition	Min	Typ.	Max	Unit
Interface setup time	t _{IFS}	—		0.25	—	—	μs
Shift clock "L" duration	t _L	—		0.25	—	—	μs
Shift clock "H" duration	t _H	—		0.25	—	—	μs
Data setup time	t _{DS}	—		0.25	—	—	μs
Data hold time	t _{DH}	—		0.25	—	—	μs
Interface hold time	t _{IFH}	—		1.0	—	—	μs
$\overline{\text{CS}}$ "H" duration	t _{CSH}	—		0.25	—	—	μs

AC Characteristics Test Points

TC9488FG three-lead interface

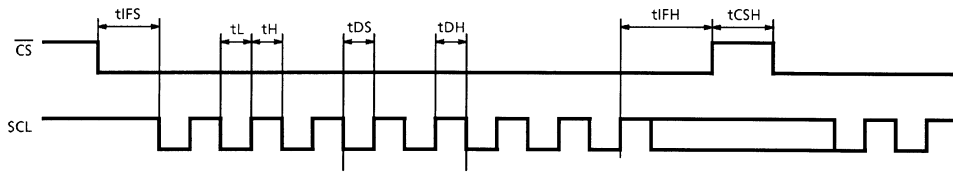

TC9488FG AC Test Circuit

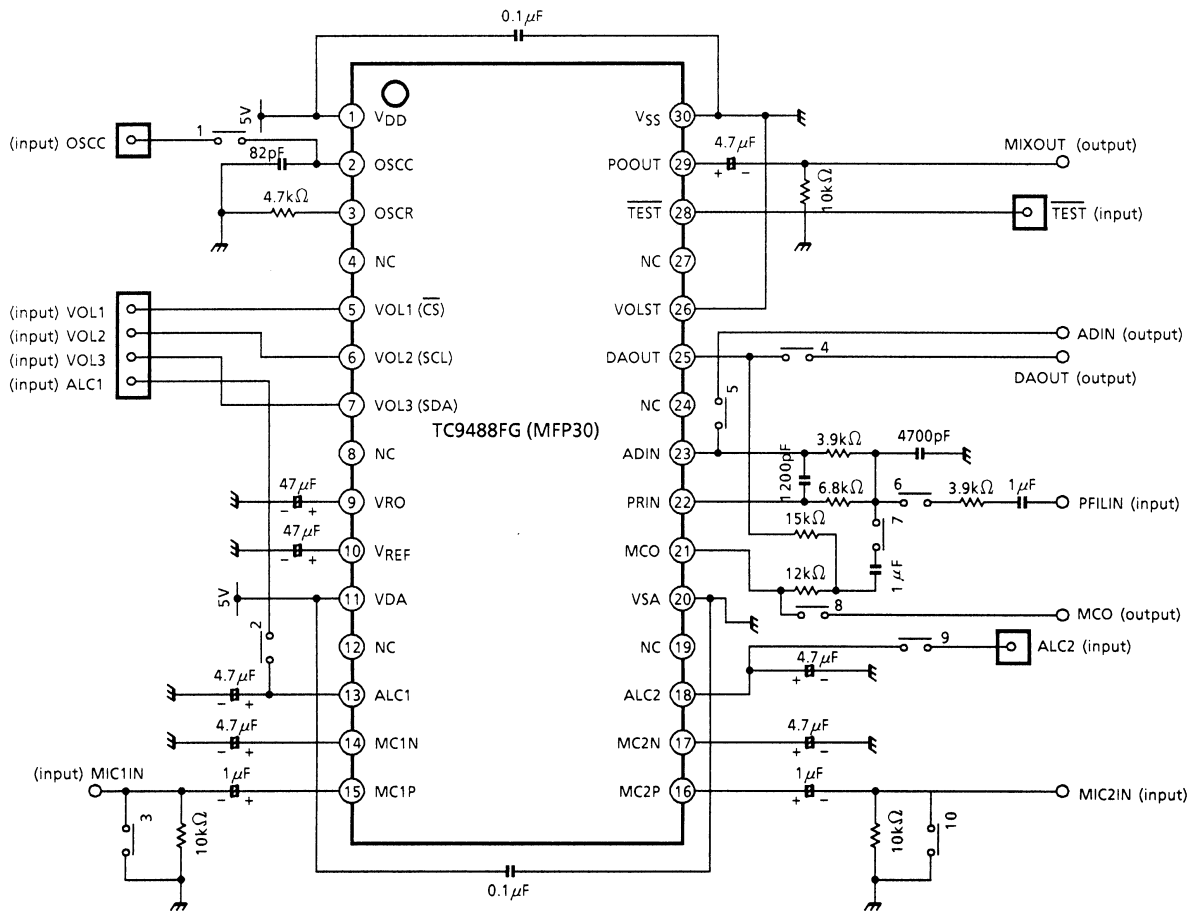

Package Dimensions

SSOP30-P-375-1.00

Unit : mm

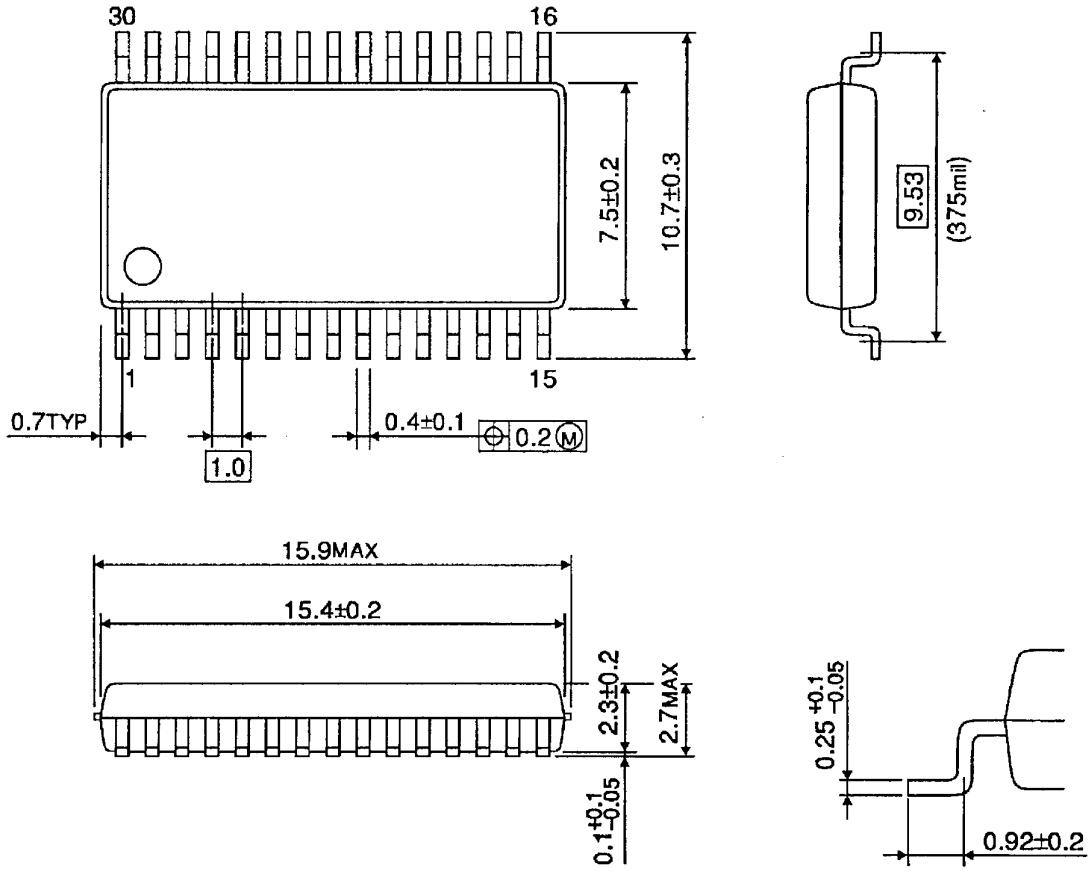

Weight: 1.08 g (typ.)

RESTRICTIONS ON PRODUCT USE

030619EBA

- The information contained herein is subject to change without notice.
- The information contained herein is presented only as a guide for the applications of our products. No responsibility is assumed by TOSHIBA for any infringements of patents or other rights of the third parties which may result from its use. No license is granted by implication or otherwise under any patent or patent rights of TOSHIBA or others.
- TOSHIBA is continually working to improve the quality and reliability of its products. Nevertheless, semiconductor devices in general can malfunction or fail due to their inherent electrical sensitivity and vulnerability to physical stress. It is the responsibility of the buyer, when utilizing TOSHIBA products, to comply with the standards of safety in making a safe design for the entire system, and to avoid situations in which a malfunction or failure of such TOSHIBA products could cause loss of human life, bodily injury or damage to property.
In developing your designs, please ensure that TOSHIBA products are used within specified operating ranges as set forth in the most recent TOSHIBA products specifications. Also, please keep in mind the precautions and conditions set forth in the "Handling Guide for Semiconductor Devices," or "TOSHIBA Semiconductor Reliability Handbook" etc..
- The TOSHIBA products listed in this document are intended for usage in general electronics applications (computer, personal equipment, office equipment, measuring equipment, industrial robotics, domestic appliances, etc.). These TOSHIBA products are neither intended nor warranted for usage in equipment that requires extraordinarily high quality and/or reliability or a malfunction or failure of which may cause loss of human life or bodily injury ("Unintended Usage"). Unintended Usage include atomic energy control instruments, airplane or spaceship instruments, transportation instruments, traffic signal instruments, combustion control instruments, medical instruments, all types of safety devices, etc.. Unintended Usage of TOSHIBA products listed in this document shall be made at the customer's own risk.
- The products described in this document are subject to the foreign exchange and foreign trade laws.
- TOSHIBA products should not be embedded to the downstream products which are prohibited to be produced and sold, under any law and regulations.