

# High-speed switching diode

- . 300mW DO-34
- . Glass silicon switching diodes
- . We declare that the material of product compliance with RoHS requirements.

1SS265

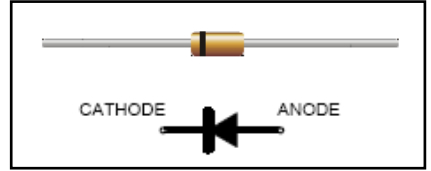

## Product Characteristic

Absolute Maximum Ratings(Ta=25°C)

TYPE	VRM(V)	VR(V)	IO(mA)	P(mW)
1SS265	35	20	100	300

Characteristics at Ta = 25°C

	Symbol	Min.	Typ.	Max.	Unit
Forward Voltage at IF = 10 mA	VF	—	—	1	V
Leakage Current at VR = 20 V	IR	—	—	0.1	μA
Capacitance at VR = 10V f =1MHZ	Ct	—	—	1.5	pF

## Characteristic Curves

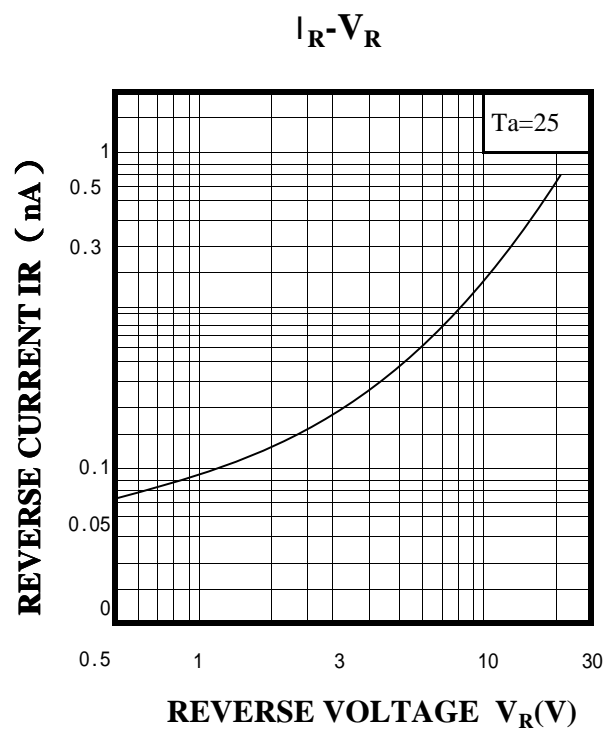
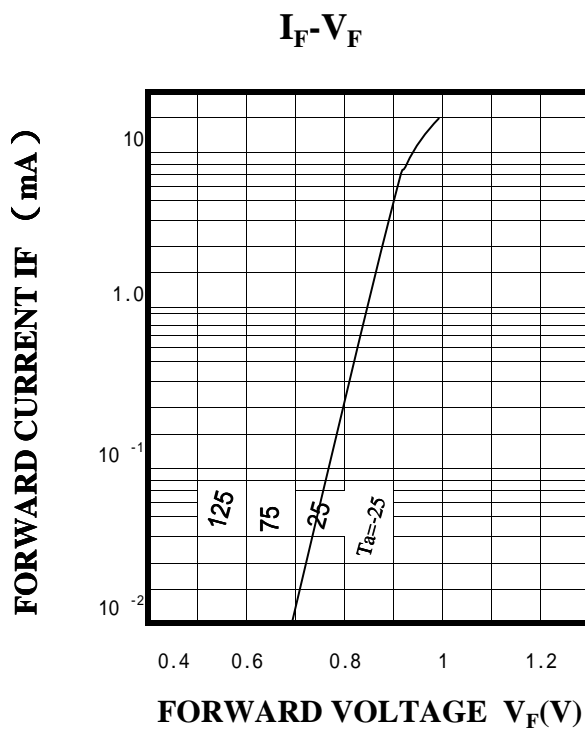

P--Ta

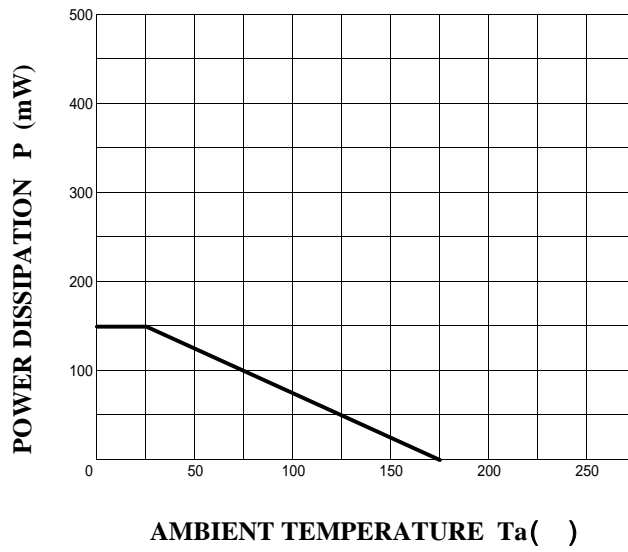

Package Dimensions in inches and (millimeters)

DIM	MILLIMETERS		INCHES	
	MIN	MAX	MIN	MAX
A	2.4	3.0	0.094	0.118
B	1.6	2.0	0.063	0.078
D	0.3	0.5	0.012	0.020
K	28	30	1.102	1.181

D0-34

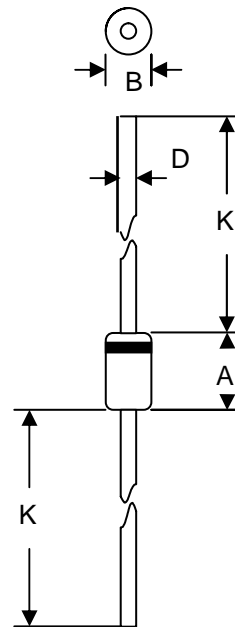

D0-34

## Packing

### Taping / Box(T52)

Tape Inner Box:5000pcs/each

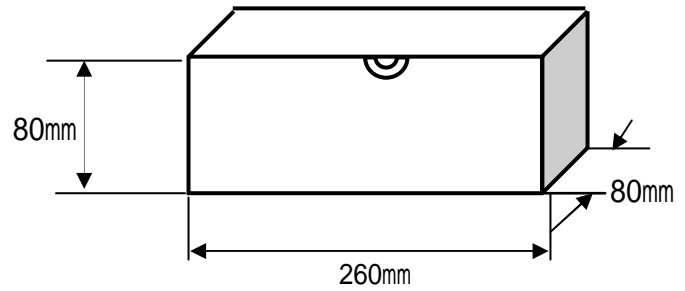

### Taping / Box(T26)

Tape Inner Box:5000pcs/each

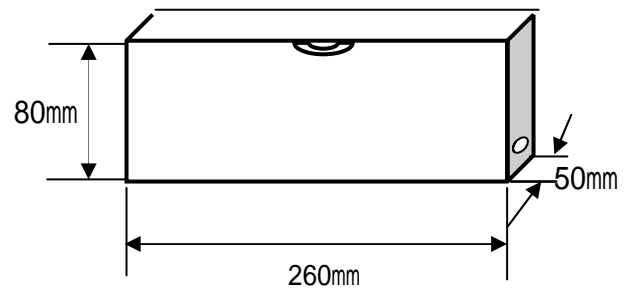

### Bulk

500pcs/bag

10000pcs /each

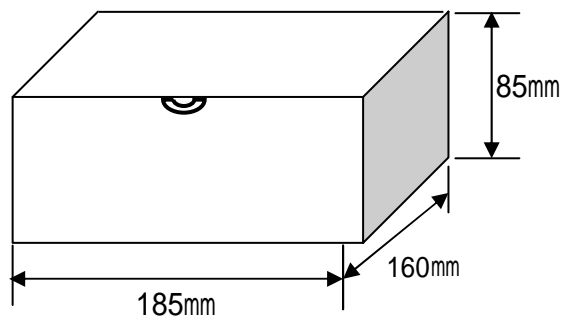

### Reel (T52 )

10000pcs/卷

