

Dual Series Schottky Barrier Diodes

These Schottky barrier diodes are designed for high speed switching applications, circuit protection, and voltage clamping. Extremely low forward voltage reduces conduction loss. Miniature surface mount package is excellent for hand held and portable applications where space is limited.

- Extremely Fast Switching Speed
- Low Forward Voltage — 0.35 Volts (Typ) @ $I_F = 10 \text{ mAdc}$

We declare that the material of product compliance with RoHS requirements.

LBAT54SWT1G

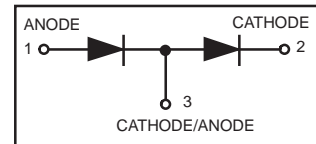
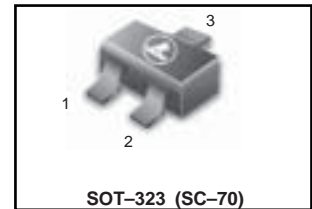

ORDERING INFORMATION

Device	Marking	Shipping
LBAT54SWT1G	B8	3000/Tape & Reel
LBAT54SWT3G	B8	10000/Tape & Reel

DEVICE MARKING

LBAT54SWT1G= B8

MAXIMUM RATINGS (T_J = 125°C unless otherwise noted)

Rating	Symbol	Value	Unit
Reverse Voltage	V _R	30	Volts
Forward Power Dissipation @ T _A = 25°C	P _F	200	mW
Derate above 25°C		1.6	mW/°C
Forward Current(DC)	I _F	200Max	mA
Junction Temperature	T _J	125Max	°C
Storage Temperature Range	T _{stg}	-55 to +150	°C

ELECTRICAL CHARACTERISTICS (T_A = 25°C unless otherwise noted)

Characteristic	Symbol	Min	Typ	Max	Unit
Reverse Breakdown Voltage (I _R = 10 μA)	V _{(BR)R}	30	—	—	Volts
Total Capacitance (V _R = 1.0 V, f = 1.0 MHz)	C _T	—	7.6	10	pF
Reverse Leakage (V _R = 25 V)	I _R	—	0.5	2.0	μAdc
Forward Voltage (I _F = 0.1 mAdc)	V _F	—	0.22	0.24	Vdc
Forward Voltage (I _F = 30 mAdc)	V _F	—	0.41	0.5	Vdc
Forward Voltage (I _F = 100 mAdc)	V _F	—	0.52	1.0	Vdc
Reverse Recovery Time (I _F = I _R = 10 mAdc, I _{R(REC)} = 1.0 mAdc, Figure 1)	t _{rr}	—	—	5.0	ns
Forward Voltage (I _F = 1.0 mAdc)	V _F	—	0.29	0.32	Vdc
Forward Voltage (I _F = 10 mAdc)	V _F	—	0.35	0.40	Vdc
Forward Current (DC)	I _F	—	—	200	mAdc
Repetitive Peak Forward Current	I _{FRM}	—	—	300	mAdc
Non-Repetitive Peak Forward Current (t < 1.0 s)	I _{FSM}	—	—	600	mAdc

LBAT54SWT1G

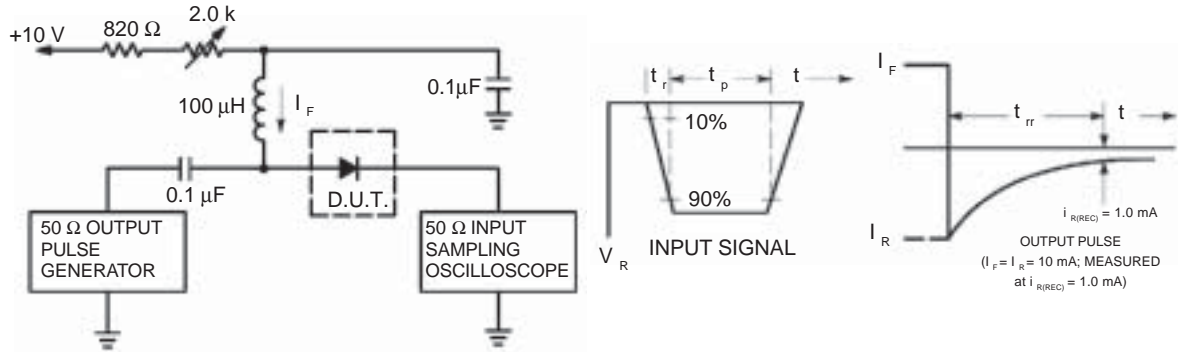

- Notes: 1. A 2.0 kΩ variable resistor adjusted for a Forward Current (I_F) of 10mA.
- 2. Input pulse is adjusted so $I_{R(\text{peak})}$ is equal to 10mA.
- 3. $t_p \gg t_{rr}$

Figure 1. Recovery Time Equivalent Test Circuit

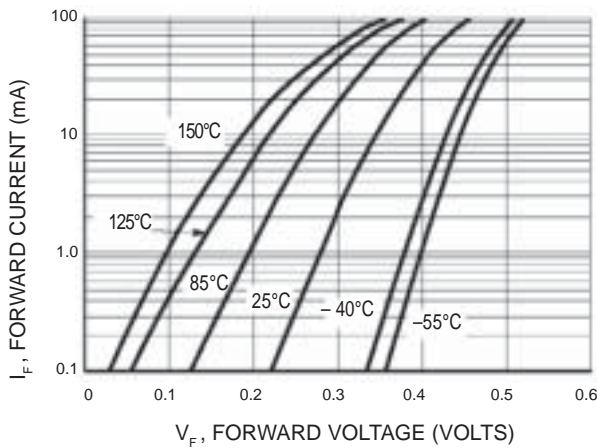

Figure 2. Forward Voltage

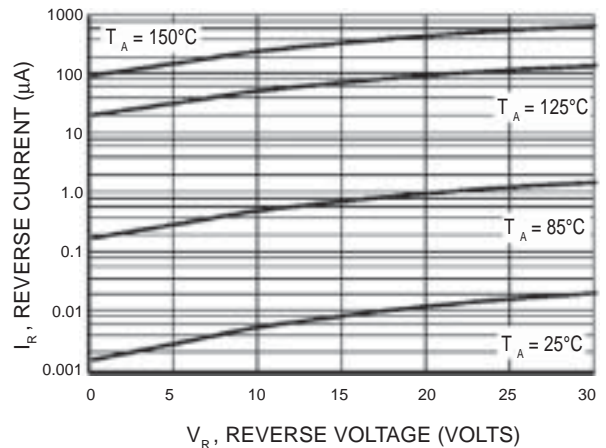

Figure 3. Leakage Current

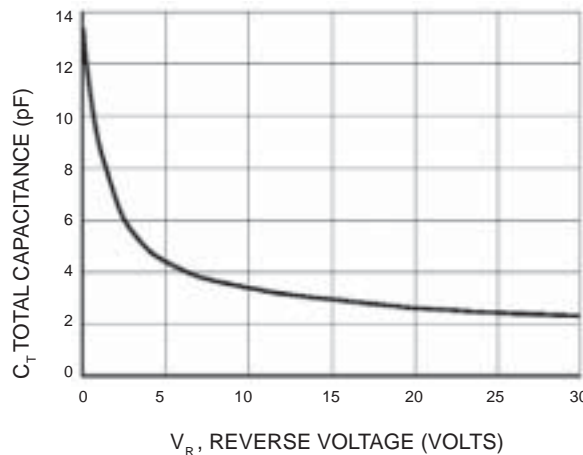
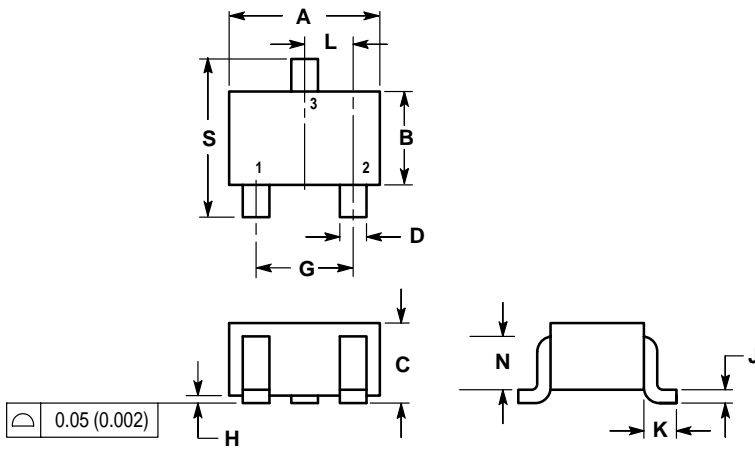

Figure 4. Total Capacitance

LBAT54SWT1G
SC-70 / SOT-323
NOTES:

1. DIMENSIONING AND TOLERANCING PER ANSI Y14.5M, 1982.
2. CONTROLLING DIMENSION: INCH.



DIM	INCHES		MILLIMETERS	
	MIN	MAX	MIN	MAX
A	0.071	0.087	1.80	2.20
B	0.045	0.053	1.15	1.35
C	0.032	0.040	0.80	1.00
D	0.012	0.016	0.30	0.40
G	0.047	0.055	1.20	1.40
H	0.000	0.004	0.00	0.10
J	0.004	0.010	0.10	0.25
K	0.017 REF		0.425 REF	
L	0.026 BSC		0.650 BSC	
N	0.028 REF		0.700 REF	
S	0.079	0.095	2.00	2.40

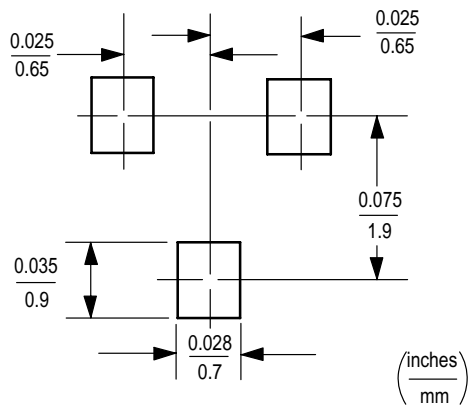

EMBOSSED TAPE AND REEL DATA FOR DISCRETES

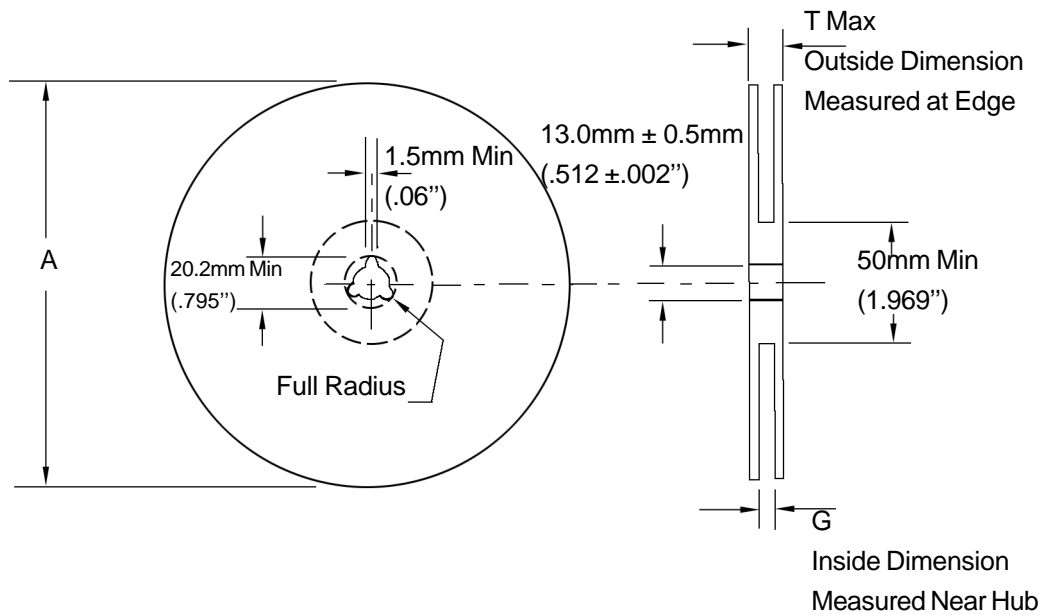

Size	A Max	G	T Max
8 mm	330mm (12.992")	8.4mm+1.5mm, -0.0 (.33"+.059", -0.00)	14.4mm (.56")

Reel Dimensions

Metric Dimensions Govern — English are in parentheses for reference only

Storage Conditions

Temperature: 5 to 40 Deg.C (20 to 30 Deg. C is preferred)

Humidity: 30 to 80 RH (40 to 60 is preferred)

Recommended Period: One year after manufacturing

(This recommended period is for the soldering condition only. The characteristics and reliabilities of the products are not restricted to this limitation)

Shipment Specification

