

SKM 400GB125D

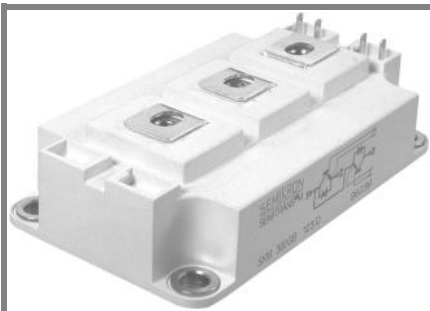

SEMITRANS® 3

Ultra Fast IGBT Modules

SKM 400GB125D

SKM 400GAL125D

SKM 400GAR125D

Features

- Low inductance case
- Short tail current with low temperature dependence
- High short circuit capability, self limiting to $6 \times I_{Cnom}$
- Fast & soft inverse CAL diodes
- Isolated copper baseplate using DBC Direct Copper Bonding Technology
- Large clearance (13 mm) and creepage distances (20 mm)

Typical Applications

- Switched mode power supplies at $f_{sw} > 20\text{kHz}$
- Resonant inverters up to 100 kHz
- Inductive heating
- Electronic welders at $f_{sw} > 20\text{kHz}$

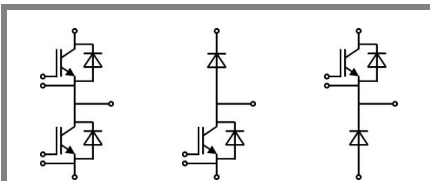

GB

GAL

GAR

Absolute Maximum Ratings		$T_c = 25^\circ\text{C}$, unless otherwise specified			
Symbol	Conditions	Values		Units	
IGBT					
V_{CES}	$T_j = 25^\circ\text{C}$	1200		V	
I_C	$T_j = 150^\circ\text{C}$	$T_{case} = 25^\circ\text{C}$	400	A	
		$T_{case} = 80^\circ\text{C}$	300	A	
I_{CRM}	$I_{CRM} = 2 \times I_{Cnom}$	600		A	
V_{GES}		± 20		V	
t_{psc}	$V_{CC} = 600\text{V}; V_{GE} \leq 20\text{V}; T_j = 125^\circ\text{C}$ $V_{CES} < 1200\text{V}$	10		μs	
Inverse Diode					
I_F	$T_j = 150^\circ\text{C}$	$T_{case} = 25^\circ\text{C}$	390	A	
		$T_{case} = 80^\circ\text{C}$	260	A	
I_{FRM}	$I_{FRM} = 2 \times I_{Fnom}$	600		A	
I_{FSM}	$t_p = 10\text{ms}; \text{sin.}$	$T_j = 150^\circ\text{C}$	2880		A
Freewheeling Diode					
I_F	$T_j = 150^\circ\text{C}$	$T_{case} = 25^\circ\text{C}$	390	A	
		$T_{case} = 80^\circ\text{C}$	260	A	
I_{FRM}	$I_{FRM} = 2 \times I_{Fnom}$	600		A	
I_{FSM}	$t_p = 10\text{ms}; \text{sin.}$	$T_j = 150^\circ\text{C}$	2880		A
Module					
$I_{t(RMS)}$		500		A	
T_{vj}		- 40...+ 150		$^\circ\text{C}$	
T_{stg}		- 40...+ 125		$^\circ\text{C}$	
V_{isol}	AC, 1 min.	4000		V	

Characteristics		$T_c = 25^\circ\text{C}$, unless otherwise specified			
Symbol	Conditions	min.	typ.	max.	Units
IGBT					
$V_{GE(th)}$	$V_{GE} = V_{CE}, I_C = 12\text{mA}$	4,5	5,5	6,5	V
I_{CES}	$V_{GE} = 0\text{V}, V_{CE} = V_{CES}$		0,15	0,45	mA
V_{CE0}		$T_j = 25^\circ\text{C}$	1,4		V
		$T_j = 125^\circ\text{C}$	1,7		V
r_{CE}	$V_{GE} = 15\text{V}$	$T_j = 25^\circ\text{C}$	6,3		$\text{m}\Omega$
		$T_j = 125^\circ\text{C}$	7,6		$\text{m}\Omega$
$V_{CE(sat)}$	$I_{Cnom} = 300\text{A}, V_{GE} = 15\text{V}$	$T_j = 25^\circ\text{C}_{chiplev.}$	3,3	3,85	V
		$T_j = 125^\circ\text{C}_{chiplev.}$	4	4,55	V
C_{ies}	$V_{CE} = 25, V_{GE} = 0\text{V}$	$f = 1\text{MHz}$	22		nF
C_{oes}			3,3		nF
C_{res}			1,2		nF
Q_G	$V_{GE} = 0\text{V} - +20\text{V}$	2650		nC	
R_{Gint}	$T_j = ^\circ\text{C}$	1,25		Ω	
$t_{d(on)}$	$R_{Gon} = 2\Omega$	$V_{CC} = 600\text{V}$ $I_{Cnom} = 300\text{A}$	70		ns
			$T_j = 125^\circ\text{C}$	50	
E_{on}	$R_{Goff} = 2\Omega$	$V_{GE} = \pm 15\text{V}$	17		mJ
$t_{d(off)}$			500		ns
t_f			32		ns
E_{off}			18		mJ
$R_{th(j-c)}$	per IGBT			0,05	K/W

SKM 400GB125D

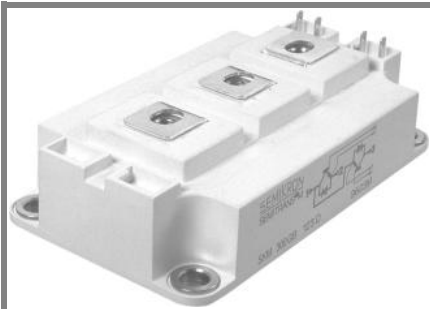

SEMITRANS® 3

Ultra Fast IGBT Modules

SKM 400GB125D

SKM 400GAL125D

SKM 400GAR125D

Features

- Low inductance case
- Short tail current with low temperature dependence
- High short circuit capability, self limiting to $6 \times I_{cnom}$
- Fast & soft inverse CAL diodes
- Isolated copper baseplate using DBC Direct Copper Bonding Technology
- Large clearance (13 mm) and creepage distances (20 mm)

Typical Applications

- Switched mode power supplies at $f_{sw} > 20\text{kHz}$
- Resonant inverters up to 100 kHz
- Inductive heating
- Electronic welders at $f_{sw} > 20\text{ kHz}$

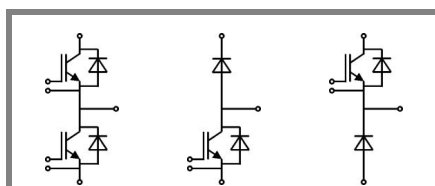

GB

GAL

GAR

Characteristics					
Symbol	Conditions	min.	typ.	max.	Units
Inverse Diode					
$V_F = V_{EC}$	$I_{Fnom} = 300\text{ A}; V_{GE} = 0\text{ V}$	$T_j = 25\text{ }^\circ\text{C}_{chiplev.}$	2	2,5	V
		$T_j = 125\text{ }^\circ\text{C}_{chiplev.}$	1,8		V
V_{F0}		$T_j = 25\text{ }^\circ\text{C}$	1,1	1,2	V
		$T_j = 125\text{ }^\circ\text{C}$			V
r_F		$T_j = 25\text{ }^\circ\text{C}$	3	4,3	mΩ
		$T_j = 125\text{ }^\circ\text{C}$			mΩ
I_{RRM}	$I_{Fnom} = 300\text{ A}$	$T_j = 125\text{ }^\circ\text{C}$	350		A
Q_{rr}	$di/dt = 8300\text{ A}/\mu\text{s}$		45		μC
E_{rr}	$V_{GE} = 0\text{ V}; V_{CC} = 600\text{ V}$		16		mJ
$R_{th(j-c)D}$	per diode			0,125	K/W
Freewheeling Diode					
$V_F = V_{EC}$	$I_{Fnom} = 300\text{ A}; V_{GE} = 0\text{ V}$	$T_j = 25\text{ }^\circ\text{C}_{chiplev.}$	2	2,5	V
		$T_j = 125\text{ }^\circ\text{C}_{chiplev.}$	1,8		V
V_{F0}		$T_j = 25\text{ }^\circ\text{C}$	1,1	1,2	V
		$T_j = 125\text{ }^\circ\text{C}$			V
r_F		$T_j = 25\text{ }^\circ\text{C}$	3	4,3	V
		$T_j = 125\text{ }^\circ\text{C}$			V
I_{RRM}	$I_{Fnom} = 300\text{ A}$	$T_j = 125\text{ }^\circ\text{C}$	350		A
Q_{rr}	$di/dt = 8300\text{ A}/\mu\text{s}$		45		μC
E_{rr}	$V_{GE} = 0\text{ V}; V_{CC} = 600\text{ V}$		16		mJ
$R_{th(j-c)FD}$	per diode			0,125	K/W
Module					
L_{CE}			15	20	nH
$R_{CC'+EE'}$	res., terminal-chip	$T_{case} = 25\text{ }^\circ\text{C}$	0,35		mΩ
		$T_{case} = 125\text{ }^\circ\text{C}$	0,5		mΩ
$R_{th(c-s)}$	per module			0,038	K/W
M_s	to heat sink M6		3	5	Nm
M_t	to terminals M6		2,5	5	Nm
w				325	g

This is an electrostatic discharge sensitive device (ESDS), international standard IEC 60747-1, Chapter IX.

This technical information specifies semiconductor devices but promises no characteristics. No warranty or guarantee expressed or implied is made regarding delivery, performance or suitability.

SKM 400GB125D

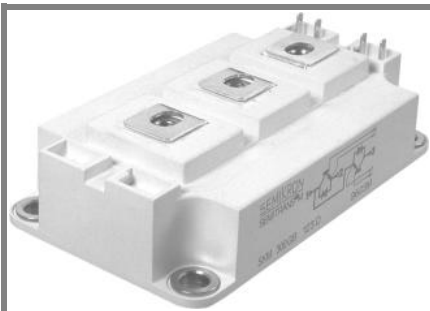

SEMITRANS® 3

Ultra Fast IGBT Modules

SKM 400GB125D

SKM 400GAL125D

SKM 400GAR125D

Features

- Low inductance case
- Short tail current with low temperature dependence
- High short circuit capability, self limiting to $6 \times I_{cnom}$
- Fast & soft inverse CAL diodes
- Isolated copper baseplate using DBC Direct Copper Bonding Technology
- Large clearance (13 mm) and creepage distances (20 mm)

Typical Applications

- Switched mode power supplies at $f_{sw} > 20\text{kHz}$
- Resonant inverters up to 100 kHz
- Inductive heating
- Electronic welders at $f_{sw} > 20\text{ kHz}$

Z_{th}		Conditions	Values	Units
$Z_{th(j-c)I}$				
$R_{\theta j-c}$	$i = 1$		36	mk/W
$R_{\theta j-c}$	$i = 2$		10,5	mk/W
$R_{\theta j-c}$	$i = 3$		3	mk/W
$R_{\theta j-c}$	$i = 4$		0,5	mk/W
$\tau_{th(j-c)}$	$i = 1$		0,0744	s
$\tau_{th(j-c)}$	$i = 2$		0,0078	s
$\tau_{th(j-c)}$	$i = 3$		0,0016	s
$\tau_{th(j-c)}$	$i = 4$		0,0002	s
$Z_{th(j-c)D}$				
$R_{\theta j-c}$	$i = 1$		75	mk/W
$R_{\theta j-c}$	$i = 2$		38	mk/W
$R_{\theta j-c}$	$i = 3$		10,6	mk/W
$R_{\theta j-c}$	$i = 4$		1,4	mk/W
$\tau_{th(j-c)}$	$i = 1$		0,0386	s
$\tau_{th(j-c)}$	$i = 2$		0,0201	s
$\tau_{th(j-c)}$	$i = 3$		0,001	s
$\tau_{th(j-c)}$	$i = 4$		0,003	s

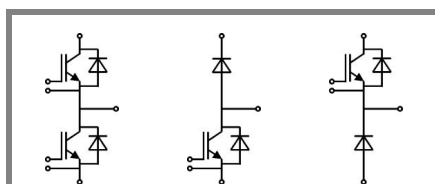

GB

GAL

GAR

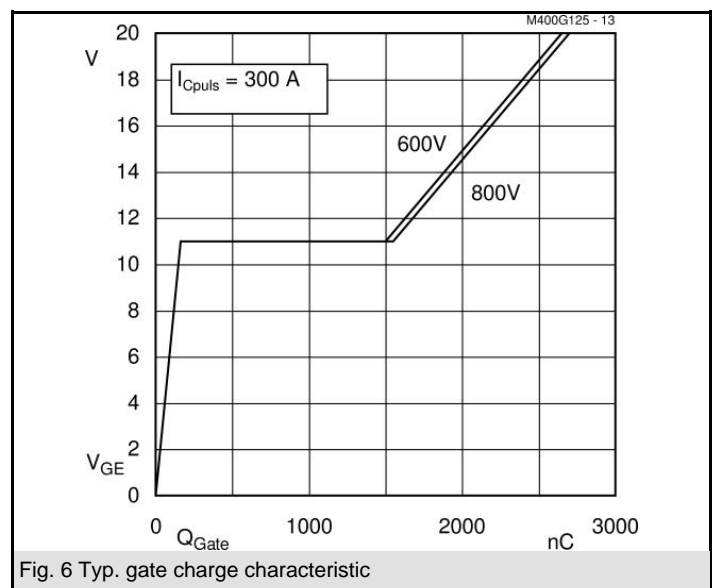
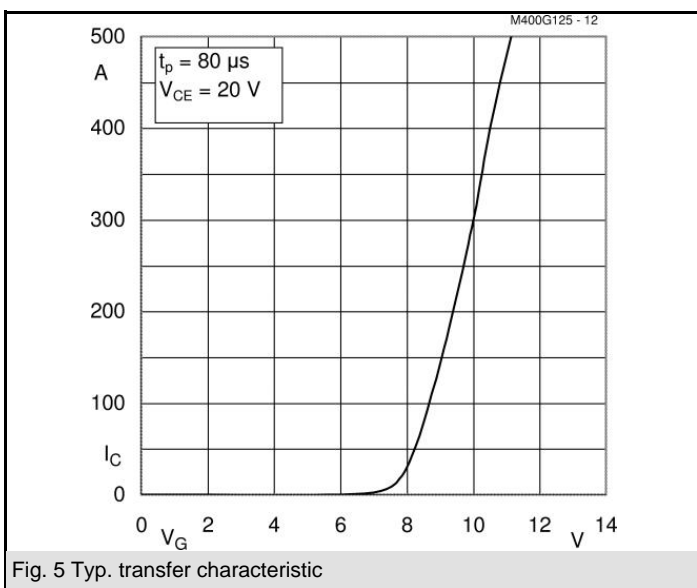
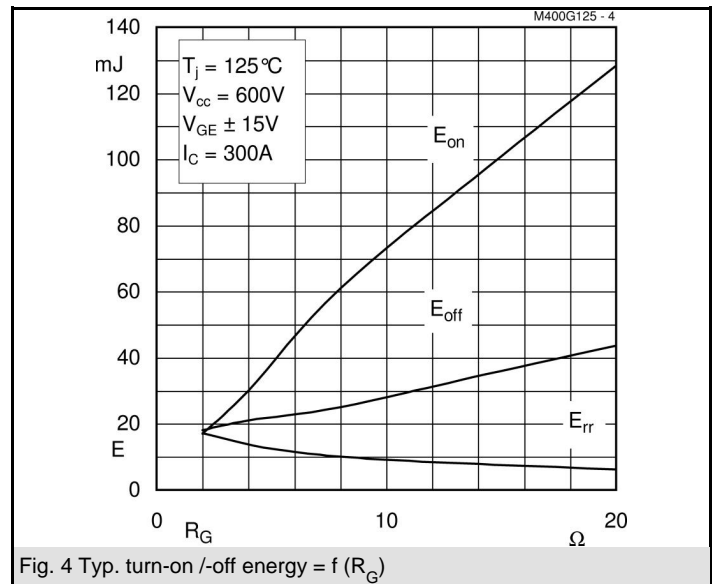
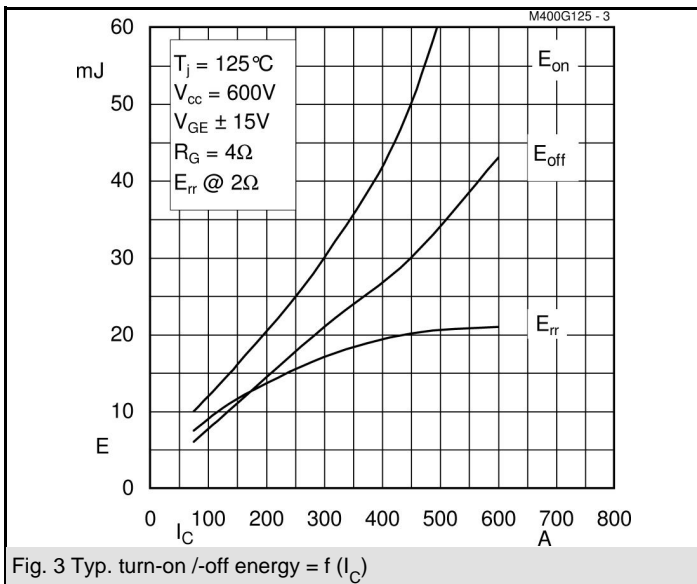
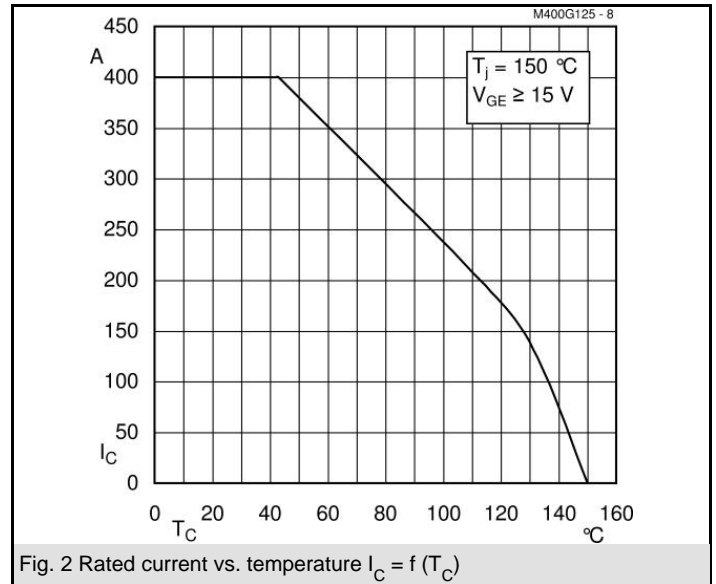
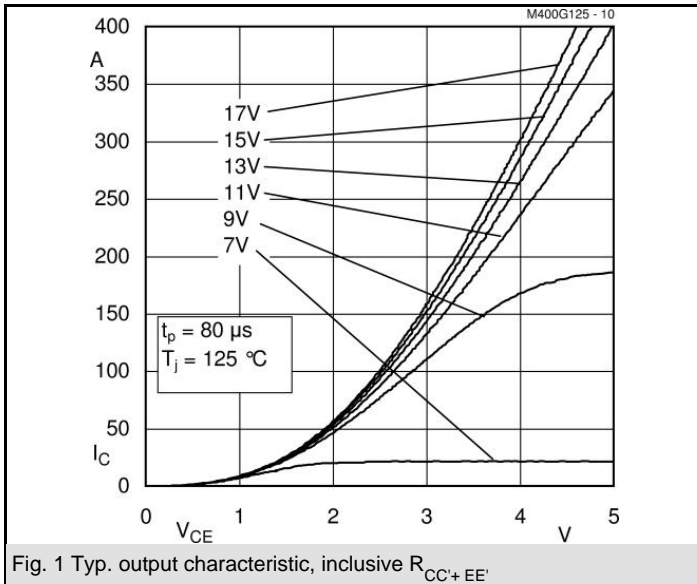

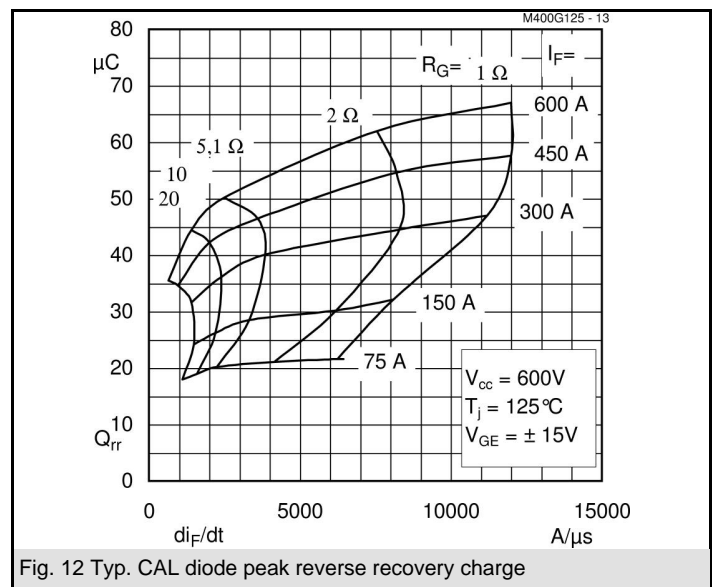
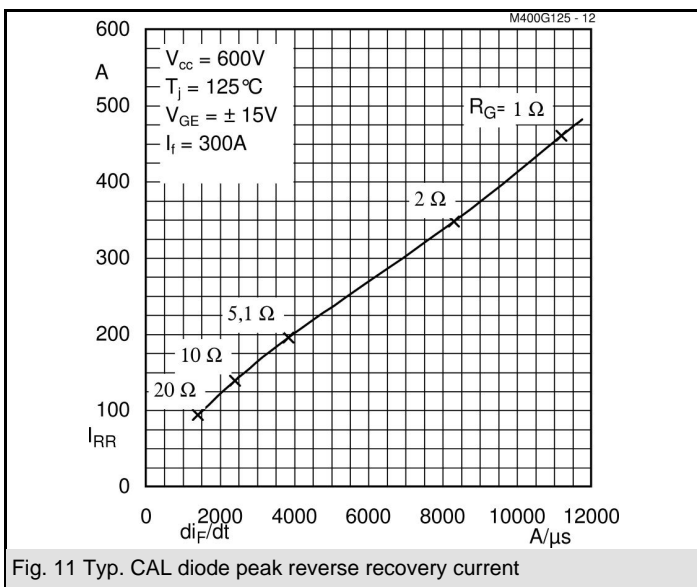
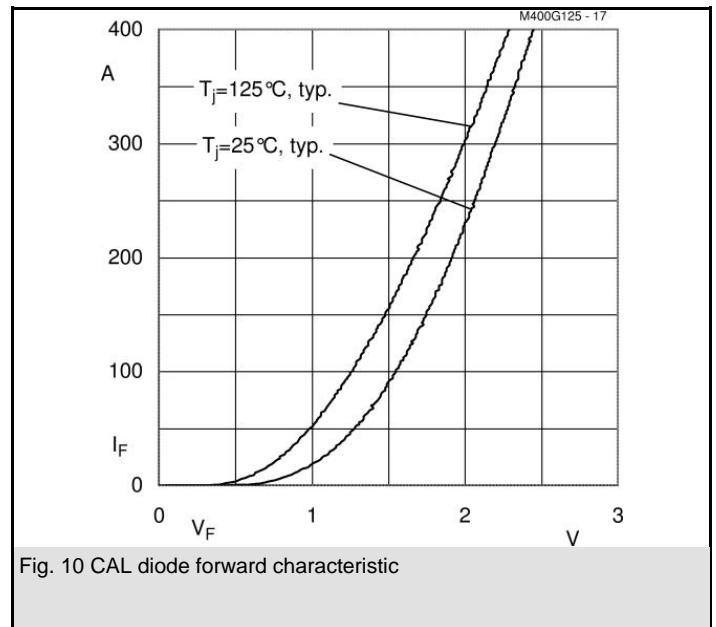
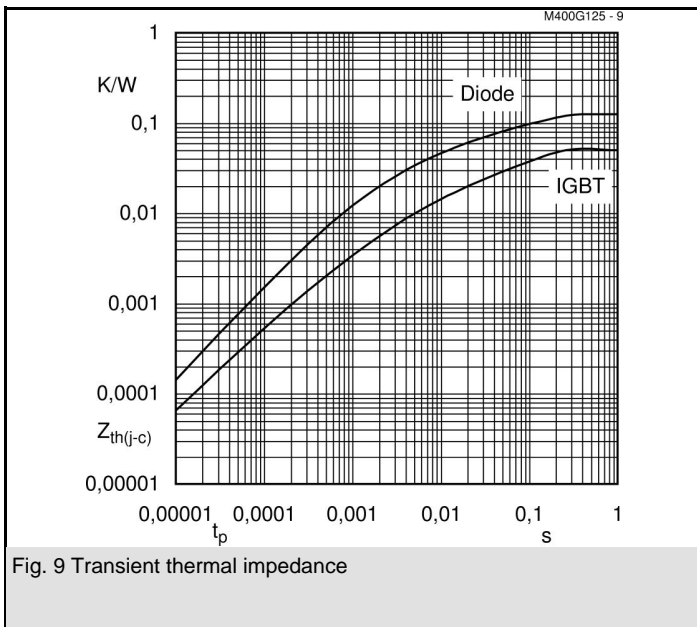
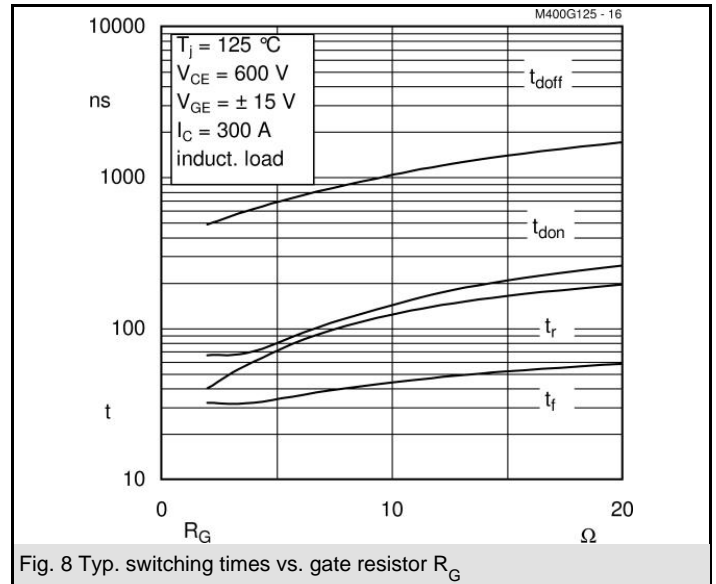
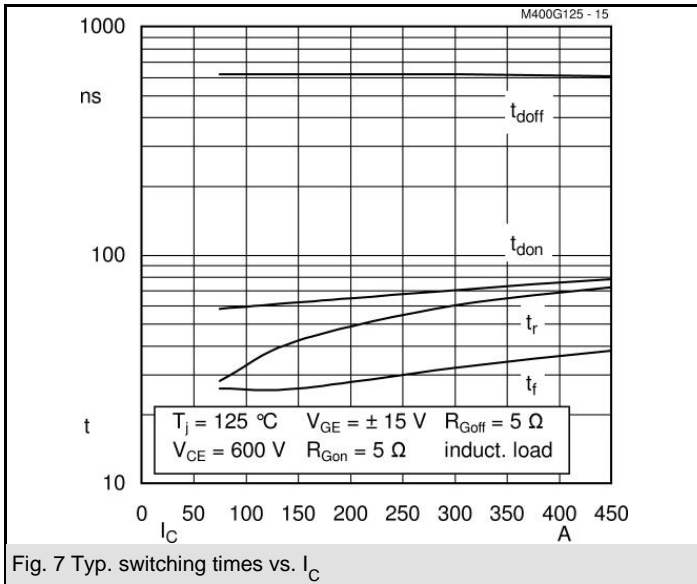

SKM 400GB125D

UL Recognized

CASED56

File 63 532

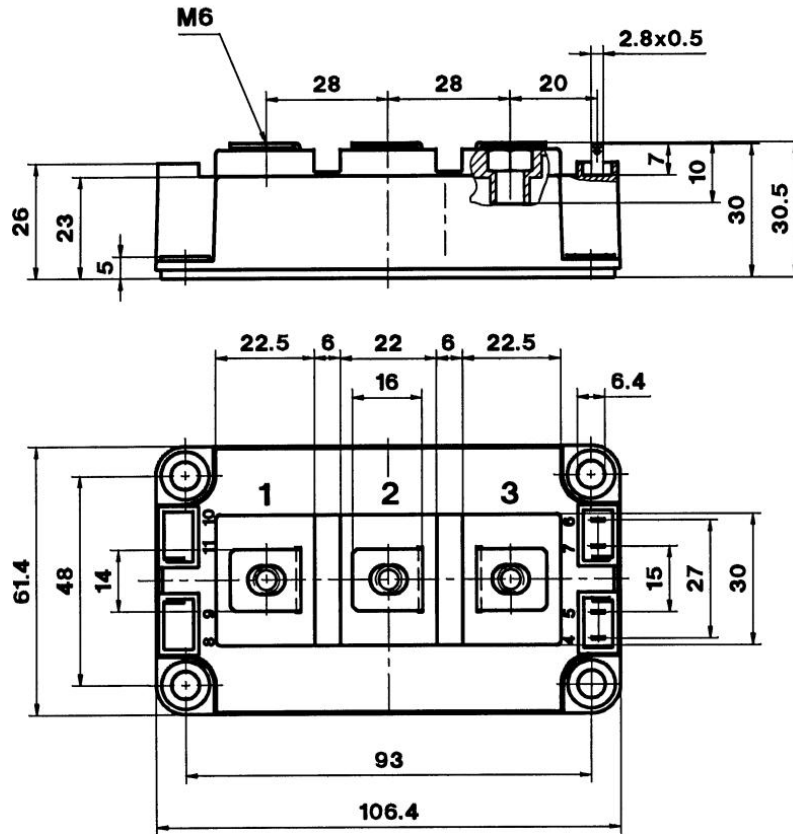

Case D 56

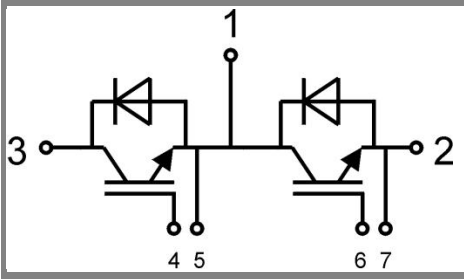

GB

Case D 56

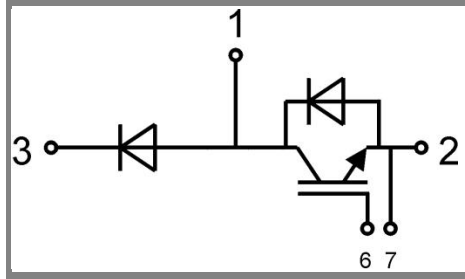

GAL

Case D 57 (→ D 56)

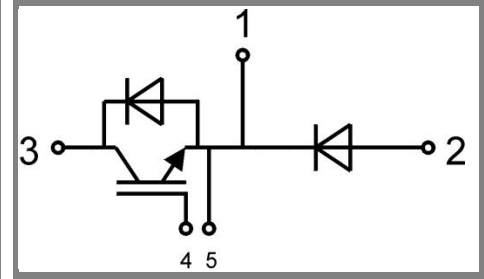

GAR

Case D 58 (→ D 56)