

Intel® TXN31015D2 Quad-Rate 850 nm Optical Transceiver - SFF* MSA Compatible

Datasheet

The Intel® LC Small Form Factor (SFF) optical transceivers are high-performance integrated modules for bi-directional communication over Multimode optical fiber.

The Intel® TXN31015D2 Quad-Rate 850 nm Optical Transceiver (called hereafter the TXN31015D2 Optical Transceiver) is specifically designed for high-speed Fibre Channel data links at 4.25 Gbps (4x Fibre Channel rate). The TXN31015D2 Optical Transceiver is also backwards compatible with 2x and 1x Fibre Channel and Gigabit Ethernet rates.

The TXN31015D2 Optical Transceiver has an LC receptacle compatible with the industry-standard LC connector. The TXN31015D2 Optical Transceiver is Class 1 laser safety compliant with FDA Radiation Performance Standards, 21 CFR 1040.10, and international standards IEC 60825-1 and IEC 60825-2.

Product Features

- Compliant with the Fibre Channel FC-P1 Standard
- 4.25/2.125/1.0625 Gbps Fibre Channel and 1.25 Gbps Ethernet Compatible
- Compatible with the SFF Multisource Agreement (MSA) Specification
- 850 nm VCSEL emitter
- TTL Signal Detect Output
- Transmitter Disable Input
- AC-coupled CML Level Input/Output
- Single +3.3 V Power Supply
- Class 1 Laser Safety Product
- IEC/UL 60950-1 Safety Certified
- Designed and verified as RoHS 6 compliant
- China RoHS compliant with 30-year EFUP
- Digital Diagnostics Support

Applications

- Fibre Channel Host Bus Adapters
- Ethernet Network Interface Cards
- iSCSI Host Bus Adapters



INFORMATION IN THIS DOCUMENT IS PROVIDED IN CONNECTION WITH INTEL® PRODUCTS. NO LICENSE, EXPRESS OR IMPLIED, BY ESTOPPEL OR OTHERWISE, TO ANY INTELLECTUAL PROPERTY RIGHTS IS GRANTED BY THIS DOCUMENT. EXCEPT AS PROVIDED IN INTEL'S TERMS AND CONDITIONS OF SALE FOR SUCH PRODUCTS, INTEL ASSUMES NO LIABILITY WHATSOEVER, AND INTEL DISCLAIMS ANY EXPRESS OR IMPLIED WARRANTY, RELATING TO SALE AND/OR USE OF INTEL PRODUCTS INCLUDING LIABILITY OR WARRANTIES RELATING TO FITNESS FOR A PARTICULAR PURPOSE, MERCHANTABILITY, OR INFRINGEMENT OF ANY PATENT, COPYRIGHT OR OTHER INTELLECTUAL PROPERTY RIGHT. Intel products are not intended for use in medical, life saving, life sustaining, critical control or safety systems, or in nuclear facility applications.

Intel may make changes to specifications and product descriptions at any time, without notice.

Intel Corporation may have patents or pending patent applications, trademarks, copyrights, or other intellectual property rights that relate to the presented subject matter. The furnishing of documents and other materials and information does not provide any license, express or implied, by estoppel or otherwise, to any such patents, trademarks, copyrights, or other intellectual property rights.

Designers must not rely on the absence or characteristics of any features or instructions marked "reserved" or "undefined." Intel reserves these for future definition and shall have no responsibility whatsoever for conflicts or incompatibilities arising from future changes to them.

Intel processor numbers are not a measure of performance. Processor numbers differentiate features within each processor family, not across different processor families. See http://www.intel.com/products/processor_number for details.

The Intel® TXN31015D2 Quad-Rate 850 nm Optical Transceiver - SFF* MSA Compatible may contain design defects or errors known as errata which may cause the product to deviate from published specifications. Current characterized errata are available on request. Contact your local Intel sales office or your distributor to obtain the latest specifications and before placing your product order.

Copies of documents which have an order number and are referenced in this document, or other Intel literature may be obtained by calling 1-800-548-4725 or by visiting Intel's website at <http://www.intel.com>.

Intel and the Intel logo are trademarks of Intel Corporation in the U.S. and other countries.

*Other names and brands may be claimed as the property of others.

Copyright © 2007, Intel Corporation. All Rights Reserved.



Contents

1.0	Introduction	7
2.0	Specifications	8
2.1	Maximum Ratings and Recommended Operating Conditions	8
2.2	Electrical Characteristics	9
3.0	Electrical Interface	12
4.0	Termination	15
4.1	Types of I/O Interfaces	15
4.2	CML Termination	15
5.0	SFF Timing Parameters	17
6.0	Digital Diagnostic Monitoring Interface	18
6.1	Overview of Digital Diagnostic Monitoring Interface	18
6.2	General Memory Map Descriptions	19
6.3	Alarm and Warning Fields for 2-Wire Interface Address A2h	20
6.4	A/D Fields for 2-Wire Interface Address A2h	22
7.0	Grounding Scheme	22
8.0	Mechanical Specification	25
9.0	Regulatory Compliance	27
9.1	Electromagnetic Compatibility Compliance	27
9.2	Safety Compliance	28
9.3	Lead-Free Conformance	29
9.4	Compliance with Restriction of Hazardous Substances (RoHS)	29
9.5	Management Methods on Control of Pollution from Electronic Information Products (a.k.a. China RoHS)	30
9.6	Product Certification Markings and Compliance Statements	31
10.0	Ordering Information	32
11.0	Acronyms	33
Figures		
	Pin Layout	14
2	Circuit Diagram for CML Termination on Receiver Output	15
3	Circuit Diagram for CML Termination on Transmitter Input	16
4	Grounding Application Diagram for Intel® TXN31015D2 Optical Transceiver	24
5	SFF Mechanical Specifications	26



Tables

1	Absolute Maximum Ratings	8
2	Recommended Operating Conditions	8
3	Electrical Characteristics – Power and Current	9
4	Electrical Characteristics – Transmitter	9
5	Electrical Characteristics – Receiver	10
6	Electrical Characteristics – 2-Wire Interface	10
7	Fiber Length Specifications	10
8	Optical Specifications – Transmitter	11
9	Optical Specifications – Receiver	11
10	Pin Assignment	12
11	Timing Parameters for SFF Management	17
12	Memory Map – 2-Wire Address Range Descriptions	19
13	Alarm and Warning Fields – 2-Wire Address A2h, Address 0-95	20
14	A/D Fields – 2-Wire Address A2h, Addresses 96-109	22
15	A/D Status/Control Bits – 2-Wire Address A2h, Address 110	22
16	Electromagnetic Compatibility Compliance	26
17	Safety Compliance	27
18	Lead-Free 2 nd -Level Interconnect Markings	28
19	Hazardous Substances Table	29
20	Product Certification Markings and Compliance Statements	30
21	Ordering Information	31
22	Acronyms	32



Revision History

Date	Revision	Description
18-April-2007	001	Initial release of document



Intel® TXN31015D2 Quad-Rate 850 nm Optical Transceiver - SFF MSA Compatible*



1.0 Introduction

The Intel® TXN31015D2 Quad-Rate 850 nm Optical Transceiver - SFF* MSA Compatible (called hereafter the TXN31015D2 Optical Transceiver) is specifically designed for high-speed Fibre Channel data links at 4.25 Gbps (4x Fibre Channel rate).

This document discusses the following TXN31015D2 Optical Transceiver topics:

- [Section 2.0, "Specifications" on page 8](#)
- [Section 3.0, "Electrical Interface" on page 12](#)
- [Section 4.0, "Termination" on page 15](#)
- [Section 5.0, "SFF Timing Parameters" on page 17](#)
- [Section 6.0, "Digital Diagnostic Monitoring Interface" on page 18](#)
- [Section 8.0, "Mechanical Specification" on page 25](#)
- [Section 9.0, "Regulatory Compliance" on page 27](#)
- [Section 10.0, "Ordering Information" on page 32](#)
- [Section 11.0, "Acronyms" on page 33](#)

For information on standards that apply to the TXN31015D2 Optical Transceiver, see the following references:

- "Diagnostic Monitoring Interface for Optical Xcvrs". SFF Document Number SFF-8472, Revision 9.3.
- IEEE Std 802.3, 2002 Edition, Clause 38, PMD Type 1000BASE-SX. IEEE Standards Department, 2002
- IEEE Std 802.3z, 1998 Edition. Gigabit Interface Converter (GBIC) Ethernet Standard.
- Small Form-Factor (SFF) Transceiver Multisource Agreement (MSA)
- Telcordia Technologies* GR-63 Section 4.2



2.0 Specifications

Specifications include the following:

- Section 2.1, “Maximum Ratings and Recommended Operating Conditions” on page 8
- Section 2.2, “Electrical Characteristics” on page 9
- Section , “Table 5 lists the TXN31015D2 Optical Transceiver receiver electrical characteristics. Table 6 lists the TXN31015D2 Optical Transceiver 2-Wire Interface electrical characteristics. Optical Specifications” on page 10

2.1 Maximum Ratings and Recommended Operating Conditions

Table 1 lists the absolute maximum ratings for the TXN31015D2 Optical Transceiver.

Table 1. Absolute Maximum Ratings

Parameter	Symbol	Min	Typ	Max	Units	Notes
Storage Temperature	T _s	-40	–	85	°C	–
Relative Humidity	RH	5	–	95	%	–
Soldering Temperature	–	–	–	260	°C	10 seconds on leads only
Supply Voltage	V _{cc} T, R	-0.5	–	4	V	–
Data AC Voltage	TD+ and TD-	–	–	2.2	V _{pp}	Differential
Control Input Voltage	V _i	-0.5	–	V _{cc} + 0.3	V	–
Caution: Exceeding these values may cause permanent damage. Functional operation under these conditions is not implied.						

Table 2 lists the recommended operating conditions. (Minimum and maximum values listed in Table 3 through Table 9 apply over the recommended operating conditions specified in Table 2.)

Table 2. Recommended Operating Conditions

Parameter	Symbol	Min	Typ	Max	Units
Case Temperature	T _c	-20	–	85	°C
Supply Voltage	V _{cc} T, R	2.97	3.3	3.63	VDC
Data Rate	–	1.0625	–	4.25	Gbps



2.2 Electrical Characteristics

The minimum and maximum values in this section apply over the following recommended temperature and voltage range (from Table 2, "Recommended Operating Conditions" on page 8).

$$-20\text{ }^{\circ}\text{C} < T_c < 85\text{ }^{\circ}\text{C}, 3.0\text{ V} < V_{cc} < 3.6\text{ V}$$

Table 3 lists the TXN31015D2 Optical Transceiver electrical characteristics for power and current.

Table 3. Electrical Characteristics – Power and Current

Parameter	Symbol	Min	Typ	Max	Units	Notes
Supply Current	I_{cc}	–	170		mA	$T_c = 20^{\circ}\text{C}$, $V_{cc} = 3.3\text{ V}$
			–	220	mA	–
Power Dissipation	P_{diss}	–	565	800	mW	–
Supply Noise Rejection	–	100	–	–	mV	10 kHz to 4 MHz with supply filter

Table 4 lists the TXN31015D2 Optical Transceiver transmitter electrical characteristics.

Table 4. Electrical Characteristics – Transmitter

Parameter	Symbol	Min	Typ	Max	Units	Notes
CML Input (Single Ended)	–	250	–	1100	mVpp	AC coupled inputs
CML Input (Differential)	–	500	–	2200	mVpp	Peak-to-peak voltage
Input Impedance (differential)	Z_{IN}	85	100	115	Ω	–
TX_DISABLE input voltage - High	V_{IH}	2	–	$V_{cc} + 0.3$	V	–
TX_DISABLE input voltage - Low	V_{IL}	0	–	0.6	V	–
TX_Fault Output Voltage - High	V_{OH}	2.0	–	$V_{cc} + 0.3$	V	$I_{OH} = 40\text{ }\mu\text{A}$, 1 TTL Unit Load
TX_Fault Output Voltage - Low	V_{OL}	0	–	0.8	V	$I_{OL} = -1.6\text{ mA}$, 1 TTL Unit Load



Table 5 lists the TXN31015D2 Optical Transceiver receiver electrical characteristics.

Table 5. Electrical Characteristics – Receiver

Parameter	Symbol	Min	Typ	Max	Units	Notes
CML Output (Single Ended)	–	250	300	500	mVpp	AC-coupled outputs
CML Output (Differential)	–	500	600	1000	mVpp	Peak-to-peak voltage
CML Output rise/fall time	–	–	–	115	ps	20% - 80%
Output Impedance (differential)	Zout	85	100	115	Ω	–
TTL Signal Detect Output - Low	–	0	–	0.8	V	I _{OL} = -1.6 mA, 1 TTL Unit Load
TTL Signal Detect Output - High	V _{OH}	2.0	–	V _{CC} + 0.3	V	I _{OL} = 40 μA, 1 TTL Unit Load
Deterministic Jitter	DJ	–	–	28.2	ps	–
Total Jitter	TJ	–	–	61.7	ps	–

Table 6 lists the TXN31015D2 Optical Transceiver 2-Wire Interface electrical characteristics. Optical Specifications

Table 6. Electrical Characteristics – 2-Wire Interface

Parameter	Symbol	Min	Typ	Max	Units	Notes
MOD_DEF (0:2)	V _{OH}	2.5	–	V _{CC} + 0.3	V	With Serial ID
	V _{OL}	0	–	0.5	V	–
	NC	100 K	–	–	Ω	Measured to RGND/ TGND

Table 7 lists the TXN31015D2 Optical Transceiver fiber length specifications.

Table 7. Fiber Length Specifications

Parameter	Symbol	Min	Typ	Max	Units	Notes
Data rate	BR		1.0625, 1.25, 2.125, 4.25		Gbps	1
Bit Error Rate	BER			10 ⁻¹²		5
50 μm/125 μm MMF	L	2	–	500	m	2
				300		3
				150		4
62.5 μm/125 μm MMF	L	2	–	300	m	2
				150		3
				70		4

NOTES:
 1. 1000BASE-SX compatible per IEEE802.3 and 1x, 2x, and 4x Fibre Channel compatible per FC-PI-2
 2. Data rates at 1000BASE-SX Gigabit Ethernet and 1.0625 Gbps
 3. Data rates at 2.125 Gbps Fibre Channel.
 4. Data rate at 4.25 Gbps Fibre Channel.
 5. Data rate at 4.25 Gbps with 2⁷ - 1 PRBS pattern.

Table 8 lists the TXN31015D2 Optical Transceiver transmitter optical specifications.



Table 8. Optical Specifications – Transmitter

Parameter	Symbol	Min	Typ	Max	Units	Notes
Optical Transmit Power (50 or 62.5 μ m MMF)	Popt	-8	-5	-1.1	dBm	Average launch power
Optical Center Wavelength		830	850	860	nm	–
Spectral Width	–	–	–	0.85	nm	RMS
Optical Modulation Amplitude	OMA	247	–	–	μ W	pk-pk
Relative Intensity Noise	RIN	–	–	-118	dB/Hz	–
Deterministic Jitter	DJ			28.2	ps	–
Total Jitter	TJ	–	–	59.8	ps	–
Output Rise/Fall Time	tR, tF	–	–	90	ps	20 - 80% values, measured unfiltered
Eye Mask: Compliant with eye mask requirements of Fibre Channel – Physical Interfaces (FC-PI-2) specifications, IEEE 802.3z* Gigabit Ethernet 1000 BASE-SX standard						

Table 9 lists the TXN31015D2 Optical Transceiver receiver optical specifications.

Table 9. Optical Specifications – Receiver

Parameter	Symbol	Min	Typ	Max	Units	Notes
Optical Input Wavelength	–	770	–	860	nm	–
Receiver Sensitivity	Pr	-18	-20	–	dBm	1.0625 and 2.125 Gbps Test conditions: • 10^{-12} BER • 9 dB ER input • $2^7 - 1$ PRBS
		-16	-18	–	dBm	4.25 Gbps Test conditions: • 10^{-12} BER • 9 dB ER input • $2^7 - 1$ PRBS
Stressed Sensitivity	Compliant with Fibre Channel – Physical Interfaces (FC-PI-2) specifications, IEEE 802.3z Gigabit Ethernet 1000 BASE-SX standard					
Receiver Overload	–	–	–	0	dBm	–
Optical Return Loss	ORL	12	30	–	dB	–
Signal Detect - Asserted	Pa	–	–	-17	dB	Measured on transition - low to high
Signal Detect - De-asserted	Pd	-29	–	–	dBm	Measured on transition - high to low
Signal Detect - Hysteresis	Pa - Pd	1	–	5	dB	–



3.0 Electrical Interface

Table 10 lists the pin assignment and function descriptions.

Table 10. Pin Assignment (Sheet 1 of 2)

Pin Number	Pin Name	Pin Function	Note
1	VeeR	Receiver Signal ground	Note 1
2	VccR	Receiver +3.3 V Power Supply	Note 2
3	SD	Signal Detect TTL output	Note 3
4	RD-	Receiver CML Inverted Data output	Note 4
5	RD+	Receiver CML Data output	Note 4
6	VccT	Transmitter +3.3 V Power Supply	Note 2
7	VeeT	Transmitter Signal Ground	Note 1
8	TDis	Transmit Disable TTL input	Note 5
9	TD+	Transmit CML Data input	Note 6
10	TD-	Transmit Inverted CML Data input	Note 6
A	MOD-DEF[2]	2-Wire Serial data TTL input	Note 7
B	MOD-DEF[1]	2-Wire Serial Clock TTL input	Note 7



Table 10. Pin Assignment (Sheet 2 of 2)

Pin Number	Pin Name	Pin Function	Note
C	–	Not used	–
D	Transmit Fault Indication	Tx Fault output	Note 8

NOTES:

- VeeR and VeeT are the signal grounds, there 2 grounds are internally separated within the SFF module.
- V_{cc}R and V_{cc}T are the receiver and transmitter power supplies. Their values, which are listed in Table 2, “Recommended Operating Conditions” on page 8, are defined at the SFF pin assignment. Maximum supply current is listed in Table 3, “Electrical Characteristics – Power and Current” on page 9.
- SD (Signal Detect) is a TTL output and has an internal 10K pull-up resistor to VccR.
 - When low, this output indicates the received optical power is below the worst-case receiver sensitivity. In the low state, the output is pulled to < 0.8V.
 - When high, this output indicates normal operation (as defined by the standard in use).
- RD-/± are the differential receiver outputs. They are AC-coupled 100 W differential lines that are terminated with 100 W (differential) at the user SerDes. The AC coupling is performed inside the TXN31015D2 Optical Transceiver and is therefore not required on the host board.
- TX DISABLE is a TTL input used to shut down the transmitter optical output. The states are as follows:
 - Low (0 - 0.6 V): Transmitter Enabled
 - (>0.8, <2.0 V): Undefined
 - High (2.0 - 3.465 V): Transmitter Disabled
- TD-/± are the differential transmitter inputs. They are AC-coupled differential lines with 100 W differential termination inside TXN31015D2 Optical Transceiver. The AC coupling is performed inside the TXN31015D2 Optical Transceiver and is therefore not required on the host board.
- MOD-DEF 1, 2: These pins are definition pins for the TXN31015D2 Optical Transceiver. They are pulled up with a 4.7 K - 10 K W resistor on the host board. Use a pull-up voltage between 2.0 V and V_{cc}T, R+0.3 V.
 - MOD-DEF 1 is the clock line of a 2-wire serial interface for serial ID.
 - MOD-DEF 2 is the data line of a 2-wire serial interface for serial ID.
- TX FAULT is a TTL output and has an internal 10k pull-up resistor to VccT.
 - Low: Indicates normal operation. In the low state, the output is pulled to < 0.8 V.
 - High: Indicates a laser fault.

Figure 1 shows the TXN31015D2 Optical Transceiver electrical interface pin numbers.



Figure 1. Pin Layout

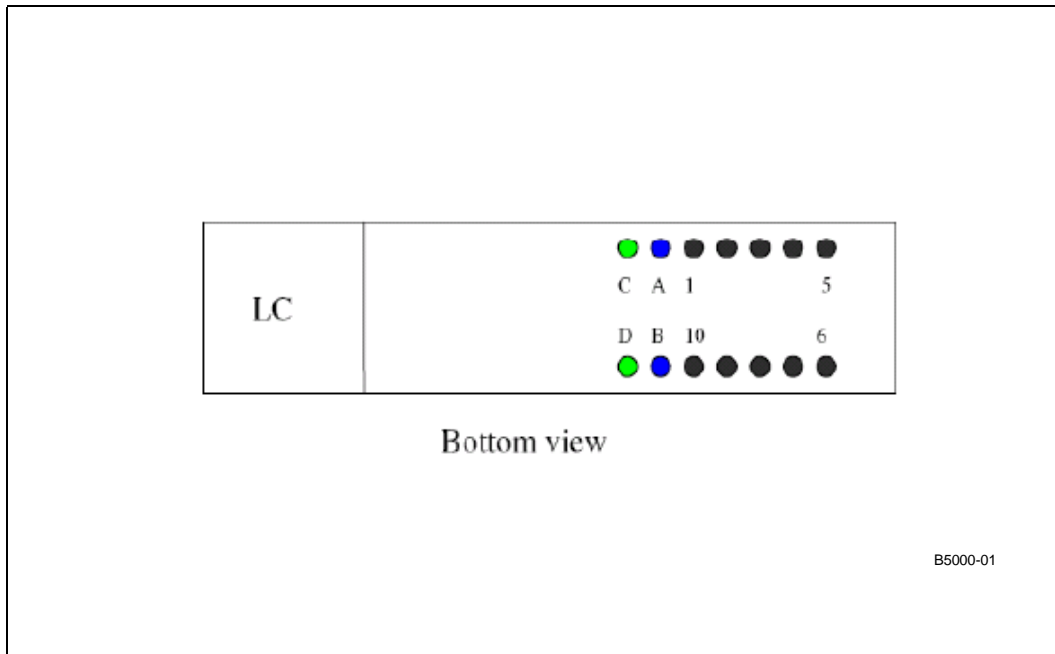



4.0 Termination

4.1 Types of I/O Interfaces

The TXN31015D2 Optical Transceiver has the following types of I/O interfaces.

- CML interface
- TTL interface

High-speed I/Os use the CML interface, while control signals use the TTL interface. Proper termination of I/Os is required for good signal integrity. If I/Os (particularly the CML I/Os) are not terminated properly, then jitter increases significantly due to reflection from impedance mismatches.

4.2 CML Termination

Figure 2 shows a circuit diagram for the CML termination for the TXN31015D2 Optical Transceiver receiver output. The TXN31015D2 Optical Transceiver has built in AC-coupling capacitors, which help prevent a direct current path from the TXN31015D2 Optical Transceiver power supply to the SerDes input. (A direct current path could damage the ESD diodes on the SerDes.)

- **Internal termination.** For the TXN31015D2 Optical Transceiver receiver output, the SerDes interface provides an internal termination resistor.
- **External termination.** For the proper external termination of the SerDes interface, refer to the SerDes specification.

Figure 2. Circuit Diagram for CML Termination on Receiver Output

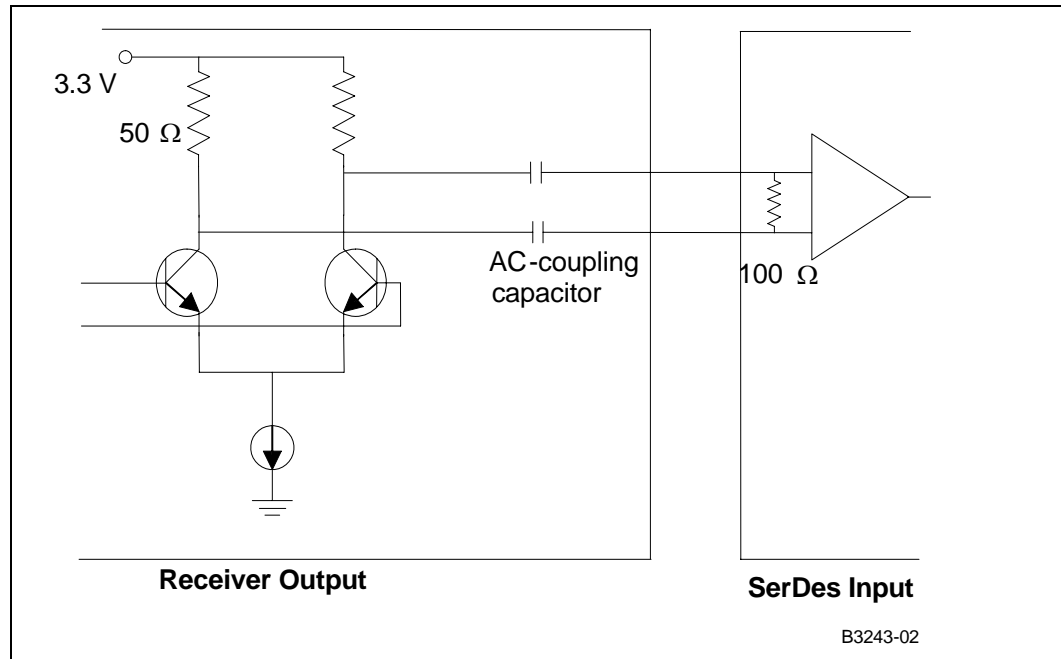
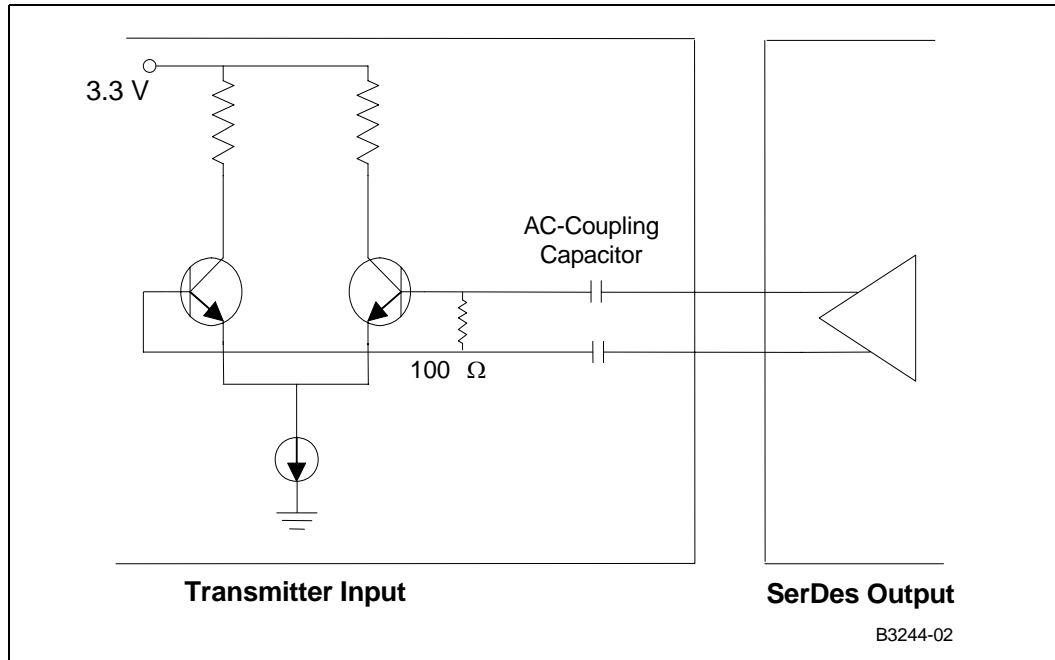

Figure 3 shows a circuit diagram for the CML termination for the TXN31015D2 Optical Transceiver transmitter input.

Internal termination. The TXN31015D2 Optical Transceiver transmitter input has an internal $100\ \Omega$ termination between two inputs. AC-coupling capacitors are also built into the TXN31015D2 Optical Transceiver.

Figure 3. Circuit Diagram for CML Termination on Transmitter Input





5.0 SFF Timing Parameters

Table 11 lists the timing parameters for SFF management.

Table 11. Timing Parameters for SFF Management

Parameter	Symbol	Min	Max	Unit	Conditions
TX_DISABLE assert time	t_off	–	10	µs	Time from rising edge of TX_DISABLE to when the optical output falls below 10% of nominal
TX_DISABLE negate time	t_on	–	1	ms	Time from falling edge of TX_DISABLE to when the modulated optical output rises above 90% of nominal
Time to initialize includes reset of TX_FAULT	t_init	–	300	ms	Time from power on or negation of TX_FAULT using TX_DISABLE
TX_FAULT Assert Time	t_fault	–	100	µs	Time from fault to TX_FAULT ON
TX Disable to reset	t_reset	10		µs	Time TX Disable must be held high to reset TX_FAULT
RX_Signal Detect Assert time	t_sd_on	–	100	µs	Time from non-Signal Detect state to RX_Signal Detect Assert
RX_Signal Detect De-assert time	t_sd_off	–	100	µs	Time from Signal Detect state to RX_non-Signal Detect De-assert
Serial ID Clock Rate	f_serial_clock	–	100	kHz	–



6.0 Digital Diagnostic Monitoring Interface

This section includes the following topics:

- [Section 6.1, “Overview of Digital Diagnostic Monitoring Interface” on page 18](#)
- [Section 6.2, “General Memory Map Descriptions” on page 19](#)
- [Section 6.3, “Alarm and Warning Fields for 2-Wire Interface Address A2h” on page 20](#)
- [Section 6.4, “A/D Fields for 2-Wire Interface Address A2h” on page 22](#)

6.1 Overview of Digital Diagnostic Monitoring Interface

The TXN31015D2 Optical Transceiver supports the 2-wire serial communication protocol. The TXN31015D2 Optical Transceiver has a digital diagnostic monitoring interface that is an extension of the serial ID interface defined in the Gigabit Interface Converter (GBIC) specification and the SFF Transceiver MultiSource Agreement (MSA) referenced in [Section 1.0, “Introduction” on page 7](#).

- **Standard SFF serial ID interface.** The standard SFF serial ID interface (the memory map for which is in [Table 12, “Memory Map – 2-Wire Address Range Descriptions” on page 19](#)) provides access to identification information using the 8-bit address 1010000X (A0h). The serial identification information describes information such as the following for the TXN31015D2 Optical Transceiver: capabilities, standard interfaces, and manufacturer information.
- **Digital diagnostic monitoring interface.** The digital diagnostic monitor interface (the memory map for which is in [Table 12, “Memory Map – 2-Wire Address Range Descriptions” on page 19](#)) is an extension of the standard serial ID interface. This interface, which uses the 8-bit address 1010001X (A2h) reserved for optical transceivers, allows real-time access to device-operating parameters while leaving unchanged the original serial ID memory map A0h. The digital diagnostic monitoring interface is backward compatible with both the GBIC specification and the SFF MSA.

Note: For details on the 2-wire addresses A0h and A2h, refer to the SFF-8472 document referenced in [Section 1.0, “Introduction” on page 7](#).



6.2 General Memory Map Descriptions

Table 12 lists descriptions of address ranges for the serial ID memory map.

- The 2-wire address A0h contains serial ID information defined by the SFF MSA.
- The 2-wire address A2h contains data related to the digital diagnostics, defined by the SFF-8472 document referenced in [Section 1.0, "Introduction" on page 7](#).

Table 12. Memory Map – 2-Wire Address Range Descriptions

2-Wire Address 1010000X (A0h)		2-Wire Address 1010001X (A2h)	
Address Range	Address Range Description (Standard Serial ID Information)	Address Range	Address Range Description (Digital Diagnostics Information)
0-95	Serial ID Defined SFF MSA (96 bytes)	0-39	Alarm and Warning (40 bytes) For details, see Table 13, "Alarm and Warning Fields – 2-Wire Address A2h, Address 0-95" .
		40-95	Vendor Specific / Calibration Constants (56 bytes) For details, see Table 13, "Alarm and Warning Fields – 2-Wire Address A2h, Address 0-95" .
96-127	Vendor Specific (32 bytes)	96-119	Real Time Digital Diagnostics Interface (24 bytes) For details, see the following: <ul style="list-style-type: none"> • Table 14, "A/D Fields – 2-Wire Address A2h, Addresses 96-109" on page 22 • Table 15, "A/D Status/Control Bits – 2-Wire Address A2h, Address 110" on page 22
		120-127	Vendor Specific (8 bytes)
128-255	Reserved in SFF MSA (128 bytes)	128-247	User Writable EEPROM (120 bytes)
		248-255	Vendor Specific (8 bytes)



6.3 Alarm and Warning Fields for 2-Wire Interface Address A2h

Table 13 is a more detailed memory map of the 2-wire interface address A2h for the Alarm and Warning fields, address range 0 to 95.

Table 13. Alarm and Warning Fields – 2-Wire Address A2h, Address 0-95 (Sheet 1 of 2)

Data Address	Field Size (Bytes)	Field Name	Field Description
Base ID Fields			
0	1	Temperature High alarm	MSB at low address
1	1	LSB	MSB at low address
2	1	Temperature Low alarm	MSB at low address
3	1	LSB	MSB at low address
4	1	Temperature High Warning	MSB at low address
5	1	LSB	MSB at low address
6	1	Temperature Low Warning	MSB at low address
7	1	LSB	MSB at low address
8	1	Vcc High Alarm	MSB at low address
9	1	LSB	MSB at low address
10	1	Vcc Low Alarm	MSB at low address
11	1	LSB	MSB at low address
12	1	Vcc High Warning	MSB at low address
13	1	LSB	MSB at low address
14	1	Vcc Low Warning	MSB at low address
15	1	LSB	MSB at low address
16	1	Bias High Alarm	MSB at low address
17	1	LSB	MSB at low address
18	1	Bias Low Alarm	MSB at low address
19	1	LSB	MSB at low address
20	1	Tx Bias High Warning	MSB at low address
21	1	LSB	MSB at low address
22	1	Tx Bias Low Warning	MSB at low address
23	1	LSB	MSB at low address
24	1	Tx Power High Alarm	MSB at low address
25	1	LSB	MSB at low address
26	1	Tx Power Low Alarm	MSB at low address
27	1	LSB	MSB at low address
28	1	Tx Power High Warning	MSB at low address
29	1	LSB	MSB at low address
30	1	Tx Power Low Warning	MSB at low address
31	1	LSB	MSB at low address
32	1	Rx Power High Alarm	MSB at low address
33	1	LSB	MSB at low address



Table 13. Alarm and Warning Fields – 2-Wire Address A2h, Address 0-95 (Sheet 2 of 2)

Data Address	Field Size (Bytes)	Field Name	Field Description
34	1	Rx Power Low Alarm	MSB at low address
35	1	LSB	MSB at low address
36	1	Rx Power High Warning	MSB at low address
37	1	LSB	MSB at low address
38	1	Rx Power Low Warning	MSB at low address
39	1	LSB	MSB at low address
40-55	16	Vendor-Specific	–
56-95	40	Calibration Constants	–



6.4 A/D Fields for 2-Wire Interface Address A2h

Table 14 lists descriptions of the analog-to-digital (A/D) fields for the 2-wire interface address A2h, data addresses 96 to 109.

Table 14. A/D Fields – 2-Wire Address A2h, Addresses 96-109

Data Address	Field Size (Bytes)	Field Name	Field Description
96	1	Temperature MSB	Signed 2's complement integer °C (-40 to +125). Based on internal temperature measurement.
97	1	Temperature LSB	Fractional part of temperature (count/256)
98	1	Vcc MSB	Internally measured supply voltage in transceiver. Voltage reading is full 16-bit value × 100 µVolt. (Yields range of 0 to 6.55V)
99	1	Vcc LSB	
100	1	TX Bias MSB	Measured Laser Bias Current in mA. Bias current is full 16-bit value × 2 µA. (Full range of 0 to +131 mA)
101	1	TX Bias LSB	
102	1	TX power MSB	Measure TX output power in mW. TX power is full 16-bit value × 0.1 µW. (Full range of -40 to +8.2 dBm)
103	1	TX power LSB	
104	1	RX Power MSB	Measured RX input power in mW. RX power is full 16-bit value × 0.1 µW. (Full range of -40 to +8.2dBm)
105	1	RX Power LSB	
106-109	4	Reserved	–

Table 15 lists descriptions of the A/D status/control bits for the 2-wire interface address A2h, data address 110.

Table 15. A/D Status/Control Bits – 2-Wire Address A2h, Address 110

Data Address	Bit	Bit Name	Bit Description
110	2	Tx Fault	Digital State of Tx Fault Output
110	1	SD	Digital State of Signal Detect. This bit is set when non-Signal Detect, it is cleared in normal operation.
110	0	Data Ready Bar	Indicates transceiver has achieved power up and is ready.

7.0 Grounding Scheme

There are two types of grounding on the TXN31015D2 Optical Transceiver.

- **Chassis ground.** The LC “nose” and the TXN31015D2 Optical Transceiver housing chassis comprise the chassis ground, which is used to connect to the system chassis ground.
- **Signal ground.** On the TXN31015D2 Optical Transceiver, there are two separate signal grounds.

The Receiver Ground pin (pin 1) on the TXN31015D2 Optical Transceiver is connected to the internal TXN31015D2 Optical Transceiver RX signal ground. The Transmitter Ground pin (pin 7) on the TXN31015D2 Optical Transceiver is connected to the internal TXN31015D2 Optical Transceiver TX signal ground.



The chassis ground and the signal ground are separated to prevent ESD from the main chassis ground moving directly to the TXN31015D2 Optical Transceiver. For good EMI and ESD performance, Intel recommends connecting these two signal grounds as follows:

- Connect Pin 1 to the RX signal ground on the host board adaptor (HBA) printed circuit board.
- Connect Pin 7 to the TX signal ground on the HBA printed circuit board.

Figure 4 shows a grounding application diagram for the TXN31015D2 Optical Transceiver. Proper grounding is critical for good EMI and ESD performance.

Figure 4. Grounding Application Diagram for Intel® TXN31015D2 Optical Transceiver

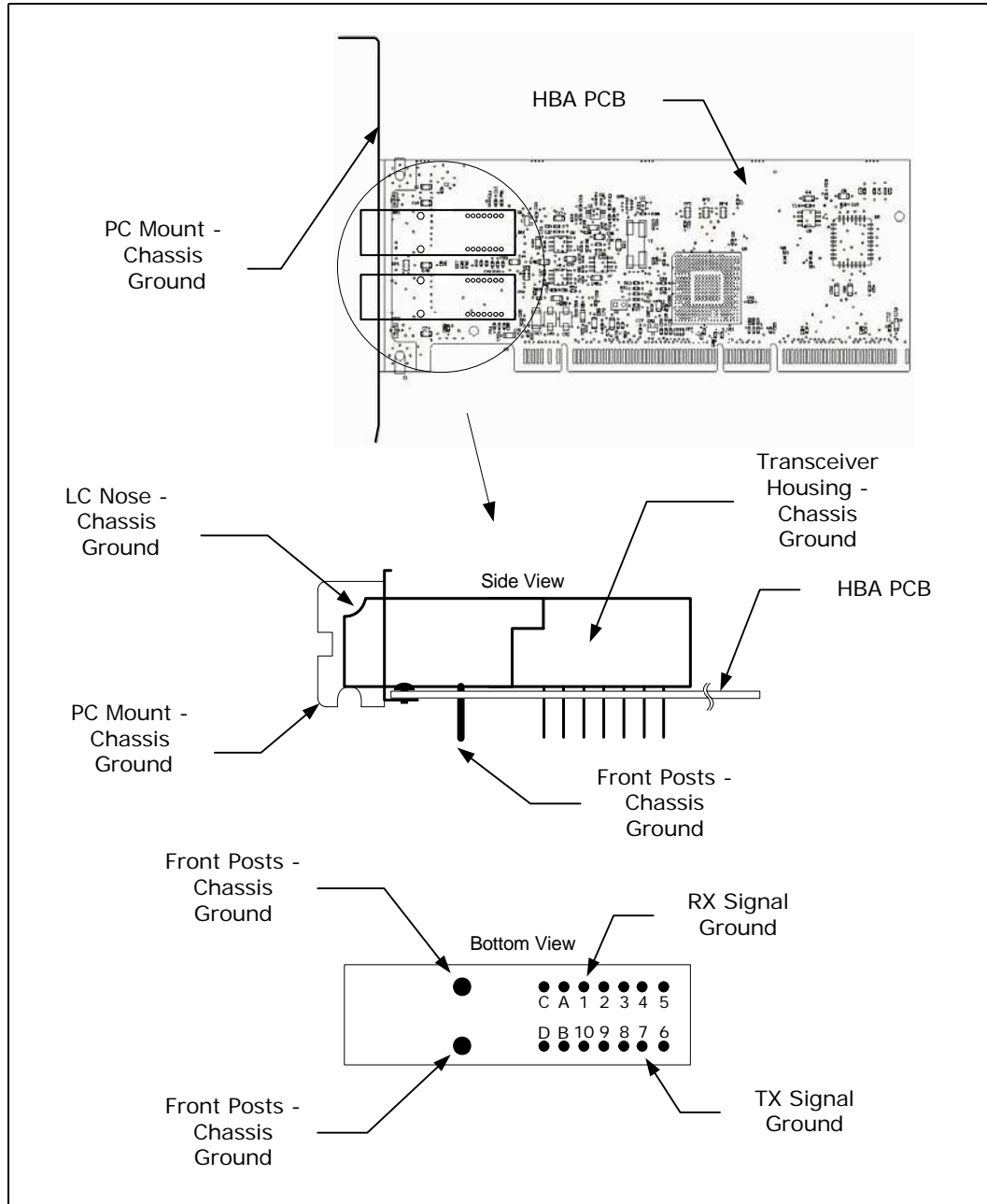



8.0 Mechanical Specification

Figure 5 shows the TXN31015D2 Optical Transceiver SFF mechanical specifications. The dimensions comply with the SFF Multisource Agreement (MSA).

Note: Aqueous wash is not applicable for this product.



Figure 5. SFF Mechanical Specifications

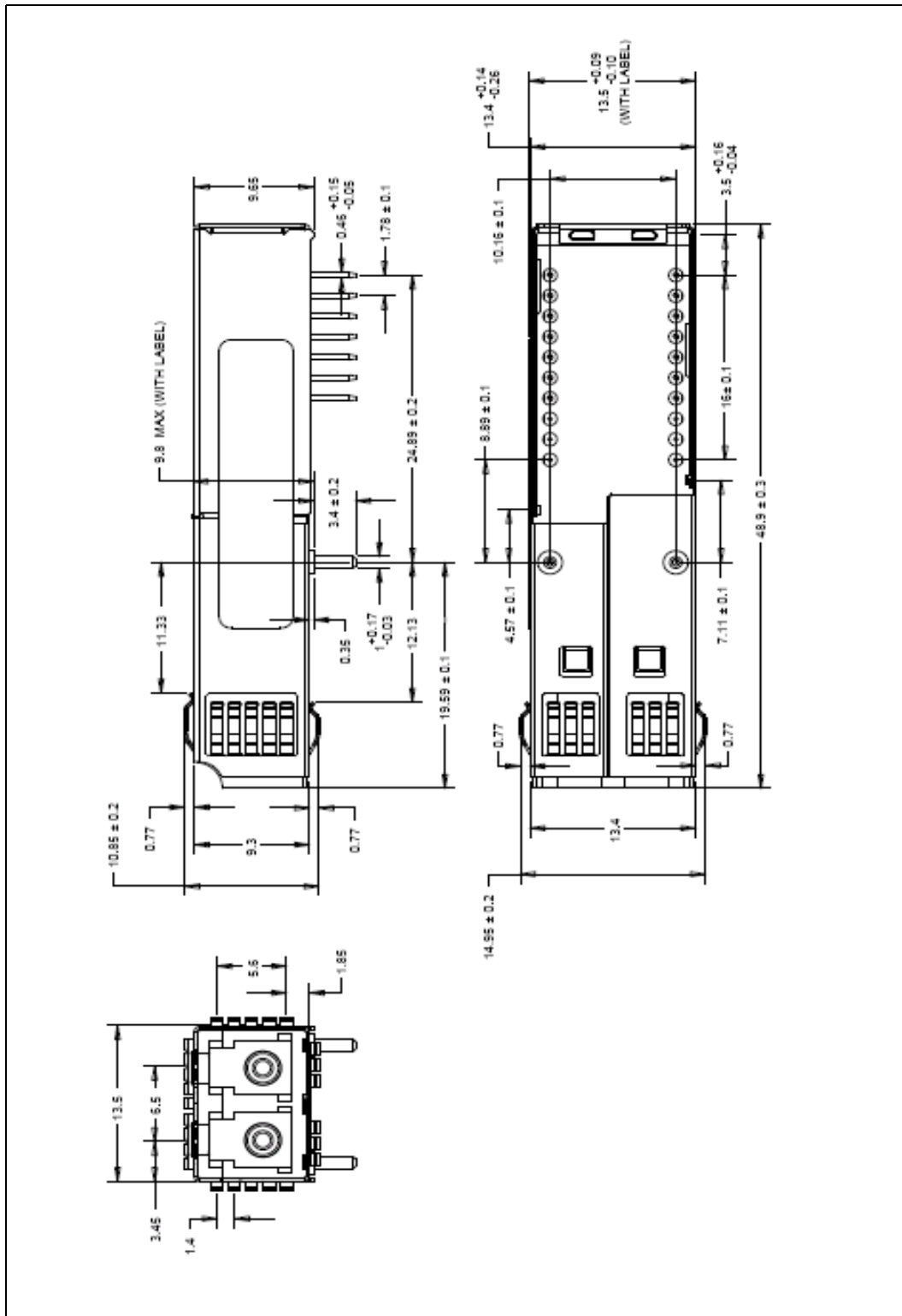



9.0 Regulatory Compliance

This section discusses the following topics:

- Section 9.1, “Electromagnetic Compatibility Compliance” on page 27
- Section 9.2, “Safety Compliance” on page 28
- Section 9.3, “Lead-Free Conformance” on page 29
- Section 9.4, “Compliance with Restriction of Hazardous Substances (RoHS)” on page 29
- Section 9.5, “Management Methods on Control of Pollution from Electronic Information Products (a.k.a. China RoHS)” on page 30
- Section 9.6, “Product Certification Markings and Compliance Statements” on page 31

9.1 Electromagnetic Compatibility Compliance

Table 16 lists emissions and immunity regulations with which the TXN31015D2 Optical Transceiver complies when tested in a representative chassis.

Table 16. Electromagnetic Compatibility Compliance

Requirement	Regulation	Performance Level
Electromagnetic interference (EMI)	<ul style="list-style-type: none"> • FCC rules, Part 15, subpart B • EN 55022 	Meets Class B limits with a minimum 6 dB margin
Electrostatic discharge (ESD)	JEDEC JESD22-A114-B Human Body Model	± 2 kV contact discharge to connector electrical pins with no degradation in performance or loss of function
	EN 61000-4-2	<ul style="list-style-type: none"> • ± 15 kV air discharge • ± 8 kV contact discharge to face plate Meets Level B test criteria (that is, no degradation of performance or loss of function occurs). Note: Actual ESD may vary, depending on system configuration.
Radio frequency electromagnetic field (Radiated immunity)	EN 61000-4-3, Level A test criteria	10 V/m from 80 MHz to 1 GHz with no degradation of performance or loss of function



9.2 Safety Compliance

Table 17 lists and describes the relevant safety regulations with which the TXN31015D2 Optical Transceiver complies.

Table 17. Safety Compliance

Requirement	Regulation	Title
Product Safety	UL 60950-1 CSA C22.2 No. 60950-1	Information Technology Equipment – Safety - Part 1: General Requirements (USA and Canada)
	EN 60950-1+A11	Information Technology Equipment – Safety - Part 1: General Requirements (European Union)
	IEC 60950-1	Information Technology Equipment – Safety - Part 1: General Requirements (International)
	GR-63-CORE Section 4.2, Clause 4.2.3.1	Compliant with the fire resistance requirements of Telcordia Technologies Generic Requirements GR-63-CORE document for discrete electronic components.
Laser Safety	21CFR1040.10	Title 21 Chapter I Subchapter J – Radiological Health Part 1040: Performance Standards for Light-Emitting Products
	EN 60825-1+A1 +A2	Safety of Laser Products - Part 1: Equipment Classification, Requirements and User's Guide
	IEC 60825-1+A1 +A2	Safety of Laser Products - Part 1: Equipment Classification, Requirements and User's Guide
	EN 60825-2	Safety of Laser Products - Part 2: Safety of Optical Fiber Communication Systems
	IEC 60825-2	Safety of Laser Products - Part 2: Safety of Optical Fiber Communication Systems

Caution: This device is a Class 1 laser product for use only under the recommended operating conditions and ratings specified in this document.





9.3 Lead-Free Conformance

The TXN31015D2 Optical Transceiver uses a lead-free assembly, although certain discrete components within the assembly may contain lead, being necessary for either component performance or reliability. The TXN31015D2 Optical Transceiver is referred to as a "Lead-free 2nd Level Interconnect." The enclosure, circuit board substrate, and the solder connections from the circuit board to the components (second-level connections) are all lead-free.

Table 18 lists various forms of the "Lead-Free 2nd Level Interconnect" marking for the TXN31015D2 Optical Transceiver and accompanying collateral.

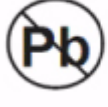
Table 18. Lead-Free 2nd-Level Interconnect Markings

Description	Marking
<p>Lead-Free 2nd Level Interconnect: The Lead-Free 2nd Level Interconnect symbol is used to identify electrical and electronic assemblies and components in which the lead (Pb) concentration level in the circuit board substrate and the solder connections from the circuit board to the components (second-level interconnect) are not greater than 0.1% by weight (1000 ppm).</p> <p>Note: Any of the three symbols shown may be used, as space permits.</p>	<div style="text-align: center;">  2nd Level Interconnect </div> <p style="text-align: center;">or</p> <div style="text-align: center;">  2nd lvl Intct </div> <p style="text-align: center;">or</p> <div style="text-align: center;">  2LI </div>

9.4 Compliance with Restriction of Hazardous Substances (RoHS)

This product complies with the European Union directive for Restriction of Hazardous Substances (RoHS) – *Restriction on the Use of Certain Hazardous Substances in Electrical and Electronic Equipment*, Directive 2002/95/EC plus amendments.

However, certain discrete components do contain lead (an RoHS-restricted substance) in amounts that exceed threshold concentration levels. This product uses the following applicable RoHS technology exemptions:

- Lead in optical and filter glass
- Lead in glass of electronic components

Note: RoHS implementation details are subject to change.

This product is RoHS 6 compliant, defined as complying with the restriction for all six listed substances by meeting strict threshold levels for those substances or through the use of the applicable exemptions listed above.



9.5 Management Methods on Control of Pollution from Electronic Information Products (a.k.a. China RoHS)

关于符合中国《电子信息产品污染控制管理办法》的声明

Table 19. Hazardous Substances Table

产品中有毒有害物质的名称及含量





部件名称 (Parts)	有毒有害物质或元素 (Hazardous Substance)					
	铅 (Pb)	汞 (Hg)	镉 (Cd)	六价铬 (Cr(VI))	多溴联苯 (PBB)	多溴二苯醚 (PBDE)
集成光电器件 Integrated optical circuit board assembly	×	○	○	○	○	○
金属盒件 Metal enclosure	○	○	○	○	○	○
<p>○：表示该有毒有害物质在该部件所有均质材料中的含量均在SJ/T 11363-2006标准规定的限量要求以下。</p> <p>○：Indicates that this hazardous substance contained in all homogeneous materials of this part is below the limit requirement in SJ/T 11363-2006.</p> <p>×：表示该有毒有害物质至少在该部件的某一均质材料中的含量超出SJ/T 11363-2006标准规定的限量要求。</p> <p>×：Indicates that this hazardous substance contained in at least one of the homogeneous materials of this part is above the limit requirement in SJ/T 11363-2006.</p> <p>对销售之日的所售产品, 本表显示我公司供应链的电子产品信息产品可能包含这些物质。注意：在所售产品中可能会也可能不会含有所有所列的部件。</p> <p>This table shows where these substances may be found in the supply chain of our electronic information products, as of the date of sale of the enclosed product. Note that some of the component types listed above may or may not be a part of the enclosed product.</p>						
<div style="display: flex; align-items: center;">  <p>除非另外特别的标注, 此标志为针对所涉及产品的环保使用期限标志. 此环保使用期限只适用于产品在产品手册中所规定的条件下工作。</p> <p>The Environment-Friendly Use Period (EFUP) for all enclosed products and their parts are per the symbol shown here, unless otherwise marked. The Environment-Friendly Use Period is valid only when the product is operated under the conditions defined in the product manual.</p> </div>						



9.6 Product Certification Markings and Compliance Statements

Table 20 lists the TXN31015D2 Optical Transceiver product certification markings and compliance statements.

Table 20. Product Certification Markings and Compliance Statements

Origin and Description	Markings and Compliance Statements
Markings	
<p>CE mark. The CE (Conformité Européene*) mark indicates compliance to the European Union Low Voltage directive (2006/95/EC, formerly 73/23/EEC).</p>	
<p>TÜV Rheinland type approval mark for components and subassemblies for the European Union. The Technischer Überwachungsverein* (TÜV – German for “Technical Inspection Association”) Rheinland type approval mark is for components and subassemblies for the European Union. Where space does not permit, the smaller alternate TÜV mark (see the next row in this table) may be used.</p>	
<p>TÜV Rheinland type approval mark for components and subassemblies for the European Union – <i>Alternate</i>. This alternate mark may be used where space constraints exist that do not permit use of the TÜV Rheinland mark in the previous row of this table.</p>	<p>Alternate TÜV mark:</p> 
<p>UL Recognized Component mark for the USA and Canada.</p>	
<p>China Environmental Friendly Use Period (EFUP) mark, where 30 in the marking denotes 30 years.</p>	
Compliance Statements	
<p>USA Food and Drug Administration (FDA), Center for Devices and Radiological Health compliance statement.</p>	<p>Complies with 21CFR 1040.10 except for deviations pursuant to Laser Notice No. 50, dated July 26, 2001.</p>
<p>USA FDA, Center for Devices and Radiological Health compliance statement – <i>Alternate</i>. Use the alternate statement listed, as needed.</p>	<p>Alternate FDA compliance statement: Complies with FDA performance standards for laser products except for deviations pursuant to Laser Notice No. 50, dated July 26, 2001.</p>



10.0 Ordering Information

Table 21 lists ordering information for the TXN31015D2 Optical Transceiver.

Table 21. Ordering Information

Product Number	MM Number	Description
TXN31015D200xxx ¹	874474	Quad-rate 4/2/1 Gbps Fibre Channel and Gigabit Ethernet SFF module with digital diagnostics feature compliant with RoHS 6
1. The last 3 characters of the part number ("xxx") are used to designate customer-specific customization. The Intel standard part has "000" as the last three characters.		



11.0 Acronyms

Table 22. Acronyms

Acronym	Meaning
A/D	Analog-to-Digital
BER	Bit Error Rate
CFR	Code of Federal Relations
CML	Current Mode Logic
EMI	Electro-Magnetic Interference
ESD	Electro-Static Discharge
EU	European Union
FC-PI	Fibre Channel – Physical Interfaces
FCC	Federal Communications Commission
FDA	Food and Drug Administration
GBIC	GigaBit Interface Converter
IEC	International Electrotechnical Commission
IEEE	Institute of Electrical and Electronics Engineers
LOS	Loss of Signal
MMF	Multimode Fiber
MSA	Multisource Agreement
NRZ	Non-Return to Zero
Pb	Lead
PCB	Printed Circuit Board
PRBS	Pseudo Random Bit Sequence
RFI	Radio Frequency Immunity
SFF	Small-Form Factor
SCSI	Small Computer System Interface
SONET	Synchronous Optical Network
TOSA	Transmitter Optical Sub-Assembly
TTL	Transistor-Transistor Logic
TUV	Technischer Überwachungsverein
UL	Underwriter Laboratories*
VCSEL	Vertical Cavity Surface Emitting Laser



