

**SINGLE GENERAL PURPOSE LOW VOLTAGE COMPARATOR****AZV331****General Description**

The AZV331 is a low voltage 2.5V to 5.5V, single comparator, which has a very low supply current of 60 $\mu$ A, making the part an excellent choice for portable electronic systems. The device is pin-for-pin compatible replacement of the LMV331.

The AZV331 is built with BiCMOS process with bipolar input and output stages for improved noise performance. It is a cost-effective solution for portable consumer products where space, low voltage, low power and price are the primary specification in circuit design.

The AZV331 is available in space saving SC-70-5 and SOT-23-5 packages, the SC-70-5 is approximately half the size of the SOT-23-5.

**Features**

- Guaranteed 2.5V to 5.5V Performance.
- Industrial Temperature Range: -40°C to 85°C
- Low Supply Current: 60 $\mu$ A Typical
- Input Common Mode Voltage Range Includes Ground
- Low Output Saturation Voltage 200 mV Typical
- Open Collector Output for Maxima Flexibility
- Space Saving SC-70-5 and SOT-23-5 Packages

**Applications**

- Notebook and PDA
- Low Power, Low Voltage Applications
- General Purpose Portable Devices
- Mobile Communication
- Battery-Powered Systems

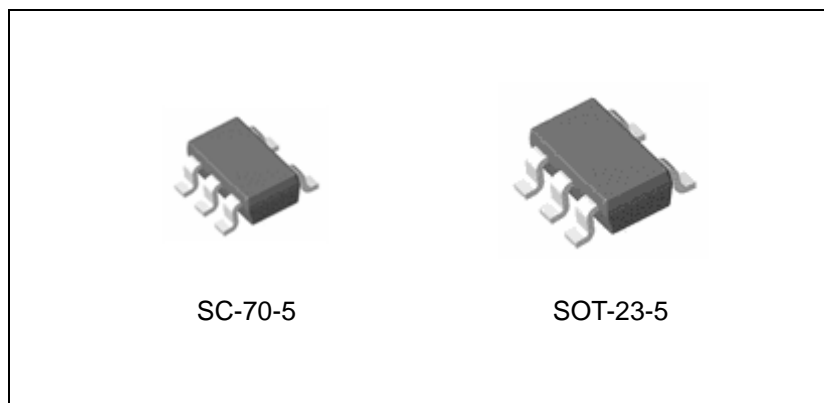

Figure 1. Package Types of AZV331

**SINGLE GENERAL PURPOSE LOW VOLTAGE COMPARATOR      AZV331**

**Pin Configuration**

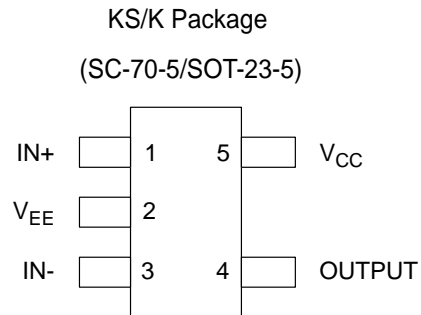

Figure 2. Pin Configuration of AZV331 (Top View)

**Functional Block Diagram**

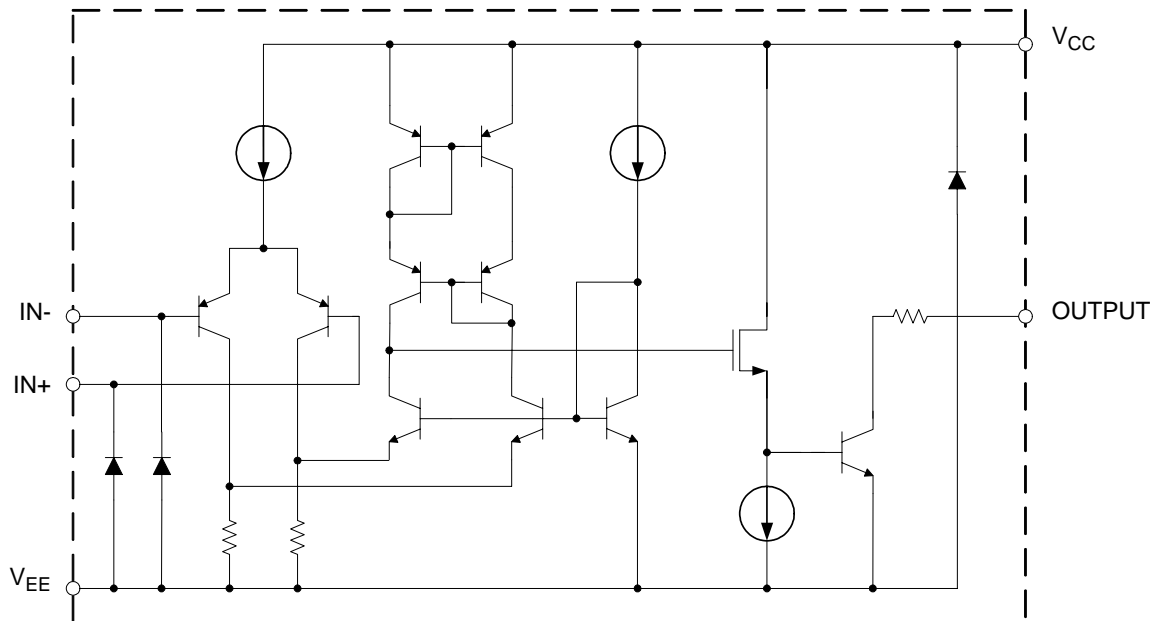
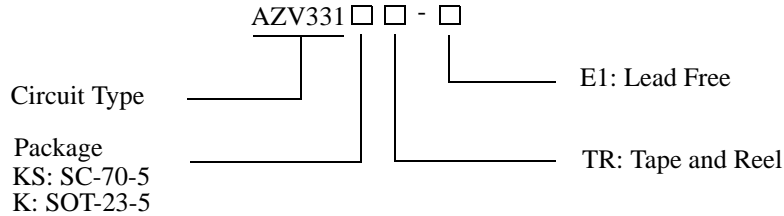

Figure 3. Functional Block Diagram of AZV331



**SINGLE GENERAL PURPOSE LOW VOLTAGE COMPARATOR AZV331**

**Ordering Information**



Package	Temperature Range	Part Number	Marking ID	Packing Type
		Lead Free	Lead Free	
SC-70-5	-40 to 85°C	AZV331KSTR-E1	22	Tape & Reel
SOT-23-5	-40 to 85°C	AZV331KTR-E1	E6S	Tape & Reel

BCD Semiconductor's Pb-free products, as designated with "E1" suffix in the part number, are RoHS compliant.

**Absolute Maximum Ratings (Note 1)**

Parameter	Symbol	Value	Unit
Power Supply Voltage	V <sub>CC</sub>	6	V
Operation Junction Temperature	T <sub>J</sub>	150	°C
Storage Temperature Range	T <sub>STG</sub>	-65 to 150	°C
Lead Temperature (Soldering, 10 Seconds)	T <sub>LEAD</sub>	260	°C
ESD (Machine Model)		300	V
ESD (Human Body Model)		4000	V

Note 1: Stresses greater than those listed under "Absolute Maximum Ratings" may cause permanent damage to the device. These are stress ratings only, and functional operation of the device at these or any other conditions beyond those indicated under "Recommended Operating Conditions" is not implied. Exposure to "Absolute Maximum Ratings" for extended periods may affect device reliability.

**Recommended Operating Conditions**

Parameter	Symbol	Min	Max	Unit
Supply Voltage	V <sub>CC</sub>	2.5	5.5	V
Ambient Operating Temperature Range	T <sub>A</sub>	-40	85	°C

**SINGLE GENERAL PURPOSE LOW VOLTAGE COMPARATOR****AZV331****2.7V DC Electrical Characteristics**

Limits in standard typeface are guaranteed for  $T_A=25^\circ\text{C}$ ,  $V_{CC}=2.7\text{V}$ ,  $V_{EE}=0\text{V}$ ,  $R_L=5.1\text{k}\Omega$  connected to  $V_{CC}$  and  $V_{CM}=0$ , **bold** typeface applies over full temperature ranges, unless otherwise specified.

Parameter	Symbol	Conditions	Min	Typ	Max	Unit
Input Offset Voltage	$V_{OS}$			1.7	7	mV
					<b>9</b>	
Input Offset Voltage Average Drift	$TCV_{OS}$			5		$\mu\text{V}/^\circ\text{C}$
Input Bias Current	$I_B$	$I_{IN+}$ or $I_{IN-}$ with output in linear range, $V_{CM}=0\text{V}$		10	250	nA
					<b>400</b>	
Input Offset Current	$I_{IO}$	$I_{IN+} - I_{IN-}$ , $V_{CM}=0\text{V}$		5	50	nA
					<b>150</b>	
Saturation Voltage	$V_{SAT}$	$I_{SINK} \leq 1\text{mA}$		200		mV
					<b>500</b>	
Output Sink Current	$I_{SINK}$	$V_O \leq 1.5\text{V}$	5	23		mA
Input Common-Mode Voltage Range	$V_{CM}$		-0.1		2	V
Supply Current	$I_{CC}$			40	100	$\mu\text{A}$
					<b>150</b>	
Output Leakage Current	$I_{LEAKAGE}$			0.003		$\mu\text{A}$

**2.7V AC Electrical Characteristics**

All limits are guaranteed for  $T_A=25^\circ\text{C}$ ,  $V_{CC}=2.7\text{V}$ ,  $V_{EE}=0\text{V}$ ,  $R_L=5.1\text{k}\Omega$  connected to  $V_{CC}$  and  $V_{CM}=0$ , unless otherwise specified.

Parameter	Symbol	Conditions	Min	Typ	Max	Unit
Propagation Delay (High to Low)	$T_{PHL}$	Input Overdrive=10mV		1000		ns
		Input Overdrive=100mV		350		
Propagation Delay (Low to High)	$T_{PLH}$	Input Overdrive=10mV		500		ns
		Input Overdrive=100mV		400		

**SINGLE GENERAL PURPOSE LOW VOLTAGE COMPARATOR****AZV331****5V DC Electrical Characteristics**

Limits in standard typeface are guaranteed for  $T_A=25^{\circ}\text{C}$ ,  $V_{CC}=5\text{V}$ ,  $V_{EE}=0\text{V}$ ,  $R_L=5.1\text{k}\Omega$  connected to  $V_{CC}$  and  $V_{CM}=0$ , **bold** typeface applies over full temperature ranges, unless otherwise specified.

Parameter	Symbol	Conditions	Min	Typ	Max	Unit
Input Offset Voltage	$V_{OS}$			1.7	7	mV
					<b>9</b>	
Input Offset Voltage Average Drift	$TCV_{OS}$			5		$\mu\text{V}/^{\circ}\text{C}$
Input Bias Current	$I_B$	$I_{IN+}$ or $I_{IN-}$ with output in linear range, $V_{CM}=0\text{V}$		25	250	nA
					<b>400</b>	
Input Offset Current	$I_{IO}$	$I_{IN+} - I_{IN-}$ , $V_{CM}=0\text{V}$		2	50	nA
					<b>150</b>	
Saturation Voltage	$V_{SAT}$	$I_{SINK} \leq 4\text{mA}$		200	400	mV
					<b>500</b>	
Output Sink Current	$I_{SINK}$	$V_O \leq 1.5\text{V}$	10	84		mA
Input Common-Mode Voltage Range	$V_{CM}$		-0.1		4.2	V
Voltage Gain	$A_V$		20	50		V/mV
Supply Current	$I_{CC}$			60	120	$\mu\text{A}$
					<b>150</b>	
Output Leakage Current	$I_{LEAKAGE}$			0.003		$\mu\text{A}$

**5V AC Electrical Characteristics**

All limits are guaranteed for  $T_A=25^{\circ}\text{C}$ ,  $V_{CC}=5\text{V}$ ,  $V_{EE}=0\text{V}$ ,  $R_L=5.1\text{k}\Omega$  connected to  $V_{CC}$  and  $V_{CM}=0$ , unless otherwise specified.

Parameter	Symbol	Conditions	Min	Typ	Max	Unit
Propagation Delay (High to Low)	$T_{PHL}$	Input Overdrive=10mV		600		ns
		Input Overdrive=100mV		200		
Propagation Delay (Low to High)	$T_{PLH}$	Input Overdrive=10mV		450		ns
		Input Overdrive=100mV		300		



**SINGLE GENERAL PURPOSE LOW VOLTAGE COMPARATOR** **AZV331**

**Typical Performance Characteristics**

$T_A=25^{\circ}\text{C}$ , unless otherwise specified.

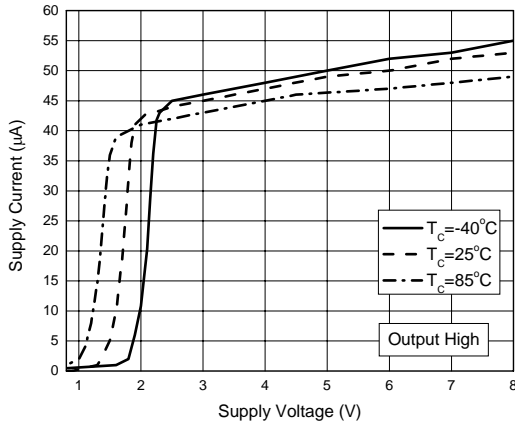

Figure 4. Supply Current vs. Supply Voltage

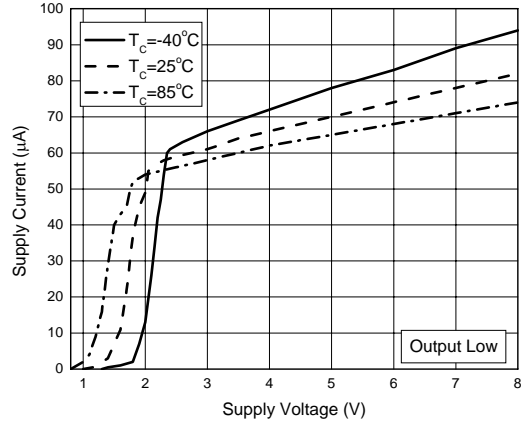

Figure 5. Supply Current vs. Supply Voltage

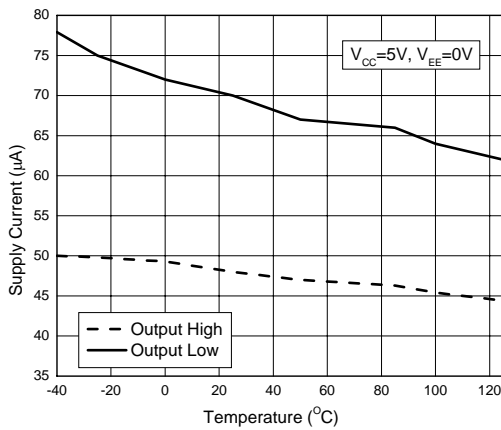

Figure 6. Supply Current vs. Temperature

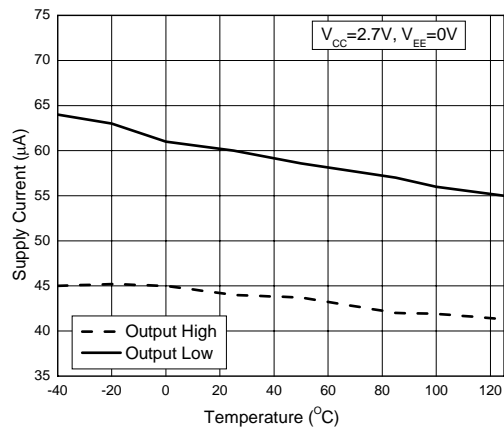

Figure 7. Supply Current vs. Temperature



**SINGLE GENERAL PURPOSE LOW VOLTAGE COMPARATOR AZV331**

**Typical Performance Characteristics (Continued)**

$T_A=25^\circ\text{C}$ , unless otherwise specified.

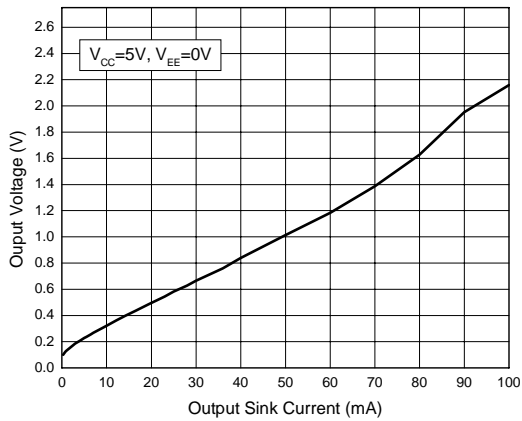

Figure 8. Output Voltage vs. Output Sink Current

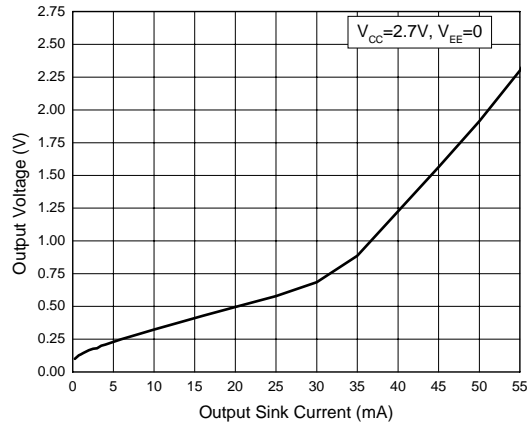

Figure 9. Output Voltage vs. Output Sink Current

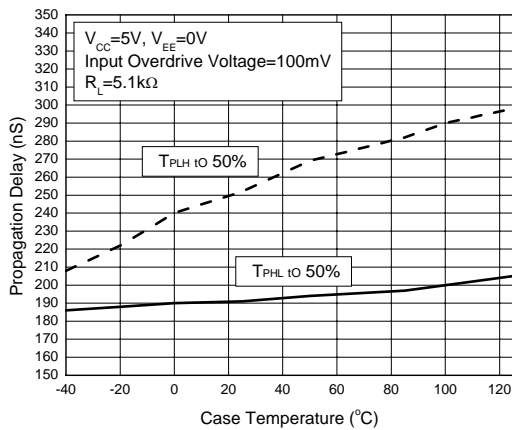

Figure 10. Propagation Delay vs. Temperature

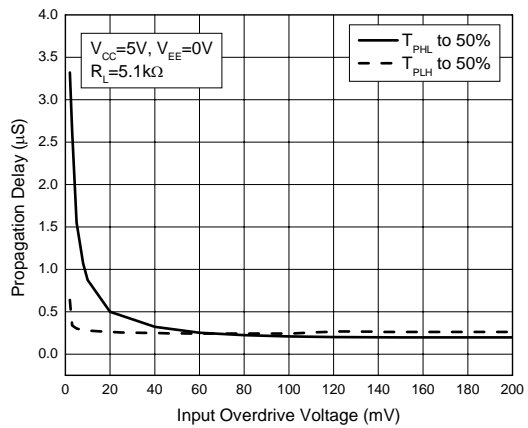

Figure 11. Propagation Delay vs. Input Overdrive Voltage



**SINGLE GENERAL PURPOSE LOW VOLTAGE COMPARATOR AZV331**

**Typical Performance Characteristics (Continued)**

$T_A=25^{\circ}\text{C}$ , unless otherwise specified.

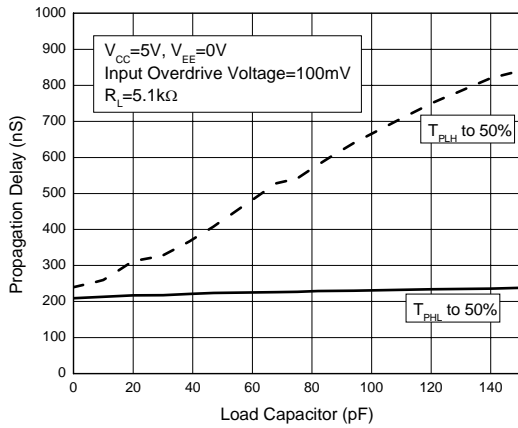

Figure 12. Propagation Delay vs. Load Capacitors

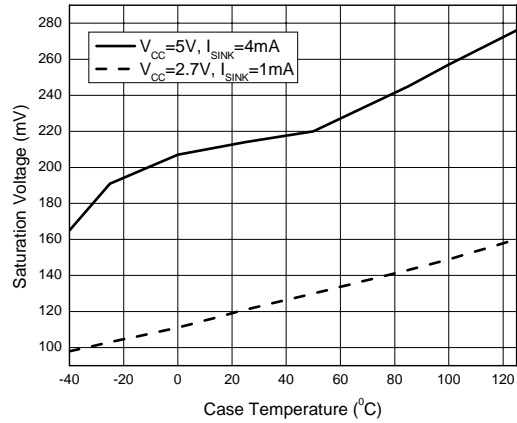

Figure 13. Saturation Voltage vs. Case Temperature

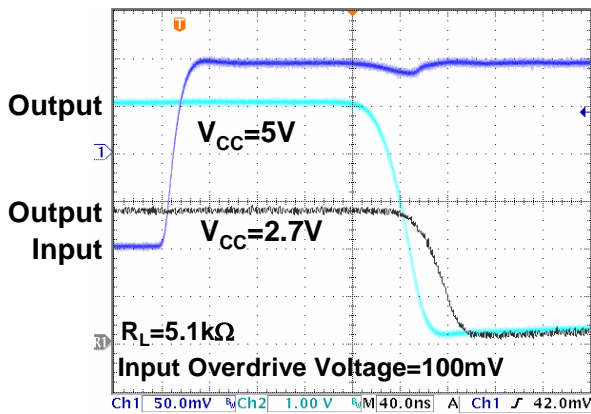

Figure 14. Response Time for Positive Transition

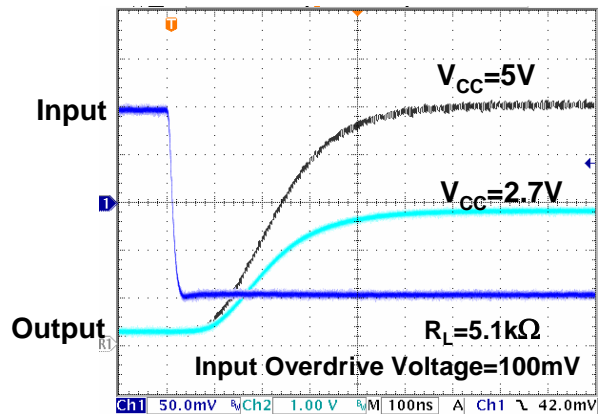

Figure 15. Response Time for Negative Transition



**SINGLE GENERAL PURPOSE LOW VOLTAGE COMPARATOR AZV331**

**Typical Performance Characteristics (Continued)**

$T_A=25^{\circ}\text{C}$ , unless otherwise specified.

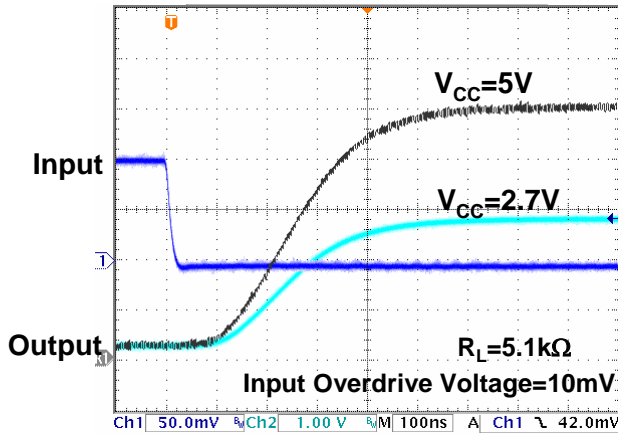

Figure 16. Response Time for Negative Transition

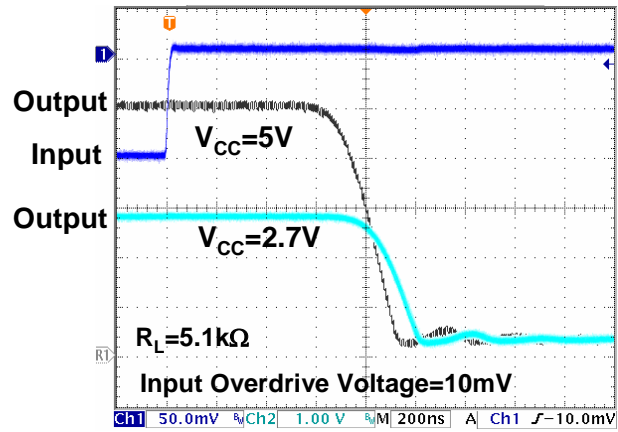

Figure 17. Response Time for Positive Transition

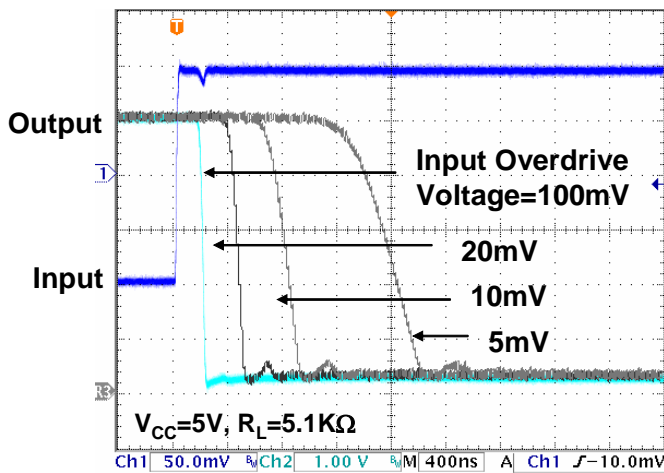

Figure 18. Response Time for Positive Transition

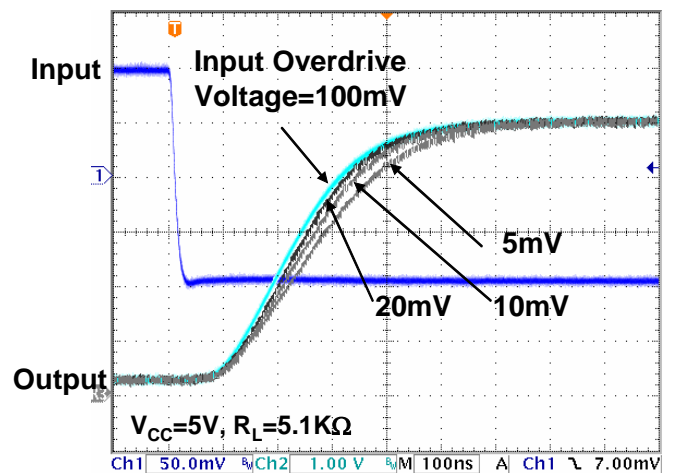

Figure 19. Response Time for Negative Transition



**SINGLE GENERAL PURPOSE LOW VOLTAGE COMPARATOR AZV331**

**Typical Performance Characteristics (Continued)**

$T_A=25^{\circ}\text{C}$ , unless otherwise specified.

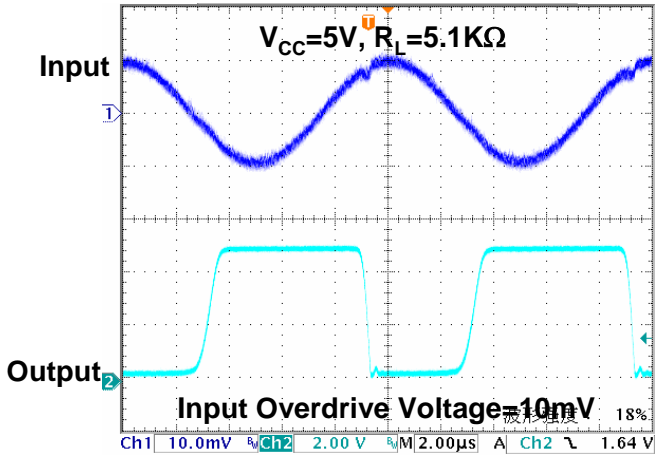

Figure 20. 100kHz Response

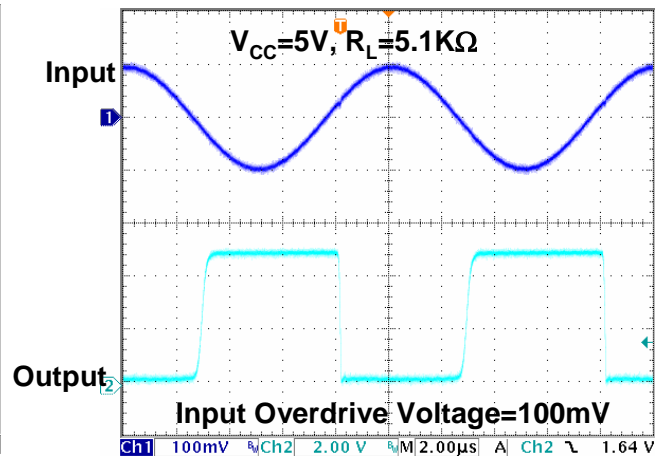

Figure 21. 100kHz Response

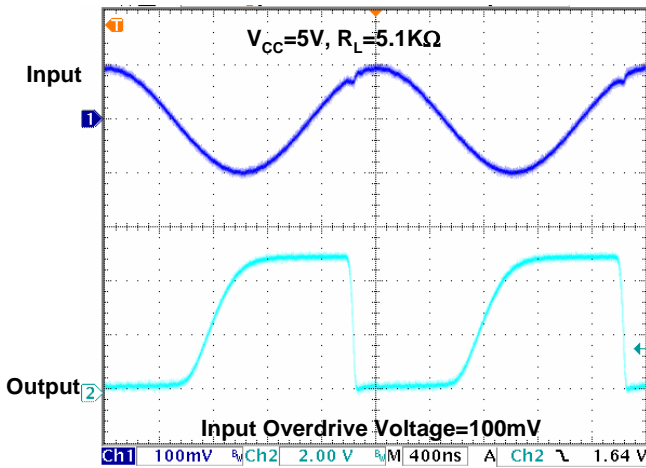

Figure 22. 500kHz Response

**SINGLE GENERAL PURPOSE LOW VOLTAGE COMPARATOR AZV331**

**Typical Application**

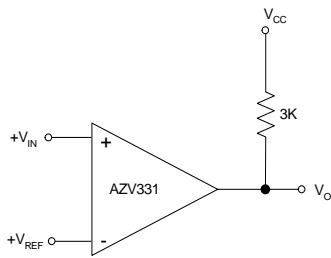

Figure 23. Basic Comparator

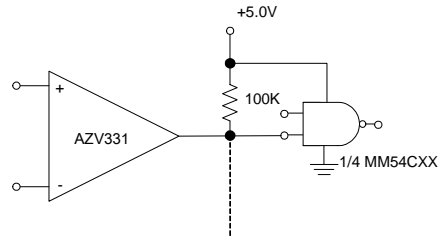

Figure 24. Driving CMOS/TTL

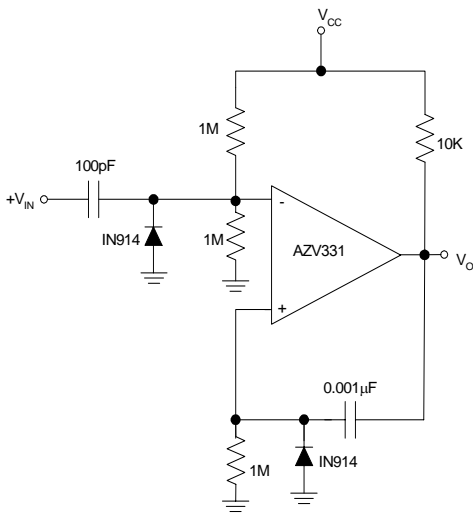

Figure 25. One Shot Multivibrator

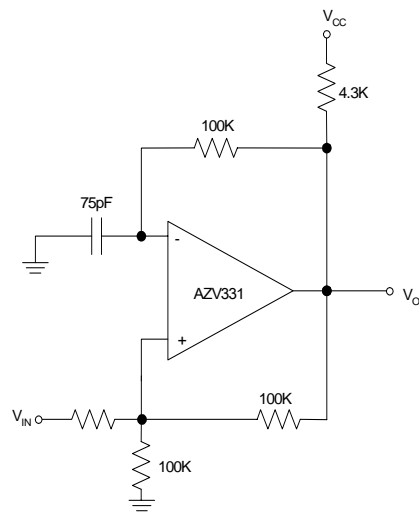

Figure 26. Squarewave Oscillator



**SINGLE GENERAL PURPOSE LOW VOLTAGE COMPARATOR**      **AZV331**

**Mechanical Dimensions**

**SC-70-5**

**Unit: mm(inch)**

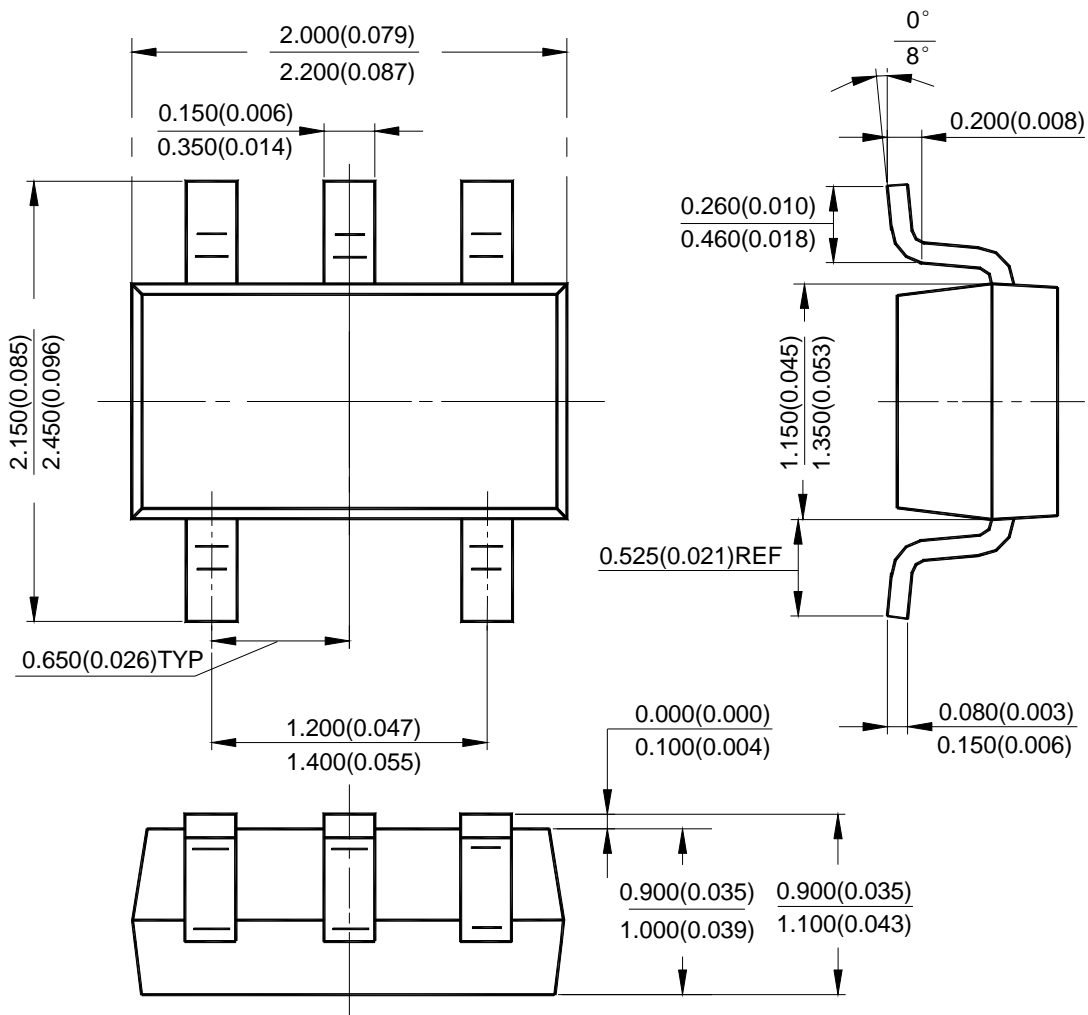



**SINGLE GENERAL PURPOSE LOW VOLTAGE COMPARATOR**      **AZV331**

**Mechanical Dimensions**

**SOT-23-5**

**Unit: mm(inch)**

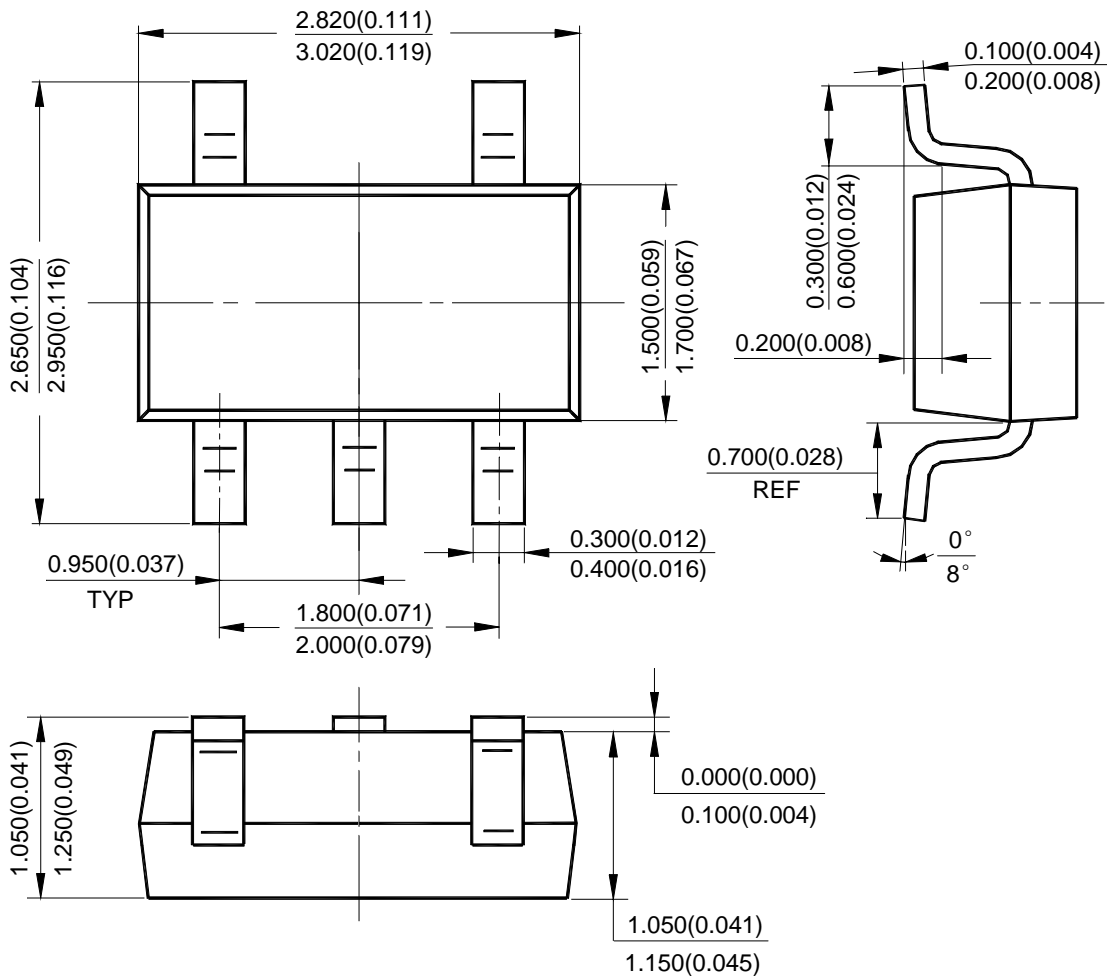



## **BCD Semiconductor Manufacturing Limited**

<http://www.bcdsemi.com>

### **IMPORTANT NOTICE**

BCD Semiconductor Manufacturing Limited reserves the right to make changes without further notice to any products or specifications herein. BCD Semiconductor Manufacturing Limited does not assume any responsibility for use of any its products for any particular purpose, nor does BCD Semiconductor Manufacturing Limited assume any liability arising out of the application or use of any its products or circuits. BCD Semiconductor Manufacturing Limited does not convey any license under its patent rights or other rights nor the rights of others.

---

#### **MAIN SITE**

##### **- Headquarters**

##### **BCD Semiconductor Manufacturing Limited**

No. 1600, Zi Xing Road, Shanghai Zizhu Science-based Industrial Park, 200241, China  
Tel: +86-21-24162266, Fax: +86-21-24162277

##### **- Wafer Fab**

##### **Shanghai SIM-BCD Semiconductor Manufacturing Co., Ltd.**

800 Yi Shan Road, Shanghai 200233, China  
Tel: +86-21-6485 1491, Fax: +86-21-5450 0008

#### **REGIONAL SALES OFFICE**

##### **Shenzhen Office**

**Shanghai SIM-BCD Semiconductor Manufacturing Co., Ltd., Shenzhen Office**  
Room E, 5F, Noble Center, No.1006, 3rd Fuzhong Road, Futian District, Shenzhen,  
518026, China  
Tel: +86-755-8826 7951  
Fax: +86-755-8826 7865

##### **Taiwan Office**

**BCD Semiconductor (Taiwan) Company Limited**  
4F, 298-1, Rui Guang Road, Nei-Hu District, Taipei,  
Taiwan  
Tel: +886-2-2656 2808  
Fax: +886-2-2656 2806

##### **USA Office**

**BCD Semiconductor Corp.**  
30920 Huntwood Ave. Hayward,  
CA 94544, USA  
Tel : +1-510-324-2988  
Fax: +1-510-324-2788