

GP1A05A2

OPIC Photointerrupter with Connector

■ Features

1. Uses 3-pin connector terminal
2. High sensing accuracy (Slit width : 0.5mm)
3. Wide gap between light emitter and detector (5mm)

■ Applications

1. Copiers, Printers
2. Facsimiles

■ Absolute Maximum Ratings (Ta=25°C)

Parameter	Symbol	Rating	Unit
Suppl voltage	V _{CC}	-0.5 to +8	V
*1 Output voltage	V _{OUT}	-0.5 to +28	V
*2 Low level output current	I _{OL}	50	mA
*3 Operating temperature	T _{opr}	-20 to +75	°C
*3 Storage temperature	T _{stg}	-40 to +85	°C

*1 Collector-emitter voltage of output transistor.

*2 Collector current of output transistor.

*3 The connector should be plugged in/out at normal temperature.

■ Outline Dimensions

(Unit : mm)

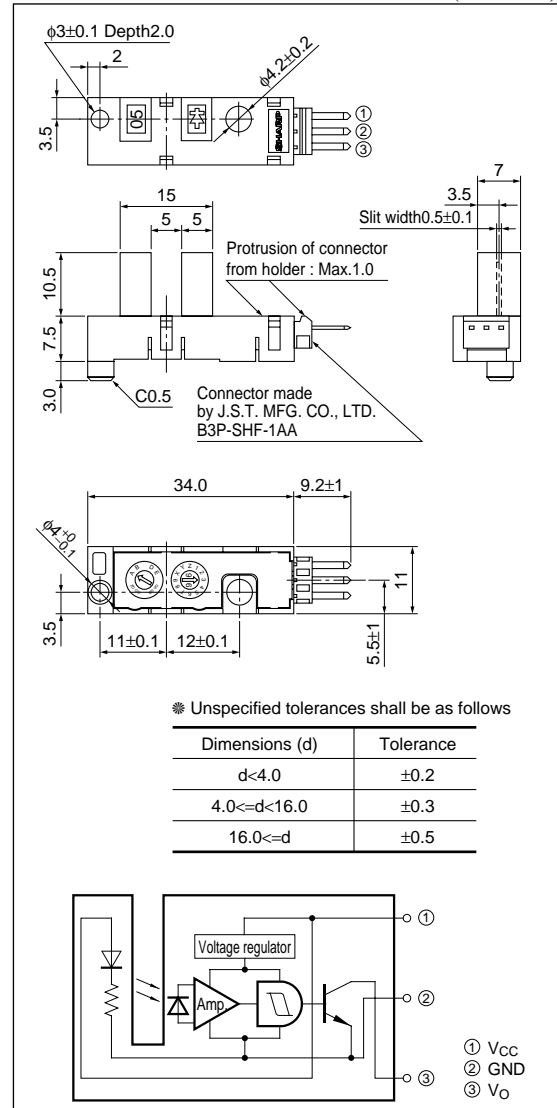

* "OPIC" (Optical IC) is a trademark of the SHARP Corporation.

An OPIC consists of a light-detecting element and signal-processing circuit integrated onto a single chip.

Electro-optical Characteristics

(Unless otherwise specified, $V_{CC}=5V$, $T_a=25^\circ C$)

Parameter	Symbol	Conditions	MIN.	TYP.	MAX.	Unit
Operating supply voltage	V_{CC}		4.5	-	5.5	V
Low level supply current	I_{CCL}	Light beam uninterrupted	-	-	30	mA
Low level output voltage	V_{OL}	Light beam uninterrupted, $I_{OL}=16mA$	-	-	0.35	V
High level supply current	I_{CCH}	Light beam interrupted	-	-	30	mA
High level output voltage	V_{OH}	Light beam interrupted, $R_L=47k\Omega$	$V_{CC}\times 0.9$	-	-	V
*4 Response frequency	f	No DC output is allowed, $R_L=47k\Omega$	-	-	3 000	Hz

*4 Refer to Fig.1

Fig.1 Response Frequency

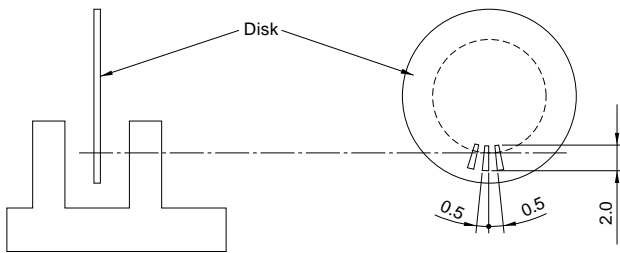

Response frequency is measured with the disk shown below being rotated. (Unit : mm)

Fig.2 Low Level Output Current vs. Ambient Temperature

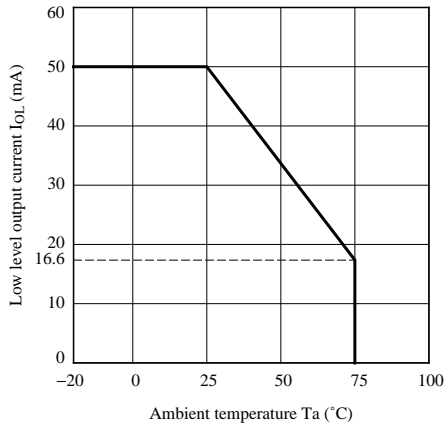

Fig.3 Low Level Output Voltage vs. Low Level Output Current

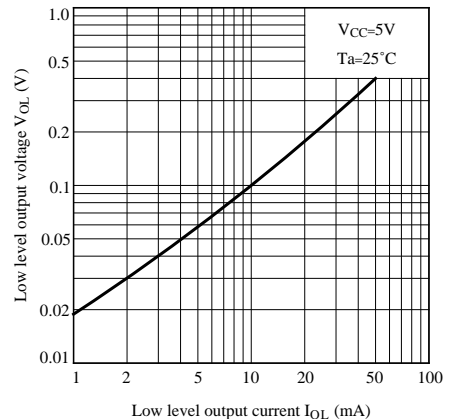

Fig.4 Low Level Output Voltage vs. Ambient Temperature

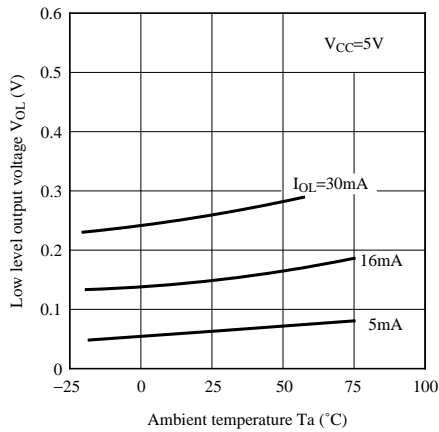

Fig.5 Supply Current vs. Supply Voltage

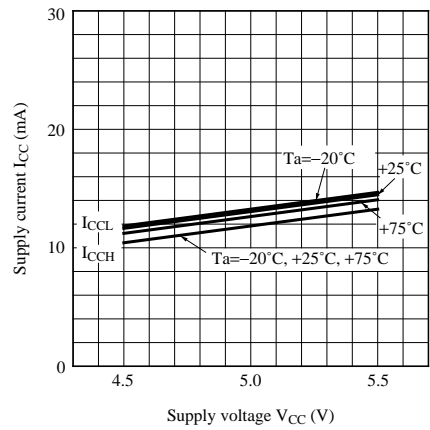

Fig.6 Detecting Position Characteristics (1)

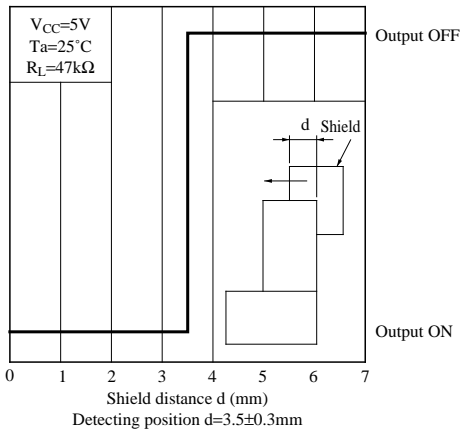
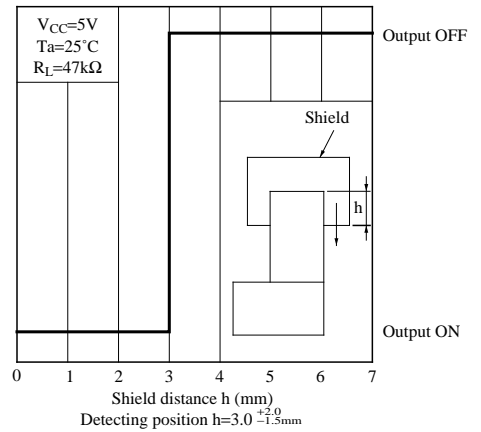

Fig.7 Detecting Position Characteristics (2)



■ Recommended Connectors on the Inserted Side

◆ JAPAN SOLDERLESS TERMINAL MFG. CO., LTD. made

(Natural color • bulk)

Housing Model No.	H3P-SHF-AA			S3P-SHF-1		
Special terminal Model. No.	AWG size	Material	Model No.	AWG size	Material	Model No.
	AWG 28 to 22	Brass	SHF-001T-0.8SS	AWG 27 to 22	Brass	SHF-001T-0.8P
		Copper phosphide	SHF-001T-0.8BS		Copper phosphide	–
	AWG 30 to 28	Brass	SHF-002T-0.8SS	AWG 30 to 28	Brass	SHF-002T-0.8P
		Copper phosphide	SHF-002T-0.8BS		Copper phosphide	–

■ Precautions for Use

1. It is recommended that a by-pass capacitor of more than 0.01 μ F be added between V_{CC} and GND near the device in order to stabilize power supply line.
2. Please don't carry out immersion cleaning or ultrasonic cleaning to avoid keeping solvent inside case of this device.
3. Remove dust or stains, using an air blower or a soft cloth moistened in cleaning solvent.
However, do not perform the above cleaning using a soft cloth with cleaning solvent in the marking portion.
In this case, use only the following type of cleaning solvent used for wiping off :
Ethyl alcohol, Methyl alcohol, Isopropyl alcohol,
When the cleaning solvents except for specified materials are used, please consult us.
4. As for other general cautions, refer to the chapter "Precautions for Use. "

NOTICE

- The circuit application examples in this publication are provided to explain representative applications of SHARP devices and are not intended to guarantee any circuit design or license any intellectual property rights. SHARP takes no responsibility for any problems related to any intellectual property right of a third party resulting from the use of SHARP's devices.
- Contact SHARP in order to obtain the latest device specification sheets before using any SHARP device. SHARP reserves the right to make changes in the specifications, characteristics, data, materials, structure, and other contents described herein at any time without notice in order to improve design or reliability. Manufacturing locations are also subject to change without notice.
- Observe the following points when using any devices in this publication. SHARP takes no responsibility for damage caused by improper use of the devices which does not meet the conditions and absolute maximum ratings to be used specified in the relevant specification sheet nor meet the following conditions:
 - (i) The devices in this publication are designed for use in general electronic equipment designs such as:
 - Personal computers
 - Office automation equipment
 - Telecommunication equipment [terminal]
 - Test and measurement equipment
 - Industrial control
 - Audio visual equipment
 - Consumer electronics
 - (ii) Measures such as fail-safe function and redundant design should be taken to ensure reliability and safety when SHARP devices are used for or in connection with equipment that requires higher reliability such as:
 - Transportation control and safety equipment (i.e., aircraft, trains, automobiles, etc.)
 - Traffic signals
 - Gas leakage sensor breakers
 - Alarm equipment
 - Various safety devices, etc.
 - (iii) SHARP devices shall not be used for or in connection with equipment that requires an extremely high level of reliability and safety such as:
 - Space applications
 - Telecommunication equipment [trunk lines]
 - Nuclear power control equipment
 - Medical and other life support equipment (e.g., scuba).
- Contact a SHARP representative in advance when intending to use SHARP devices for any "specific" applications other than those recommended by SHARP or when it is unclear which category mentioned above controls the intended use.
- If the SHARP devices listed in this publication fall within the scope of strategic products described in the Foreign Exchange and Foreign Trade Control Law of Japan, it is necessary to obtain approval to export such SHARP devices.
- This publication is the proprietary product of SHARP and is copyrighted, with all rights reserved. Under the copyright laws, no part of this publication may be reproduced or transmitted in any form or by any means, electronic or mechanical, for any purpose, in whole or in part, without the express written permission of SHARP. Express written permission is also required before any use of this publication may be made by a third party.
- Contact and consult with a SHARP representative if there are any questions about the contents of this publication.