



STC08IE150HV

Emitter switched bipolar transistor
 ESBT[®] 1500V - 8A - 0.08 Ω

Features

$V_{CS(ON)}$	I_C	$R_{CS(ON)}$
0.65 V	8 A	0.08 Ω

- High voltage / high current cascode configuration
- Low equivalent on resistance
- Very fast-switch, up to 150 kHz
- Squared RBSOA, up to 1500 V
- Very low C_{ISS} driven by $R_G = 4.7 \Omega$
- Very low turn-off cross over time

Application

- Aux SMPS for three phase mains
- PFC

Description

The STC08IE150HV is manufactured in monolithic ESBT technology, aimed to provide best performance in high frequency / high voltage applications. it is designed for use in gate driven based topologies.

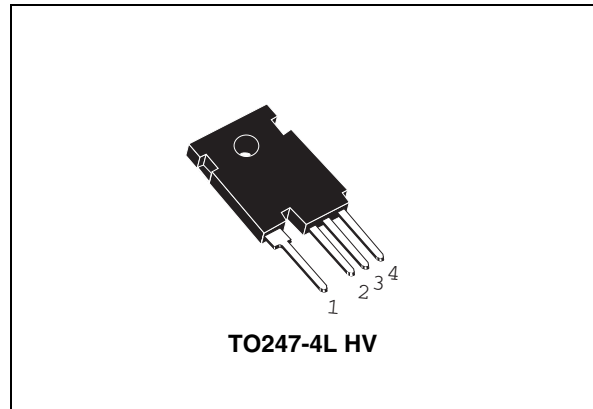

Figure 1. Internal schematic diagrams

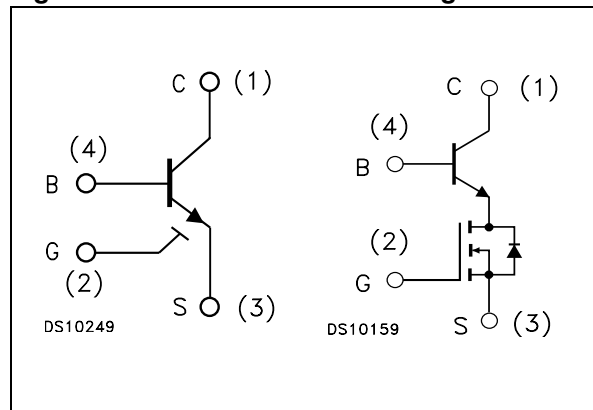

Table 1. Device summary

Part number	Marking	Package	Packaging
STC08IE150HV	C08IE150HV	TO247-4L HV	Tube

Contents

1	Electrical ratings	3
2	Electrical characteristics	4
	2.1 Electrical characteristics (curves)	6
3	Package mechanical data	8
4	Revision history	10

1 Electrical ratings

Table 2. Absolute maximum ratings

Symbol	Parameter	Value	Unit
$V_{CS(SS)}$	Collector-source voltage ($V_{BS} = V_{GS} = 0$)	1500	V
$V_{BS(OS)}$	Base-source voltage ($I_C = 0, V_{GS} = 0$)	30	V
$V_{SB(OS)}$	Source-base voltage ($I_C = 0, V_{GS} = 0$)	17	V
V_{GS}	Gate-source voltage	± 17	V
I_C	Collector current	8	A
I_{CM}	Collector peak current ($t_P < 1$ ms)	24	A
I_B	Base current	8	A
I_{BM}	Base peak current ($t_P < 1$ ms)	12	A
P_{tot}	Total dissipation at $T_C \leq 25^\circ\text{C}$	208	W
T_{stg}	Storage temperature	-40 to 150	$^\circ\text{C}$
T_J	Max. operating junction temperature	125	$^\circ\text{C}$

Table 3. Thermal data

Symbol	Parameter	Value	Unit
$R_{thj-case}$	Thermal resistance junction-case	max 0.6	$^\circ\text{C/W}$

2 Electrical characteristics

($T_{\text{case}} = 25^{\circ}\text{C}$ unless otherwise specified)

Table 4. Electrical characteristics

Symbol	Parameter	Test conditions	Min.	Typ.	Max.	Unit
$I_{\text{CS(SS)}}$	Collector-source cut-off current ($V_{\text{BS}} = V_{\text{GS}} = 0$)	$V_{\text{CS}} = 1500 \text{ V}$			100	μA
$I_{\text{BS(OS)}}$	Base-source cut-off current ($I_{\text{C}} = 0, V_{\text{GS}} = 0$)	$V_{\text{BS}} = 30 \text{ V}$			10	μA
$I_{\text{SB(OS)}}$	Source-base cut-off current ($I_{\text{C}} = 0, V_{\text{GS}} = 0$)	$V_{\text{SB}} = 17 \text{ V}$			100	μA
$I_{\text{GS(OS)}}$	Gate-source cut-off current ($I_{\text{C}} = 0; V_{\text{BS}} = 0$)	$V_{\text{GS}} = \pm 17 \text{ V}$			100	nA
$V_{\text{CS(ON)}}$	Collector-source on voltage	$V_{\text{GS}} = 10 \text{ V } I_{\text{C}} = 3 \text{ A } I_{\text{B}} = 0.3 \text{ A}$ $V_{\text{GS}} = 10 \text{ V } I_{\text{C}} = 8 \text{ A } I_{\text{B}} = 1.6 \text{ A}$		0.3 0.65	1.2 1.5	V V
h_{FE}	DC current gain	$V_{\text{GS}} = 10 \text{ V } V_{\text{CS}} = 1 \text{ V } I_{\text{C}} = 3 \text{ A}$ $V_{\text{GS}} = 10 \text{ V } V_{\text{CS}} = 1 \text{ V } I_{\text{C}} = 8 \text{ A}$	9 4.5	14 6.8		
$V_{\text{BS(ON)}}$	Base-source on voltage	$V_{\text{GS}} = 10 \text{ V } I_{\text{C}} = 3 \text{ A } I_{\text{B}} = 0.3 \text{ A}$ $V_{\text{GS}} = 10 \text{ V } I_{\text{C}} = 8 \text{ A } I_{\text{B}} = 1.6 \text{ A}$		1 1.7	1.5 2	V V
$V_{\text{GS(th)}}$	Gate threshold voltage	$V_{\text{BS}} = V_{\text{GS}} \quad I_{\text{B}} = 250 \mu\text{A}$	2	3	4	V
C_{iss}	Input capacitance	$V_{\text{CS}} = 25 \text{ V} \quad f = 1 \text{ MHz}$ $V_{\text{GS}} = V_{\text{CB}} = 0$		810		pF
$Q_{\text{GS(tot)}}$	Gate-source charge	$V_{\text{CS}} = 25 \text{ V} \quad V_{\text{GS}} = 10 \text{ V}$ $V_{\text{CB}} = 0 \quad I_{\text{C}} = 4 \text{ A}$		45		nC
t_{s} t_{f}	Inductive load Storage time Fall time	$V_{\text{GS}} = 10 \text{ V} \quad R_{\text{G}} = 4.7 \Omega$ $V_{\text{clamp}} = 1200\text{V} \quad t_{\text{p}} = 4 \mu\text{s}$ $I_{\text{C}} = 4 \text{ A} \quad I_{\text{B}} = 0.8 \text{ A}$		690 10		ns ns
t_{s} t_{f}	Inductive load Storage time Fall time	$V_{\text{GS}} = 10 \text{ V} \quad R_{\text{G}} = 4.7 \Omega$ $V_{\text{clamp}} = 1200 \text{ V} \quad t_{\text{p}} = 4 \mu\text{s}$ $I_{\text{C}} = 4 \text{ A} \quad I_{\text{B}} = 0.4 \text{ A}$		340 10		ns ns
$V_{\text{CS(dyn)}}$	Collector-source dynamic voltage (500 ns)	$V_{\text{CC}} = V_{\text{clamp}} = 600 \text{ V}$ $V_{\text{GS}} = 10 \text{ V} \quad I_{\text{C}} = 2 \text{ A}$ $I_{\text{B}} = 0.4 \text{ A} \quad R_{\text{G}} = 4.7 \Omega$ $t_{\text{(peak)}} = 500 \text{ ns} \quad I_{\text{B(peak)}} = 4 \text{ A}$		2.8		V

Table 4. Electrical characteristics (continued)

Symbol	Parameter	Test conditions	Min.	Typ.	Max.	Unit
$V_{CS(dyn)}$	Collector-source dynamic voltage (1 μ s)	$V_{CC} = V_{clamp} = 600$ V $V_{GS} = 10$ V $I_B = 0.4$ A $t_{(peak)} = 500$ ns $I_C = 2$ A $R_G = 4.7$ Ω $I_{B(peak)} = 4$ A		1.7		V
V_{CSW}	Maximum collector-source voltage switched without snubber	$R_G = 4.7$ Ω $h_{FE} = 5$ $I_C = 8$ A	1500			V

2.1 Electrical characteristics (curves)

Figure 2. Output characteristics

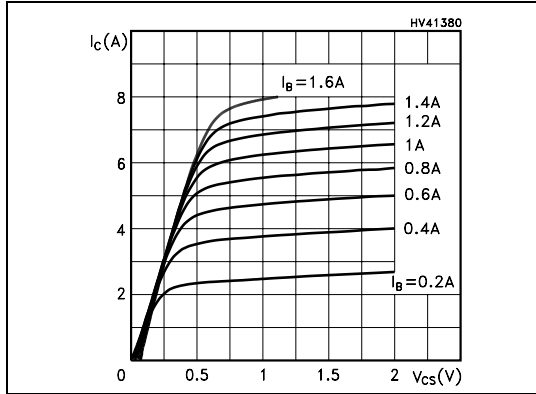

Figure 3. Gate threshold voltage vs temperature

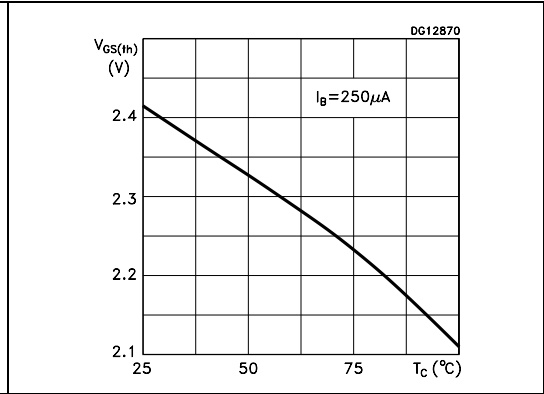

Figure 4. Reverse biased safe operating area

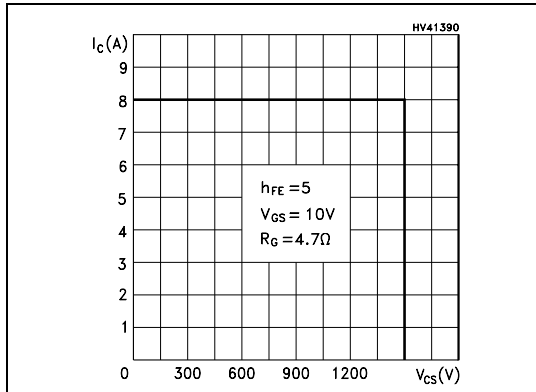

Figure 5. DC current gain

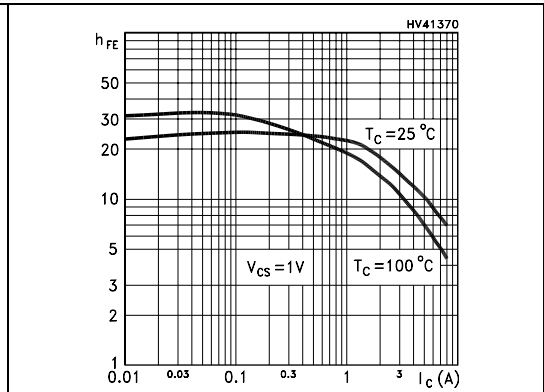

Figure 6. Collector-source voltage @ $h_{FE} = 5$

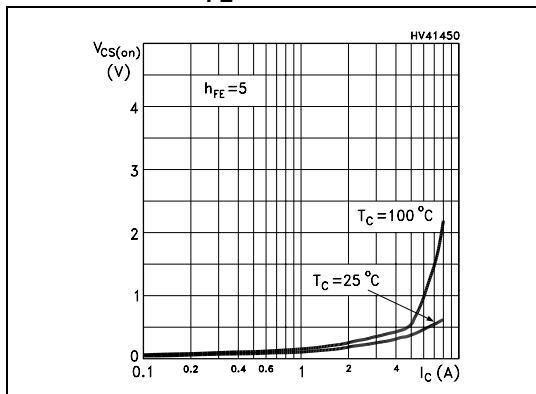

Figure 7. Collector-source voltage @ $h_{FE} = 10$

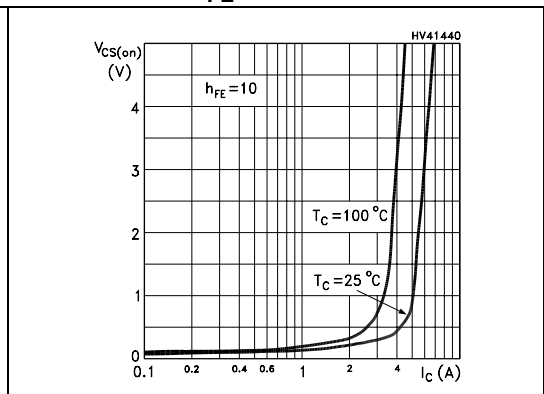

Figure 8. Base-source voltage @ $h_{FE}=5$

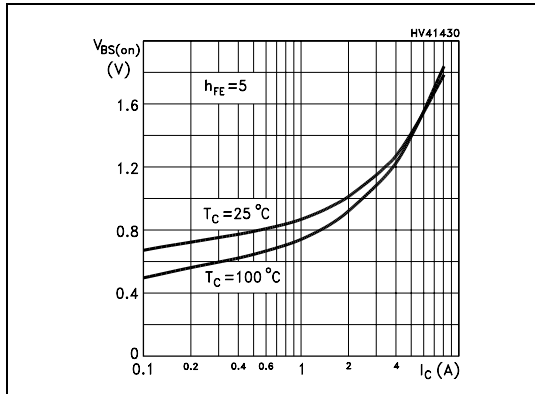

Figure 9. Base-source voltage @ $h_{FE}=10$

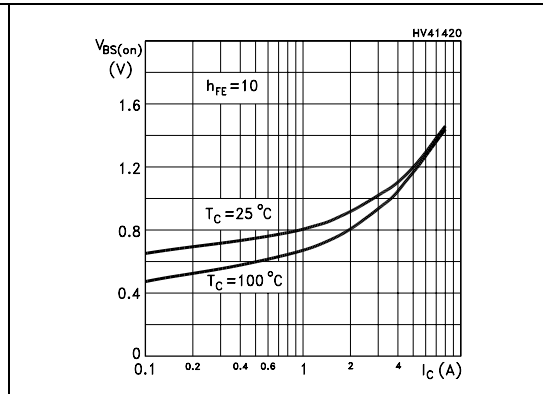

Figure 10. Inductive load switching time @ $h_{FE}=5$

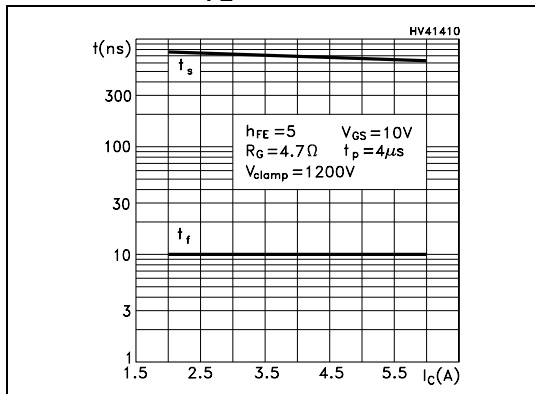

Figure 11. Inductive load switching time @ $h_{FE}=10$

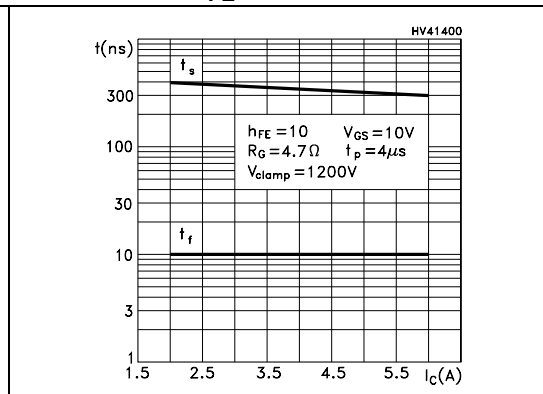
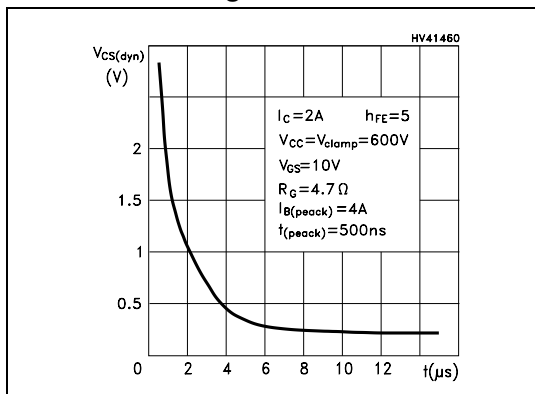

Figure 12. Dynamic collector-source voltage



3 Package mechanical data

In order to meet environmental requirements, ST offers these devices in ECOPACK® packages. These packages have a lead-free second level interconnect. The category of second level interconnect is marked on the package and on the inner box label, in compliance with JEDEC Standard JESD97. The maximum ratings related to soldering conditions are also marked on the inner box label. ECOPACK is an ST trademark. ECOPACK specifications are available at: www.st.com

TO247-4L HV MECHANICAL DATA

DIM.	mm.		
	MIN.	TYP	MAX.
A	4.85		5.15
A1	2.20	2.50	2.60
A2		1.27	
b	0.95	1.10	1.30
b2	2.50		2.90
c	0.40		0.80
D	23.85	24	24.15
D1		21.50	
E	15.45	15.60	15.75
e	2.54		
e1	5.08		
L	10.20		10.80
L1	2.20	2.50	2.80
L2		18.50	
L3		3	
∅P	3.55		3.65
S		5.50	

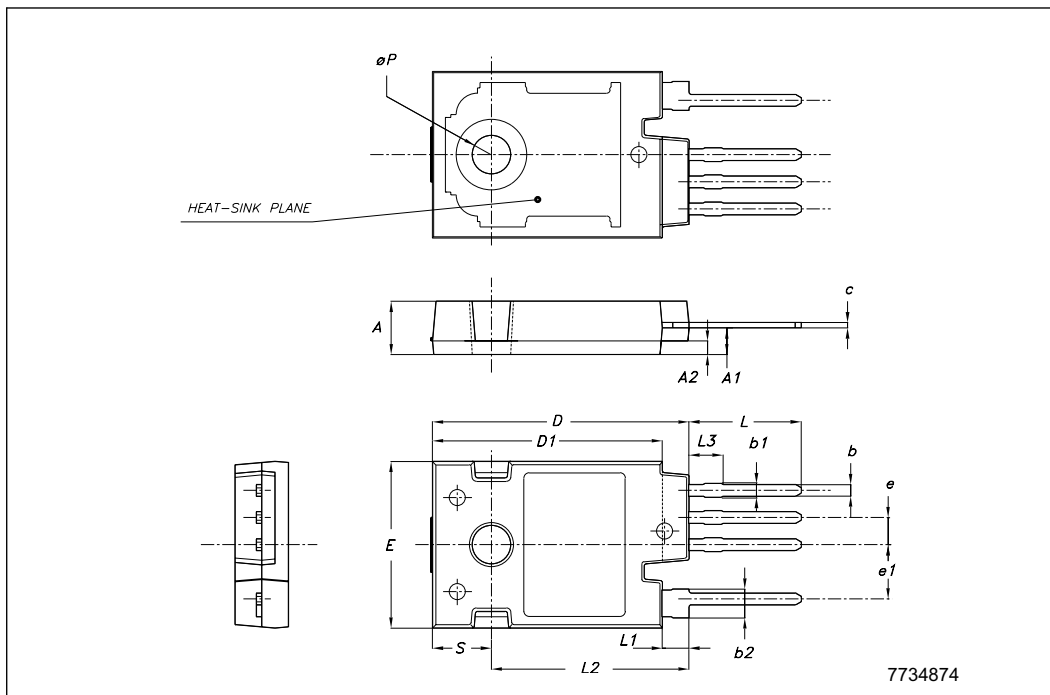

4 Revision history

Table 5. Document revision history

Date	Revision	Changes
30-Jan-2006	1	First release
01-Dec-2006	2	The document has been reformatted, no content change
22-Nov-2007	3	Document status promoted from preliminary data to datasheet. Added Section 2.1: Electrical characteristics (curves)

Please Read Carefully:

Information in this document is provided solely in connection with ST products. STMicroelectronics NV and its subsidiaries ("ST") reserve the right to make changes, corrections, modifications or improvements, to this document, and the products and services described herein at any time, without notice.

All ST products are sold pursuant to ST's terms and conditions of sale.

Purchasers are solely responsible for the choice, selection and use of the ST products and services described herein, and ST assumes no liability whatsoever relating to the choice, selection or use of the ST products and services described herein.

No license, express or implied, by estoppel or otherwise, to any intellectual property rights is granted under this document. If any part of this document refers to any third party products or services it shall not be deemed a license grant by ST for the use of such third party products or services, or any intellectual property contained therein or considered as a warranty covering the use in any manner whatsoever of such third party products or services or any intellectual property contained therein.

UNLESS OTHERWISE SET FORTH IN ST'S TERMS AND CONDITIONS OF SALE ST DISCLAIMS ANY EXPRESS OR IMPLIED WARRANTY WITH RESPECT TO THE USE AND/OR SALE OF ST PRODUCTS INCLUDING WITHOUT LIMITATION IMPLIED WARRANTIES OF MERCHANTABILITY, FITNESS FOR A PARTICULAR PURPOSE (AND THEIR EQUIVALENTS UNDER THE LAWS OF ANY JURISDICTION), OR INFRINGEMENT OF ANY PATENT, COPYRIGHT OR OTHER INTELLECTUAL PROPERTY RIGHT.

UNLESS EXPRESSLY APPROVED IN WRITING BY AN AUTHORIZED REPRESENTATIVE OF ST, ST PRODUCTS ARE NOT RECOMMENDED, AUTHORIZED OR WARRANTED FOR USE IN MILITARY, AIR CRAFT, SPACE, LIFE SAVING, OR LIFE SUSTAINING APPLICATIONS, NOR IN PRODUCTS OR SYSTEMS, WHERE FAILURE OR MALFUNCTION MAY RESULT IN PERSONAL INJURY, DEATH, OR SEVERE PROPERTY OR ENVIRONMENTAL DAMAGE. ST PRODUCTS WHICH ARE NOT SPECIFIED AS "AUTOMOTIVE GRADE" MAY ONLY BE USED IN AUTOMOTIVE APPLICATIONS AT USER'S OWN RISK.

Resale of ST products with provisions different from the statements and/or technical features set forth in this document shall immediately void any warranty granted by ST for the ST product or service described herein and shall not create or extend in any manner whatsoever, any liability of ST.

ST and the ST logo are trademarks or registered trademarks of ST in various countries.

Information in this document supersedes and replaces all information previously supplied.

The ST logo is a registered trademark of STMicroelectronics. All other names are the property of their respective owners.

© 2007 STMicroelectronics - All rights reserved

STMicroelectronics group of companies

Australia - Belgium - Brazil - Canada - China - Czech Republic - Finland - France - Germany - Hong Kong - India - Israel - Italy - Japan - Malaysia - Malta - Morocco - Singapore - Spain - Sweden - Switzerland - United Kingdom - United States of America

www.st.com

