

# FDMA520PZ

## Single P-Channel PowerTrench® MOSFET

-20V, -7.3A, 30mΩ

### Features

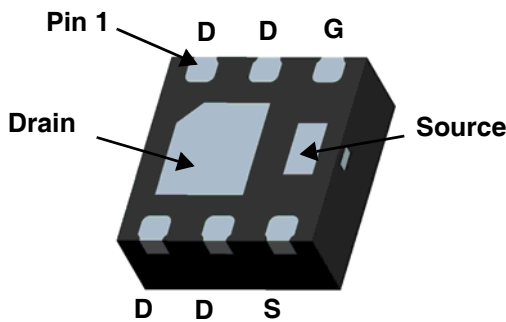
- Max  $r_{DS(on)}$  = 30mΩ at  $V_{GS} = -4.5V$ ,  $I_D = -7.3A$
- Max  $r_{DS(on)}$  = 53mΩ at  $V_{GS} = -2.5V$ ,  $I_D = -5.5A$
- Low profile - 0.8mm maximum - in the new package MicroFET 2X2 mm
- HBM ESD protection level > 3kV typical (Note 3)
- RoHS Compliant



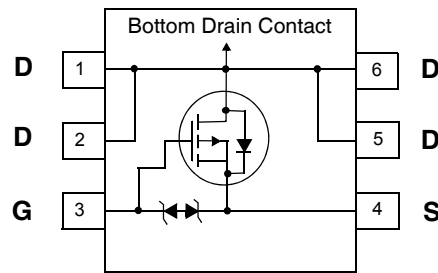
### General Description

This device is designed specifically for battery charge or load switching in cellular handset and other ultraportable applications. It features a MOSFET with low on-state resistance.

The MicroFET 2X2 package offers exceptional thermal performance for its physical size and is well suited to linear mode applications.



MicroFET 2X2 (Bottom View)



### MOSFET Maximum Ratings $T_A = 25^\circ C$ unless otherwise noted

Symbol	Parameter	Ratings	Units
$V_{DS}$	Drain to Source Voltage	-20	V
$V_{GS}$	Gate to Source Voltage	±12	V
$I_D$	Drain Current -Continuous (Note 1a)	-7.3	A
	-Pulsed	-24	
$P_D$	Power Dissipation (Note 1a)	2.4	W
	Power Dissipation (Note 1b)	0.9	
$T_J, T_{STG}$	Operating and Storage Junction Temperature Range	-55 to +150	°C

### Thermal Characteristics

$R_{\theta JA}$	Thermal Resistance, Junction to Ambient (Note 1a)	52	°C/W
$R_{\theta JA}$	Thermal Resistance, Junction to Ambient (Note 1b)	145	

### Package Marking and Ordering Information

Device Marking	Device	Package	Reel Size	Tape Width	Quantity
520	FDMA520PZ	MicroFET 2X2	7"	8mm	3000 units

## Electrical Characteristics $T_J = 25^\circ\text{C}$ unless otherwise noted

Symbol	Parameter	Test Conditions	Min	Typ	Max	Units
--------	-----------	-----------------	-----	-----	-----	-------

### Off Characteristics

$BV_{DSS}$	Drain to Source Breakdown Voltage	$I_D = -250\mu\text{A}, V_{GS} = 0\text{V}$	-20			V
$\frac{\Delta BV_{DSS}}{\Delta T_J}$	Breakdown Voltage Temperature Coefficient	$I_D = -250\mu\text{A}$ , referenced to $25^\circ\text{C}$		-8.4		mV/°C
$I_{DSS}$	Zero Gate Voltage Drain Current	$V_{DS} = -16\text{V}, V_{GS} = 0\text{V}$			-1	$\mu\text{A}$
$I_{GSS}$	Gate to Source Leakage Current	$V_{GS} = \pm 12\text{V}, V_{DS} = 0\text{V}$			$\pm 10$	$\mu\text{A}$

### On Characteristics

$V_{GS(th)}$	Gate to Source Threshold Voltage	$V_{GS} = V_{DS}, I_D = -250\mu\text{A}$	-0.6	-1.1	-1.5	V
$\frac{\Delta V_{GS(th)}}{\Delta T_J}$	Gate to Source Threshold Voltage Temperature Coefficient	$I_D = -250\mu\text{A}$ , referenced to $25^\circ\text{C}$		3.5		mV/°C
$r_{DS(on)}$	Static Drain to Source On Resistance	$V_{GS} = -4.5\text{V}, I_D = -7.3\text{A}$		26	30	m $\Omega$
		$V_{GS} = -2.5\text{V}, I_D = -5.5\text{A}$		42	53	
		$V_{GS} = -4.5\text{V}, I_D = -7.3\text{A}, T_J = 125^\circ\text{C}$		36	55	
$g_{FS}$	Forward Transconductance	$V_{DS} = -5\text{V}, I_D = -7.3\text{A}$		22		S

### Dynamic Characteristics

$C_{iss}$	Input Capacitance	$V_{DS} = -10\text{V}, V_{GS} = 0\text{V}, f = 1\text{MHz}$		1235	1645	pF
$C_{oss}$	Output Capacitance			255	340	pF
$C_{rss}$	Reverse Transfer Capacitance			225	340	pF

### Switching Characteristics

$t_{d(on)}$	Turn-On Delay Time	$V_{DD} = -10\text{V}, I_D = -7.3\text{A}, V_{GS} = -4.5\text{V}, R_{GEN} = 6\Omega$		10	20	ns
$t_r$	Rise Time			29	47	ns
$t_{d(off)}$	Turn-Off Delay Time			83	133	ns
$t_f$	Fall Time			74	119	ns
$Q_g$	Total Gate Charge	$V_{DD} = -5\text{V}, I_D = -7.3\text{A}, V_{GS} = -4.5\text{V}$		14	20	nC
$Q_{gs}$	Gate to Source Gate Charge			2.9		nC
$Q_{gd}$	Gate to Drain "Miller" Charge			4.4		nC

### Drain-Source Diode Characteristics

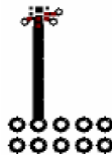
$I_S$	Maximum Continuous Drain-Source Diode Forward Current				-2	A
$V_{SD}$	Source to Drain Diode Forward Voltage	$V_{GS} = 0\text{V}, I_S = -2\text{A}$		-0.8	-1.2	V
$t_{rr}$	Reverse Recovery Time	$I_F = -7.3\text{A}, di/dt = 100\text{A}/\mu\text{s}$		30	45	ns
$Q_{rr}$	Reverse Recovery Charge			22	33	nC

#### Notes:

1:  $R_{\theta JA}$  is the sum of the junction-to-case and case-to-ambient thermal resistance where the case thermal reference is defined as the solder mounting surface of the drain pins.



a.  $52^\circ\text{C/W}$  when mounted on a  $1\text{ in}^2$  pad of 2 oz copper

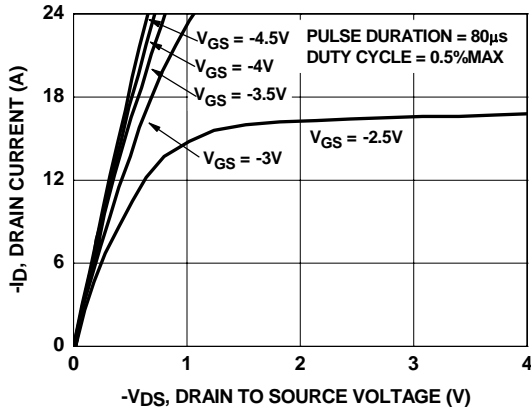


b.  $145^\circ\text{C/W}$  when mounted on a minimum pad of 2 oz copper

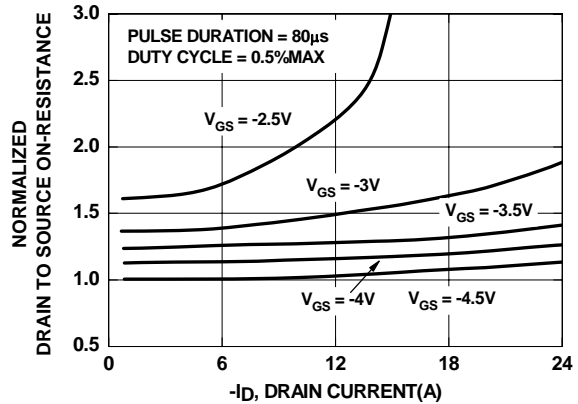
2: Pulse Test: Pulse Width <  $300\mu\text{s}$ , Duty cycle < 2.0%.

3: The diode connected between the gate and the source serves only as protection against ESD. No gate overvoltage rating is implied.

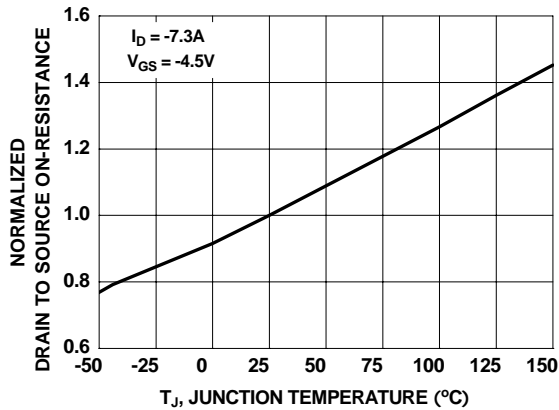
**Typical Characteristics**  $T_J = 25^\circ\text{C}$  unless otherwise noted



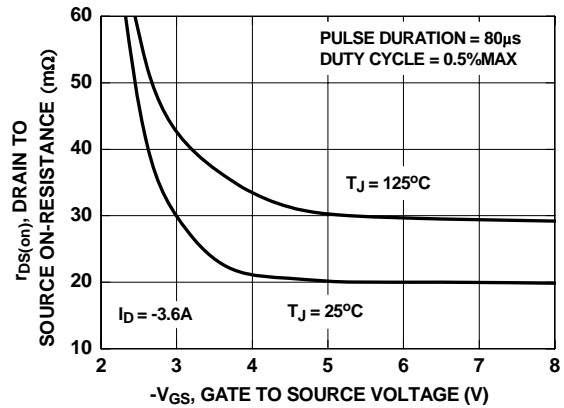
**Figure 1. On-Region Characteristics**



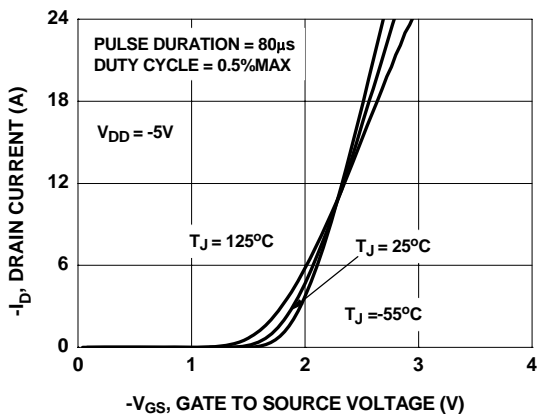
**Figure 2. Normalized On-Resistance vs Drain Current and Gate Voltage**



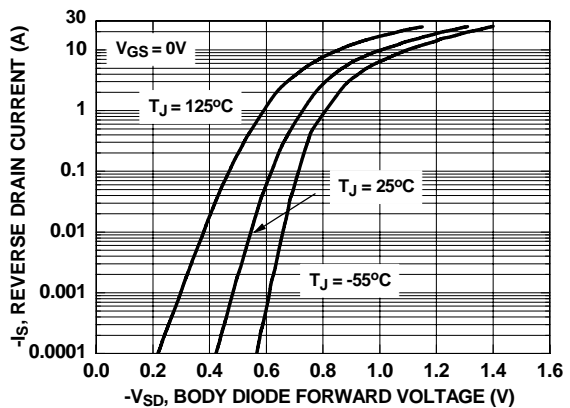
**Figure 3. Normalized On-Resistance vs Junction Temperature**



**Figure 4. On-Resistance vs Gate to Source Voltage**

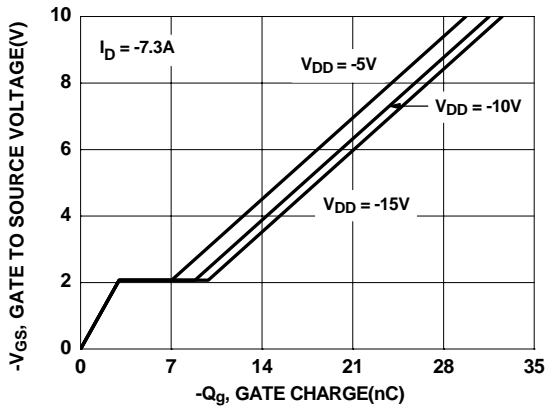


**Figure 5. Transfer Characteristics**

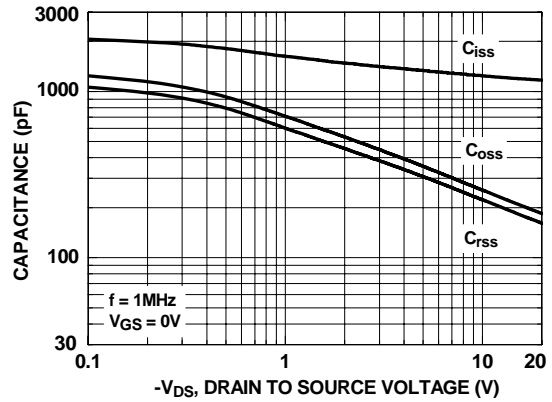


**Figure 6. Source to Drain Diode Forward Voltage vs Source Current**

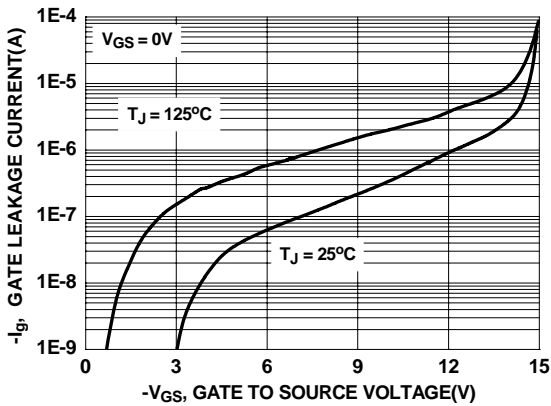
**Typical Characteristics**  $T_J = 25^\circ\text{C}$  unless otherwise noted



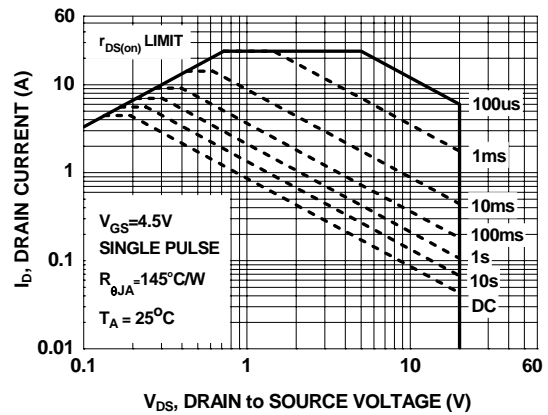
**Figure 7. Gate Charge Characteristics**



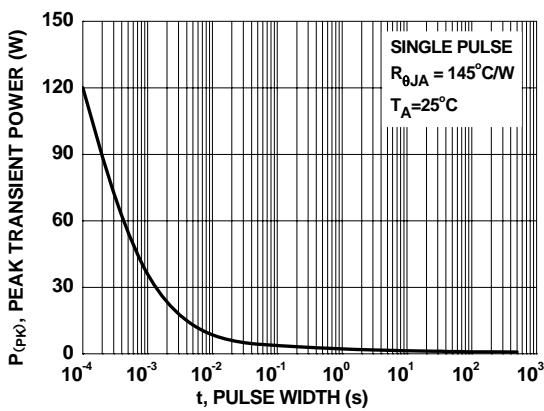
**Figure 8. Capacitance vs Drain to Source Voltage**



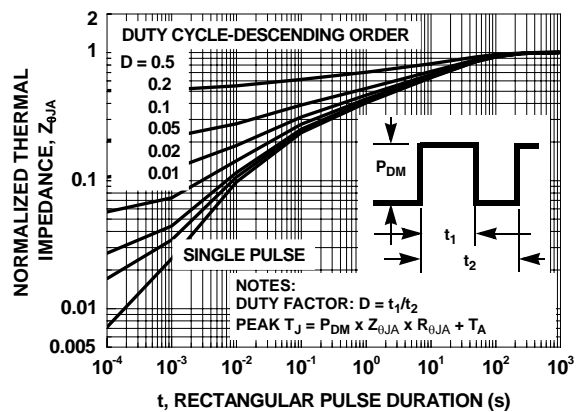
**Figure 9. Gate Leakage Current vs Gate to Source Voltage**



**Figure 10. Forward Bias Safe Operating Area**

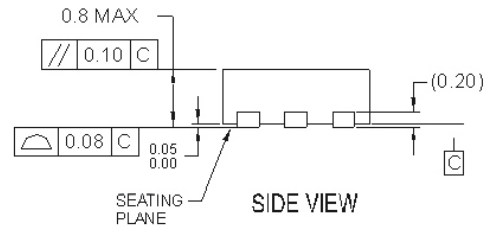
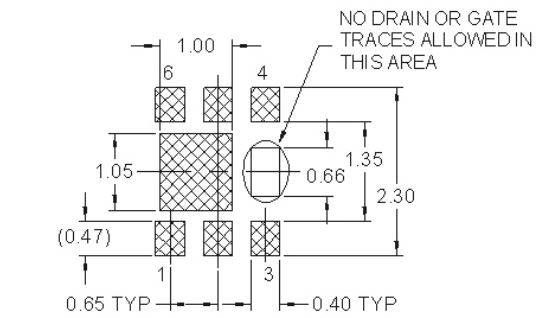
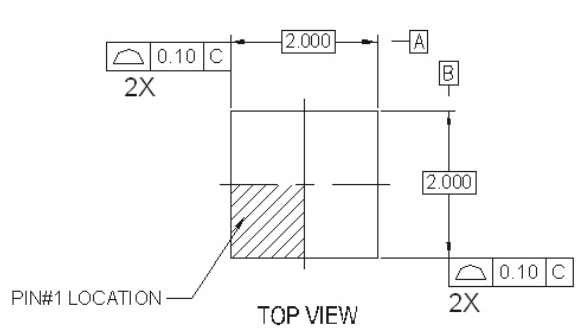


**Figure 11. Single Pulse Maximum Power Dissipation**

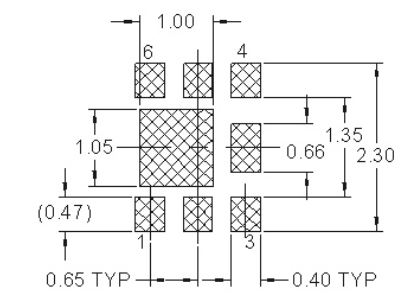
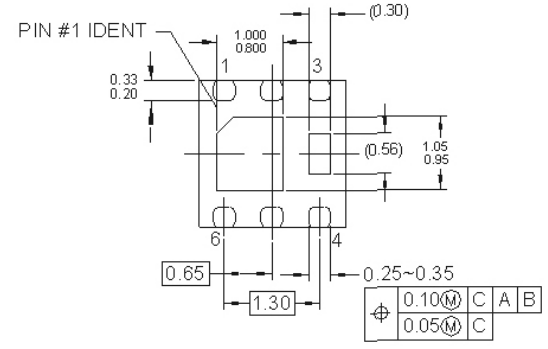


**Figure 12. Transient Thermal Response Curve**

### Dimensional Outline and Pad Layout



RECOMMENDED LAND PATTERN OPT 1



RECOMMENDED LAND PATTERN OPT 2






**NOTES:**

- A. DOES NOT FULLY CONFORM TO JEDEC REGISTRATION MO-229 DATED AUG/2003
- B. DIMENSIONS ARE IN MILLIMETERS.
- C. DIMENSIONS AND TOLERANCES PER ASME Y14.5M, 1994
- D. DRAWING FILENAME: MKT-MLP06Lrev2.



**TRADEMARKS**

The following includes registered and unregistered trademarks and service marks, owned by Fairchild Semiconductor and/or its global subsidiaries, and is not intended to be an exhaustive list of all such trademarks.

- |   |   |   |   |
|---|---|---|---|
| ACEx <sup>®</sup>   | FPS <sup>™</sup>  | PDP-SPM <sup>™</sup>  | The Power Franchise <sup>®</sup>  |
| Build it Now <sup>™</sup>   | F-PFS <sup>™</sup>  | Power-SPM <sup>™</sup>  | <b>power</b><br>the franchise   |
| CorePLUS <sup>™</sup>   | FRFET <sup>®</sup>  | PowerTrench <sup>®</sup>  | TinyBoost <sup>™</sup>  |
| CorePOWER <sup>™</sup>  | Global Power Resource <sup>SM</sup>   | Programmable Active Droop <sup>™</sup>  | TinyBuck <sup>™</sup>   |
| CROSSVOLT <sup>™</sup>  | Green FPS <sup>™</sup>  | QFET <sup>®</sup>   | TinyLogic <sup>®</sup>  |
| CTL <sup>™</sup>  | Green FPS <sup>™</sup> e-Series <sup>™</sup>                                      | QS <sup>™</sup>   | TINYOPTO <sup>™</sup>   |
| Current Transfer Logic <sup>™</sup>   | GTO <sup>™</sup>  | Quiet Series <sup>™</sup>   | TinyPower <sup>™</sup>  |
| EcoSPARK <sup>®</sup>   | IntelliMAX <sup>™</sup>   | RapidConfigure <sup>™</sup>   | TinyPWM <sup>™</sup>  |
| EfficientMax <sup>™</sup>   | ISOPLANAR <sup>™</sup>  | Saving our world 1mW at a time <sup>™</sup>                                       | TinyWire <sup>™</sup>   |
| EZSWITCH <sup>™</sup> *   | MegaBuck <sup>™</sup>   | SmartMax <sup>™</sup>   | μSerDes <sup>™</sup>  |
|  | MICROCOUPLER <sup>™</sup>   | SMART START <sup>™</sup>  |  |
|  | MicroFET <sup>™</sup>   | SPM <sup>®</sup>  | UHC <sup>®</sup>  |
| Fairchild <sup>®</sup>  | MicroPak <sup>™</sup>   | STEALTH <sup>™</sup>  | Ultra FRFET <sup>™</sup>  |
| Fairchild Semiconductor <sup>®</sup>  | MillerDrive <sup>™</sup>  | SuperFET <sup>™</sup>   | UniFET <sup>™</sup>   |
| FACT Quiet Series <sup>™</sup>  | MotionMax <sup>™</sup>  | SuperSOT <sup>™</sup> -3  | VCX <sup>™</sup>  |
| FACT <sup>®</sup>   | Motion-SPM <sup>™</sup>   | SuperSOT <sup>™</sup> -6  | VisualMax <sup>™</sup>  |
| FAST <sup>®</sup>   | OPTOLOGIC <sup>®</sup>  | SuperSOT <sup>™</sup> -8  |   |
| FastvCore <sup>™</sup>  | OPTOPLANAR <sup>®</sup>   | SuperMOS <sup>™</sup>   |   |
| FlashWriter <sup>®</sup> *  |  |  |   |

\* EZSWITCH<sup>™</sup> and FlashWriter<sup>®</sup> are trademarks of System General Corporation, used under license by Fairchild Semiconductor.

**DISCLAIMER**

FAIRCHILD SEMICONDUCTOR RESERVES THE RIGHT TO MAKE CHANGES WITHOUT FURTHER NOTICE TO ANY PRODUCTS HEREIN TO IMPROVE RELIABILITY, FUNCTION, OR DESIGN. FAIRCHILD DOES NOT ASSUME ANY LIABILITY ARISING OUT OF THE APPLICATION OR USE OF ANY PRODUCT OR CIRCUIT DESCRIBED HEREIN; NEITHER DOES IT CONVEY ANY LICENSE UNDER ITS PATENT RIGHTS, NOR THE RIGHTS OF OTHERS. THESE SPECIFICATIONS DO NOT EXPAND THE TERMS OF FAIRCHILD'S WORLDWIDE TERMS AND CONDITIONS, SPECIFICALLY THE WARRANTY THEREIN, WHICH COVERS THESE PRODUCTS.

**LIFE SUPPORT POLICY**

FAIRCHILD'S PRODUCTS ARE NOT AUTHORIZED FOR USE AS CRITICAL COMPONENTS IN LIFE SUPPORT DEVICES OR SYSTEMS WITHOUT THE EXPRESS WRITTEN APPROVAL OF FAIRCHILD SEMICONDUCTOR CORPORATION.

As used herein:

- Life support devices or systems are devices or systems which, (a) are intended for surgical implant into the body or (b) support or sustain life, and (c) whose failure to perform when properly used in accordance with instructions for use provided in the labeling, can be reasonably expected to result in a significant injury of the user.
- A critical component in any component of a life support, device, or system whose failure to perform can be reasonably expected to cause the failure of the life support device or system, or to affect its safety or effectiveness.

**PRODUCT STATUS DEFINITIONS**

**Definition of Terms**

Datasheet Identification	Product Status	Definition
Advance Information	Formative or In Design	This datasheet contains the design specifications for product development. Specifications may change in any manner without notice.
Preliminary	First Production	This datasheet contains preliminary data; supplementary data will be published at a later date. Fairchild Semiconductor reserves the right to make changes at any time without notice to improve design.
No Identification Needed	Full Production	This datasheet contains final specifications. Fairchild Semiconductor reserves the right to make changes at any time without notice to improve the design.
Obsolete	Not In Production	This datasheet contains specifications on a product that is discontinued by Fairchild Semiconductor. The datasheet is for reference information only.

Rev. I34