

RoHS Compliant Product

## Description

The SSG9435 provide the designer with the best Combination of fast switching, ruggedized device design, Ultra low on-resistance and cost-effectiveness.

The SOP-8 is universally preferred for all commercial industrial surface mount application and suited for low voltage applications such as DC/DC converters.

## Features

- \* Low on-resistance
- \* Simple drive requirement
- \* Fast switching Characteristic

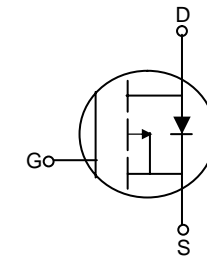
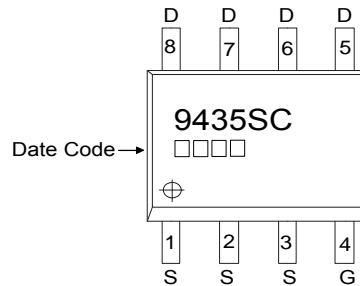

## SOP-8

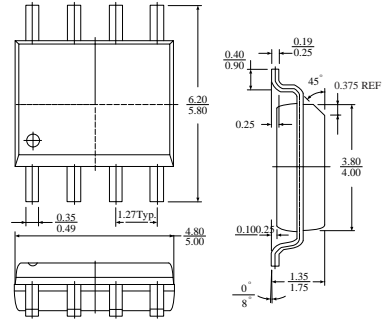

Dimensions in millimeters

## Absolute Maximum Ratings

Parameter	Symbol	Ratings	Unit
Drain-Source Voltage	V <sub>DS</sub>	-30	V
Gate-Source Voltage	V <sub>GS</sub>	±20	V
Continuous Drain Current,	I <sub>D</sub> @T <sub>A</sub> =25 °C	-5.3	A
Continuous Drain Current,	I <sub>D</sub> @T <sub>A</sub> =70 °C	-4.7	A
Pulsed Drain Current <sup>1</sup>	I <sub>DM</sub>	-20	A
Total Power Dissipation	P <sub>D</sub> @T <sub>A</sub> =25 °C	2.5	W
Linear Derating Factor		0.02	W/°C
Operating Junction and Storage Temperature Range	T <sub>J</sub> , T <sub>stg</sub>	-55~+150	°C

## Thermal Data

Parameter	Symbol	Ratings	Unit
Thermal Resistance Junction-ambient	R <sub>thj-a</sub>	50	°C/W

**Electrical Characteristics( T<sub>j</sub>=25 °C Unless otherwise specified)**

Parameter	Symbol	Min.	Typ.	Max.	Unit	Test Condition
Drain-Source Breakdown Voltage	BV <sub>DSS</sub>	-30	-	-	V	V <sub>GS</sub> =0V, I <sub>D</sub> =-250uA
Breakdown Voltage Temp. Coefficient	ΔBV <sub>DSS</sub> /ΔT <sub>j</sub>	-	-0.037	-	V/°C	Reference to 25°C, I <sub>D</sub> =-1mA
Gate Threshold Voltage	V <sub>GS(th)</sub>	-1.0	-	-3.0	V	V <sub>DS</sub> =V <sub>GS</sub> , I <sub>D</sub> =-250uA
Gate-Source Leakage Current	I <sub>GSS</sub>	-	-	±100	nA	V <sub>GS</sub> =±20V
Drain-Source Leakage Current (T <sub>j</sub> =25°C)	I <sub>DSS</sub>	-	-	-1	uA	V <sub>DS</sub> =-30V, V <sub>GS</sub> =0
Drain-Source Leakage Current (T <sub>j</sub> =70°C)		-	-	-5	uA	V <sub>DS</sub> =-24V, V <sub>GS</sub> =0
Static Drain-Source On-Resistance <sup>2</sup>	R <sub>DS(ON)</sub>	-	-	50	mΩ	V <sub>GS</sub> =-10V, I <sub>D</sub> =-8A
		-	-	90		V <sub>GS</sub> =-4.5V, I <sub>D</sub> =-5A
Total Gate Charge <sup>2</sup>	Q <sub>g</sub>	-	28	-	nC	I <sub>D</sub> =-4.6A V <sub>DS</sub> =-15V V <sub>GS</sub> =-10V
Gate-Source Charge	Q <sub>gs</sub>	-	3	-		
Gate-Drain ("Miller") Charge	Q <sub>gd</sub>	-	7	-		
Turn-on Delay Time <sup>2</sup>	T <sub>d(ON)</sub>	-	-	9	nS	V <sub>DD</sub> =-15V I <sub>D</sub> =-1A V <sub>GS</sub> =-10V R <sub>G</sub> =6 Ω R <sub>D</sub> =15 Ω
Rise Time	T <sub>r</sub>	-	-	15		
Turn-off Delay Time	T <sub>d(OFF)</sub>	-	-	75		
Fall Time	T <sub>f</sub>	-	-	40		
Input Capacitance	C <sub>iss</sub>	-	-	745	pF	V <sub>GS</sub> =0V V <sub>DS</sub> =-15V f=1.0MHz
Output Capacitance	C <sub>oss</sub>	-	-	440		
Reverse Transfer Capacitance	C <sub>rss</sub>	-	-	350		
Forward Transconductance	G <sub>fs</sub>	-	20	-	S	V <sub>DS</sub> =-10V, I <sub>D</sub> =-8A

**Source-Drain Diode**

Parameter	Symbol	Min.	Typ.	Max.	Unit	Test Condition
Forward On Voltage <sup>2</sup>	V <sub>DS</sub>	-	-0.75	-1.2	V	I <sub>S</sub> =-2.1A, V <sub>GS</sub> =0V.
Continuous Source Current (Body Diode)	I <sub>S</sub>	-	-	-2.1	A	V <sub>D</sub> =V <sub>G</sub> =0V, V <sub>S</sub> =-1.2V
Pulsed Source Current (Body Diode)	I <sub>SM</sub>	-	-	-50	A	

Notes: 1.Pulse width limited by safe operating area.

2.Pulse width ≤300us, dutycycle≤2%.

## Characteristics Curve

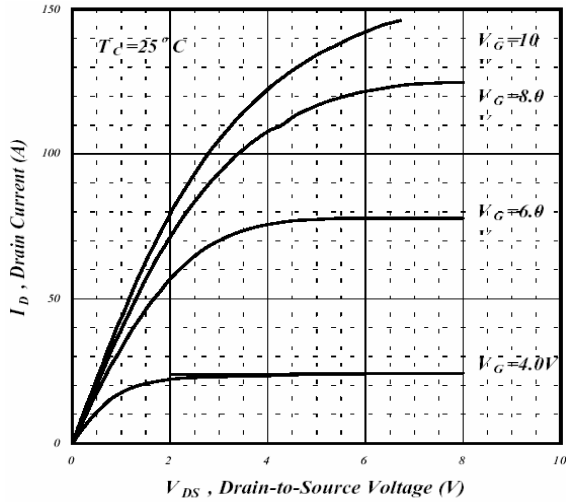

Fig 1. Typical Output Characteristics

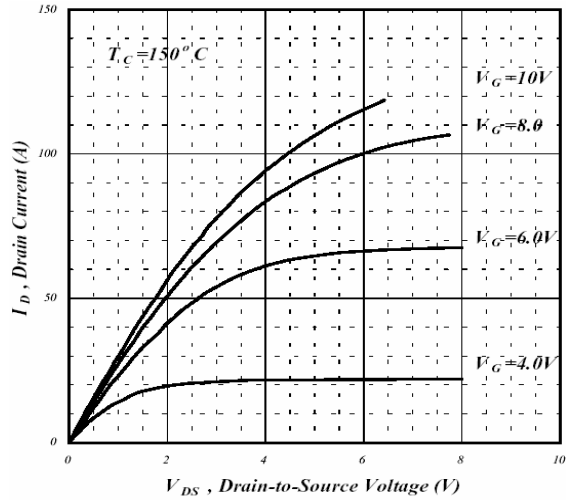

Fig 2. Typical Output Characteristics

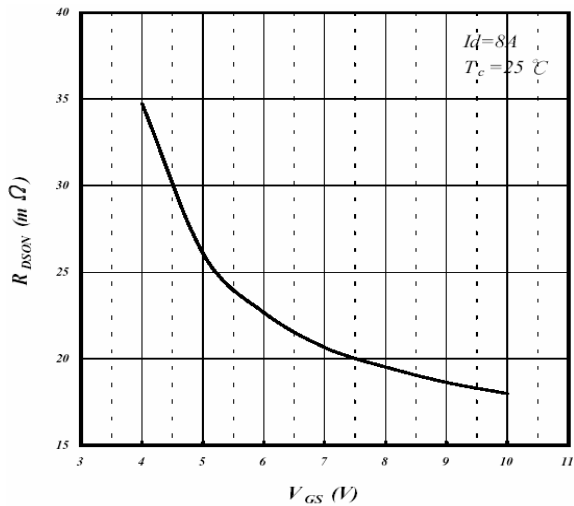

Fig 3. On-Resistance v.s. Gate Voltage

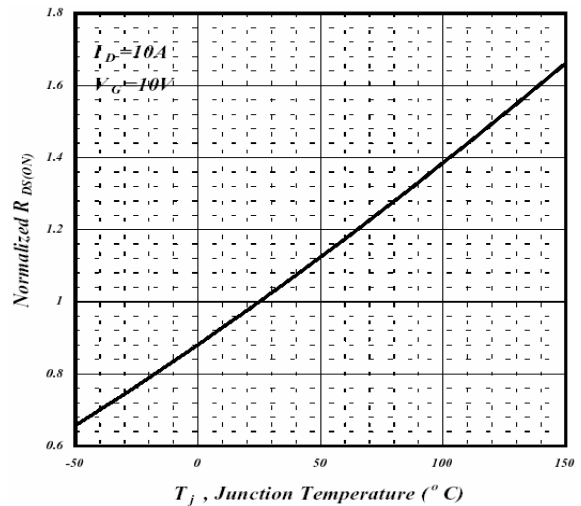

Fig 4. Normalized On-Resistance v.s. Junction Temperature

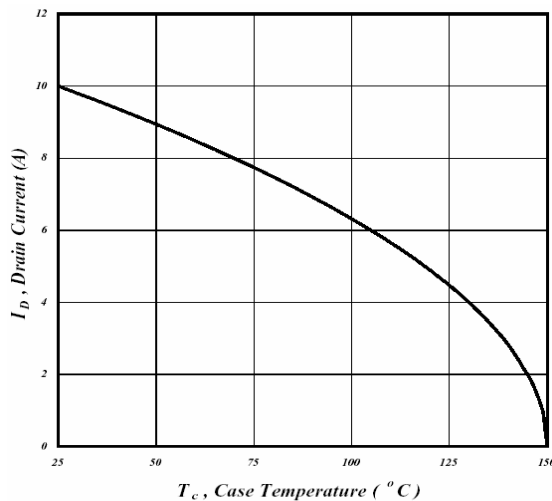

Fig 5. Maximum Drain Current v.s. Case Temperature

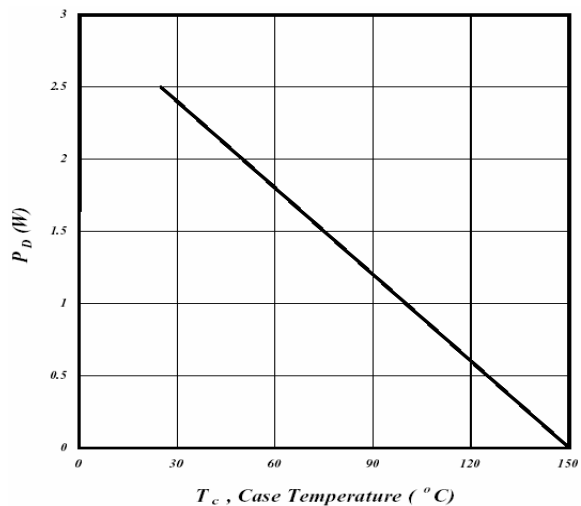

Fig 6. Type Power Dissipation

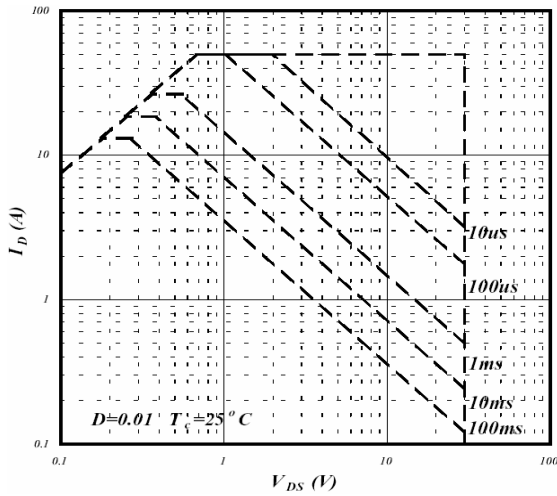

Fig 7. Maximum Safe Operating Area

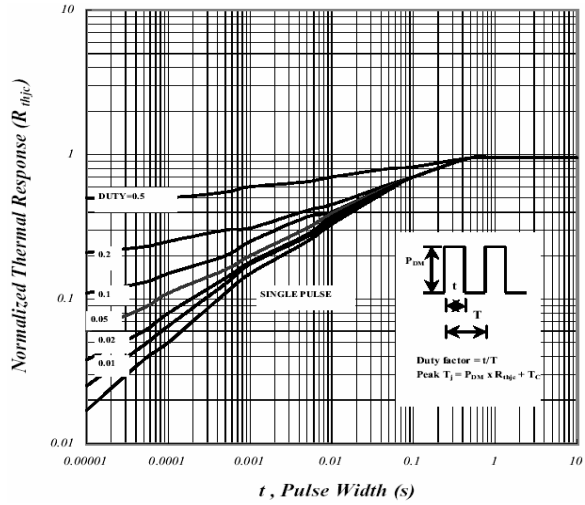

Fig 8. Effective Transient Thermal Impedance

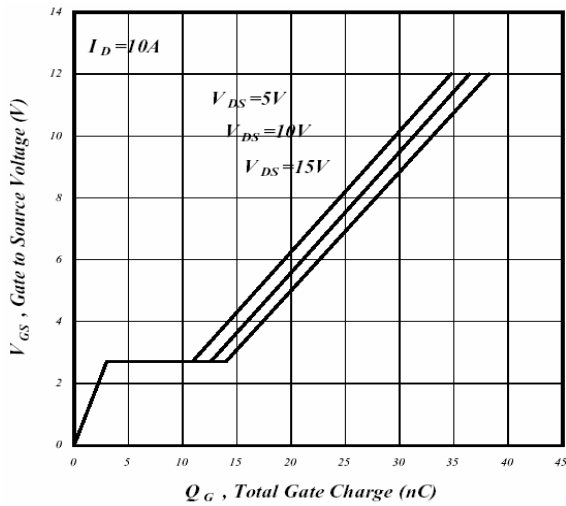

Fig 9. Gate Charge Characteristics

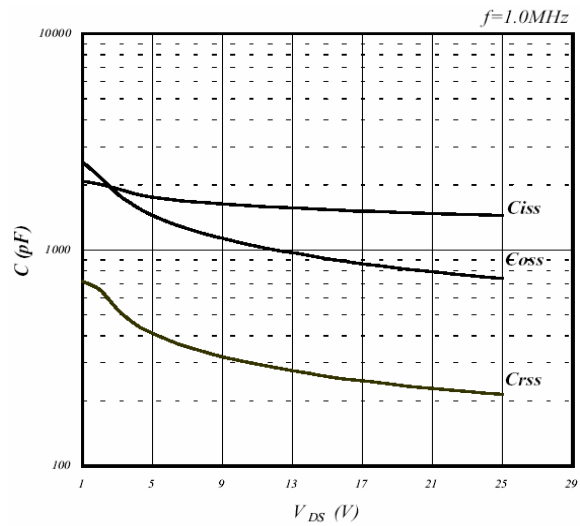

Fig 10. Typical Capacitance Characteristics

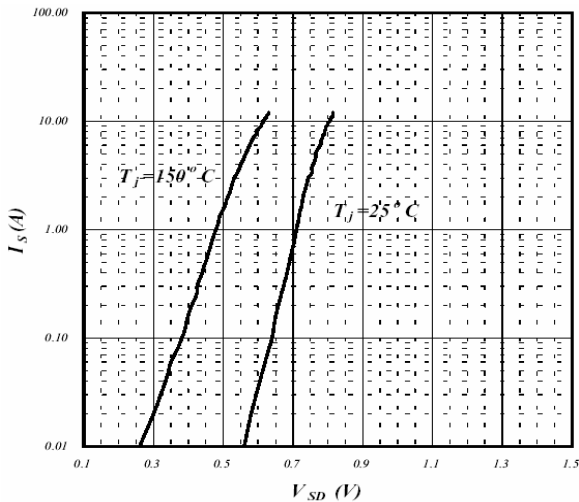

Fig 11. Forward Characteristics of Reverse Diode

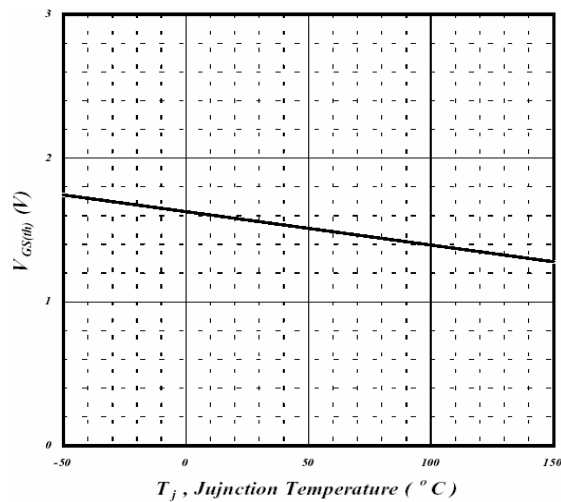

Fig 12. Gate Threshold Voltage v.s. Junction Temperature

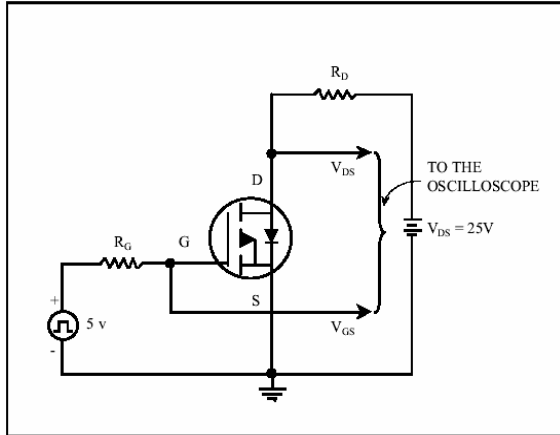

Fig 13. Switching Time Circuit

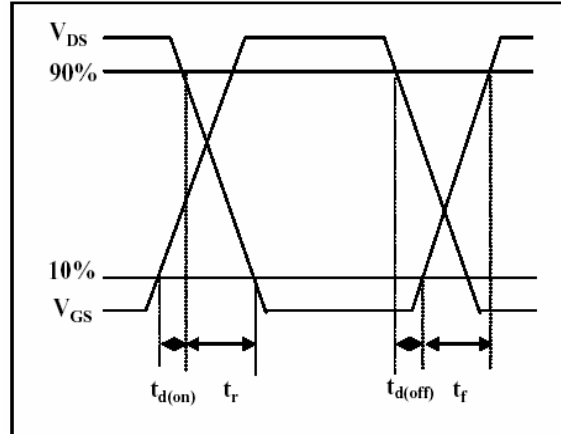

Fig 14. Switching Time Waveform

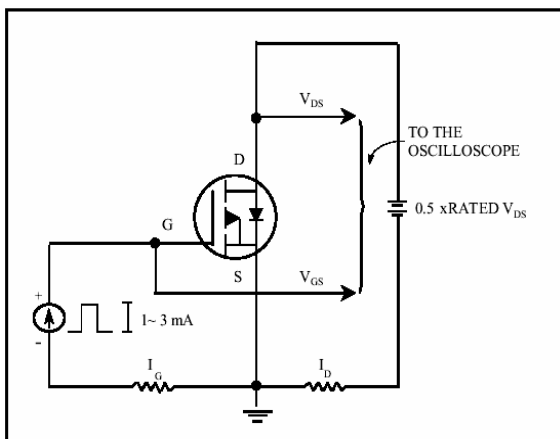

Fig 15. Gate Charge Circuit

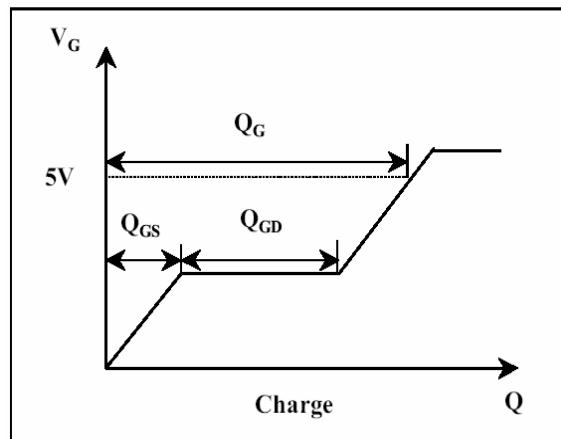

Fig 16. Gate Charge Waveform