

# 2SC5945

## Si NPN Epitaxial High Frequency Medium Power Amplifier

REJ03G0443-0300

Rev.3.00

Aug 03, 2006

### Features

- Excellent Linearity  
P1dB at output = +26 dBm typ. f = 2.4 GHz
- High Collector to Emitter Voltage  
 $V_{CEO} = 5\text{ V}$
- Ideal for 2 GHz Band applications. e.g. 2.4 GHz WLAN, Digital cordless phone.
- 7 Pin, Lead less, Small mounting area (HWSON-6: 2.0 x 2.0 x 0.8 mm).

### Outline

RENESAS Package code: PWSN0006JA-A  
(Package name: HWSON-6 <TNP-6DTV>)

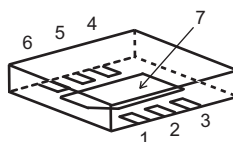
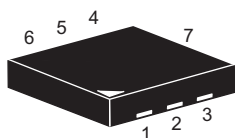

1. Collector
2. Collector
3. Collector
4. Emitter
5. Base
6. Emitter
7. Emitter

Note: Marking is "5945".

### Absolute Maximum Ratings

( $T_a = 25^\circ\text{C}$ )

Item	Symbol	Ratings	Unit
Collector to base voltage	$V_{CBO}$	13	V
Collector to emitter voltage	$V_{CEO}$	5	V
Emitter to base voltage	$V_{EBO}$	1.5	V
Collector current	$I_C$	500	mA
Collector power dissipation	$P_C$	1 <sup>Note</sup>	W
Junction temperature	$T_j$	150	$^\circ\text{C}$
Storage temperature	$T_{stg}$	-55 to +150	$^\circ\text{C}$

Note: Value on PCB (40 x 40 x 1.0 mm)

**Electrical Characteristics**

(Ta = 25°C)

Item	Symbol	Min	Typ	Max	Unit	Test Conditions
DC current transfer ratio	$h_{FE}$	110	150	190	—	$V_{CE} = 3\text{ V}, I_C = 100\text{ mA}$
Reverse Transfer Capacitance	$C_{re}$	—	1.0	—	pF	$V_{CB} = 2\text{ V}, I_E = 0, f = 1\text{ MHz}$ , emitter grounded
Transition Frequency	$f_T$	—	15.5	—	GHz	$V_{CE} = 3\text{ V}, I_C = 100\text{ mA}$ , $f = 1\text{ GHz}$
Maximum Available Gain	MAG	—	9	—	dB	$V_{CE} = 3\text{ V}, I_C = 100\text{ mA}$ , $f = 2.4\text{ GHz}$
Power Gain	PG	4	6	—	dB	$V_{CE} = 3.3\text{ V}, I_{Cq} = 100\text{ mA}$ , $f = 2.4\text{ GHz}$ , $P_{in} = +20\text{ dBm}$
Power Added Efficiency	PAE	30	40	—	%	$V_{CE} = 3.3\text{ V}, I_{Cq} = 100\text{ mA}$ , $f = 2.4\text{ GHz}$
1dB Compression Point at output	P1dB	—	+24	—	dBm	$V_{CE} = 3.3\text{ V}, I_{Cq} = 100\text{ mA}$ , $f = 2.4\text{ GHz}$
1dB Compression Point at output	P1dB	—	+26	—	dBm	$V_{CE} = 3.3\text{ V}, I_{Cq} = 250\text{ mA}$ , $f = 2.4\text{ GHz}$

**Main Characteristics**

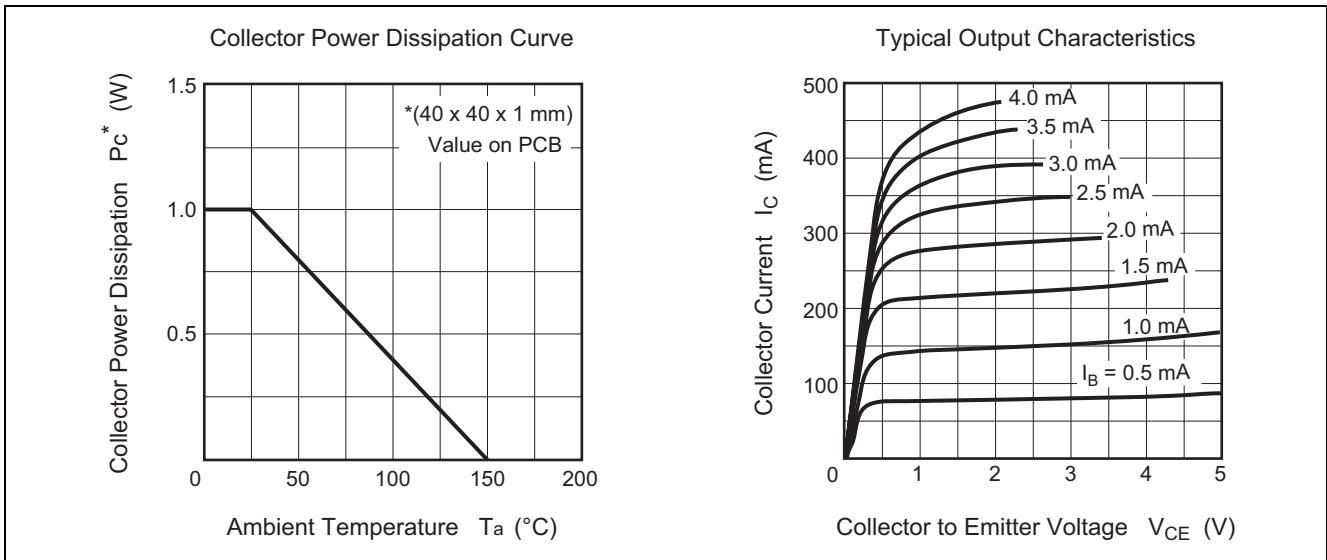

Typical Transfer Characteristics

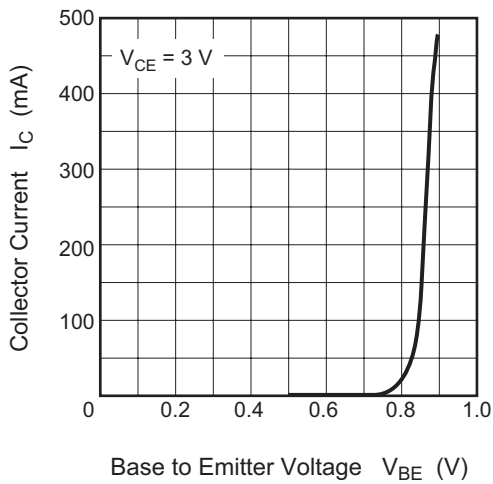

DC Current Transfer Ratio vs. Collector Current

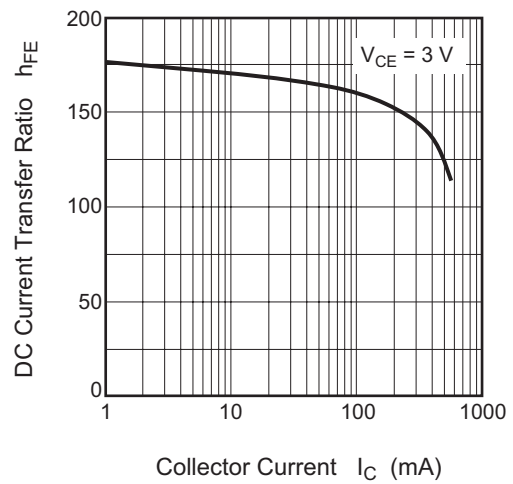

Reverse Transfer Capacitance vs. Collector to Base Voltage

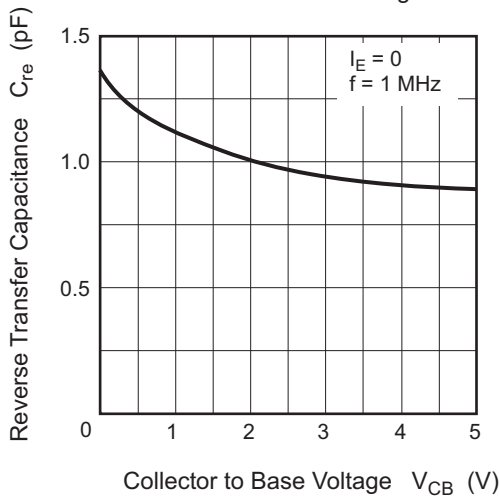

Transition Frequency vs. Collector Current

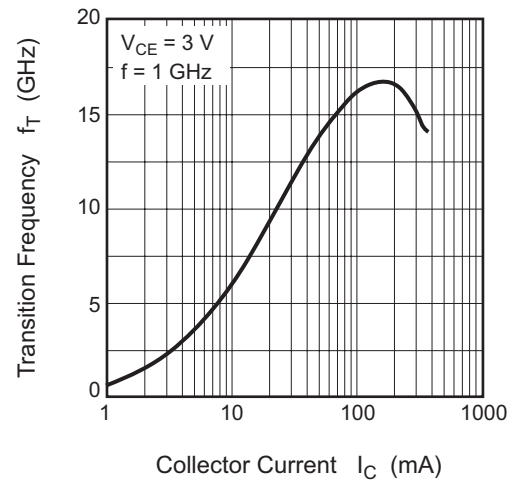

Maximum Available Gain, Maximum Stable Gain vs. Collector Current

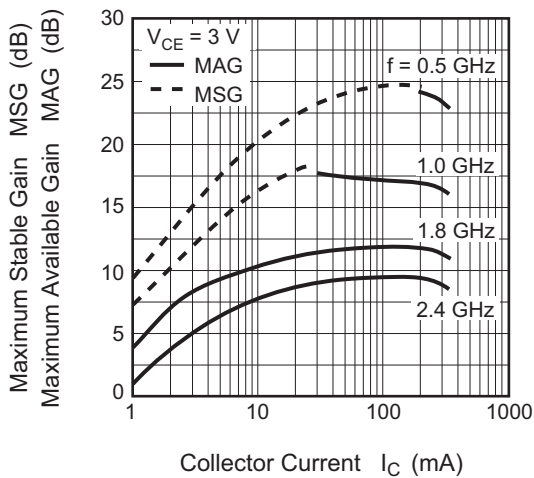

$S_{21}$  Parameter, Maximum Available Gain, Maximum Stable Gain vs. Frequency

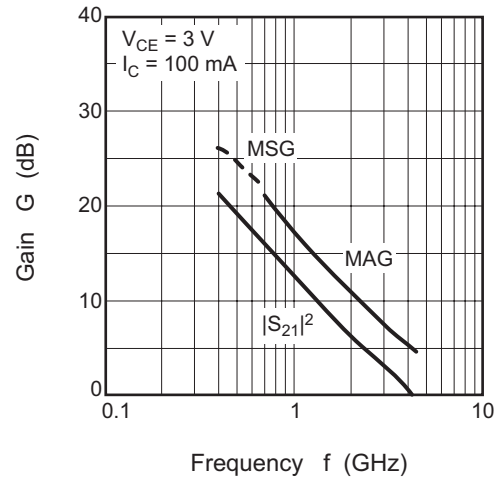

Pin-Pout Characteristics

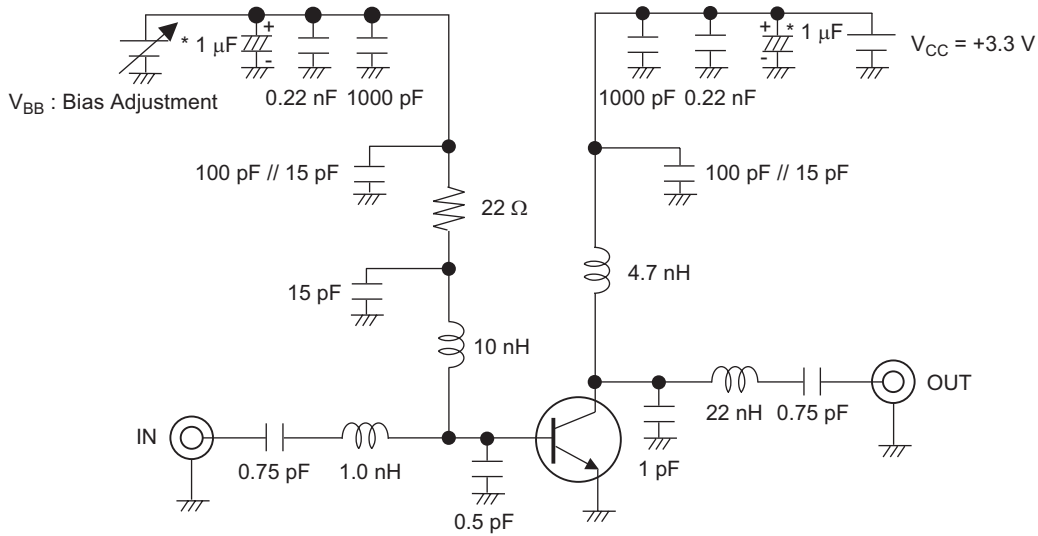

Output Power, Power Added Efficiency vs. Input Power

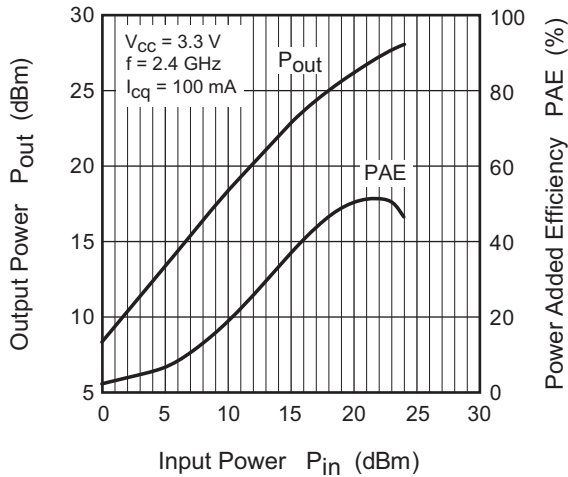

Output Power, Power Added Efficiency vs. Input Power

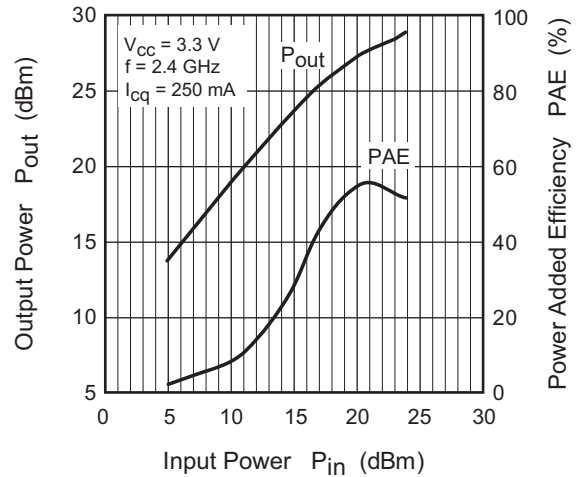

Power Gain vs. Input Power

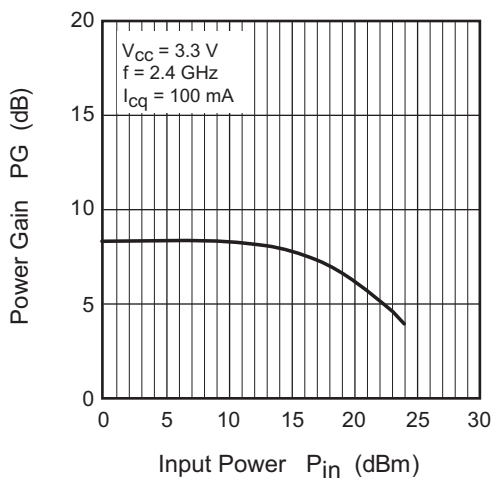

Power Gain vs. Input Power

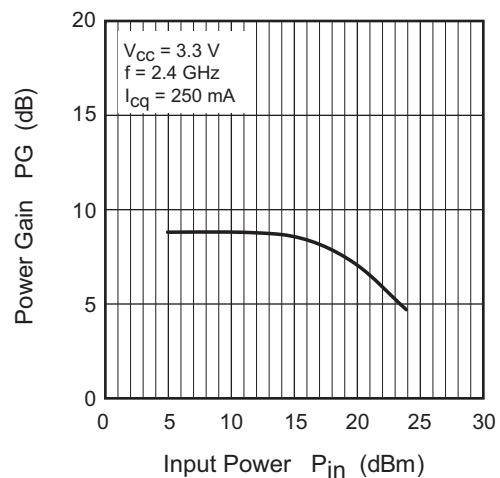

S<sub>11</sub> Parameter vs. Frequency

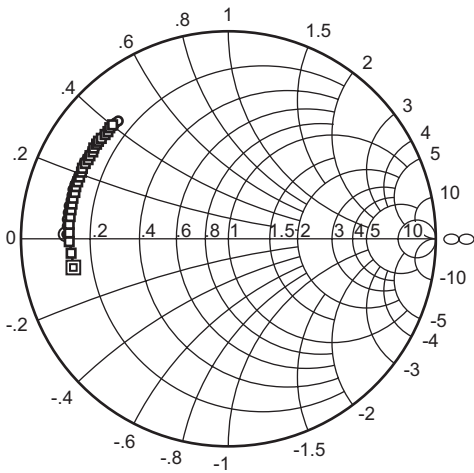

Condition:  $V_{CE} = 3\text{ V}$ ,  $Z_O = 50\ \Omega$   
 400 to 3000 MHz (100 MHz Step)  
 ○ (I<sub>C</sub> = 100 mA)  
 □ (I<sub>C</sub> = 250 mA)

S<sub>21</sub> Parameter vs. Frequency

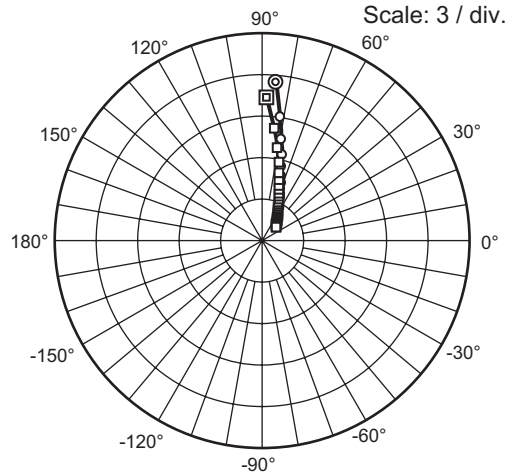

Condition:  $V_{CE} = 3\text{ V}$ ,  $Z_O = 50\ \Omega$   
 400 to 3000 MHz (100 MHz Step)  
 ○ (I<sub>C</sub> = 100 mA)  
 □ (I<sub>C</sub> = 250 mA)

S<sub>12</sub> Parameter vs. Frequency

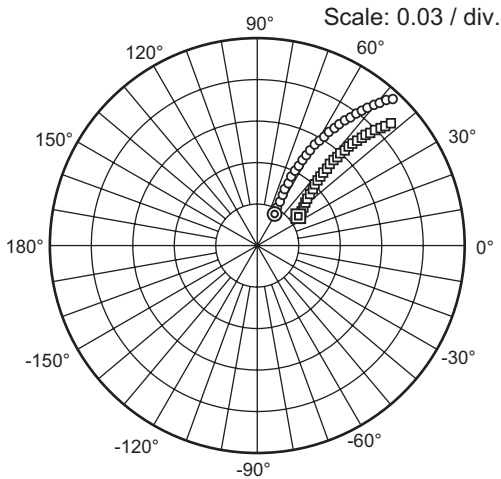

Condition:  $V_{CE} = 3\text{ V}$ ,  $Z_O = 50\ \Omega$   
 400 to 3000 MHz (100 MHz Step)  
 ○ (I<sub>C</sub> = 100 mA)  
 □ (I<sub>C</sub> = 250 mA)

S<sub>22</sub> Parameter vs. Frequency

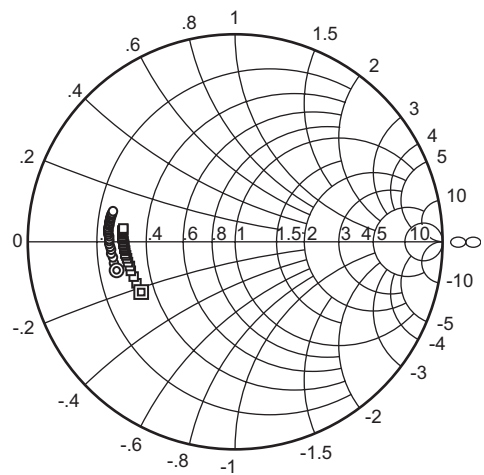

Condition:  $V_{CE} = 3\text{ V}$ ,  $Z_O = 50\ \Omega$   
 400 to 3000 MHz (100 MHz Step)  
 ○ (I<sub>C</sub> = 100 mA)  
 □ (I<sub>C</sub> = 250 mA)

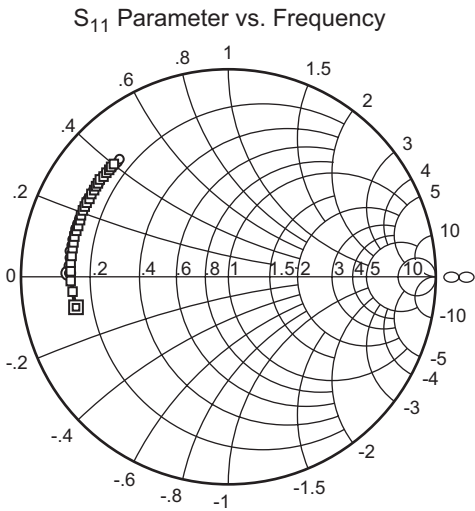

Condition:  $V_{CE} = 3.3\text{ V}$ ,  $Z_0 = 50\ \Omega$   
 400 to 3000 MHz (100 MHz Step)  
 ○ (  $I_C = 100\text{ mA}$  )  
 □ (  $I_C = 250\text{ mA}$  )

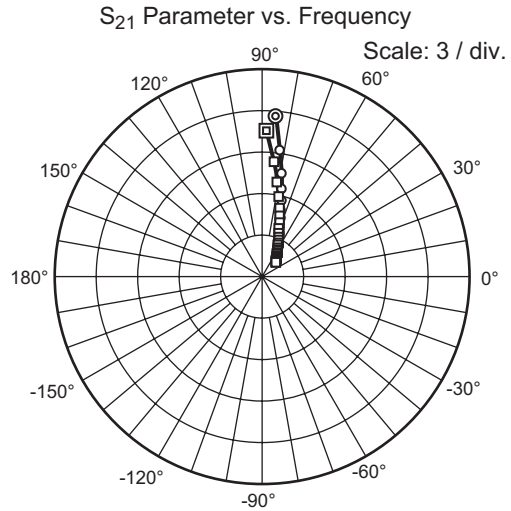

Condition:  $V_{CE} = 3.3\text{ V}$ ,  $Z_0 = 50\ \Omega$   
 400 to 3000 MHz (100 MHz Step)  
 ○ (  $I_C = 100\text{ mA}$  )  
 □ (  $I_C = 250\text{ mA}$  )

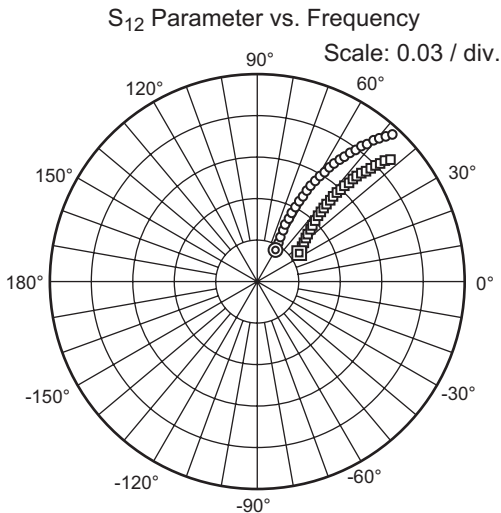

Condition:  $V_{CE} = 3.3\text{ V}$ ,  $Z_0 = 50\ \Omega$   
 400 to 3000 MHz (100 MHz Step)  
 ○ (  $I_C = 100\text{ mA}$  )  
 □ (  $I_C = 250\text{ mA}$  )

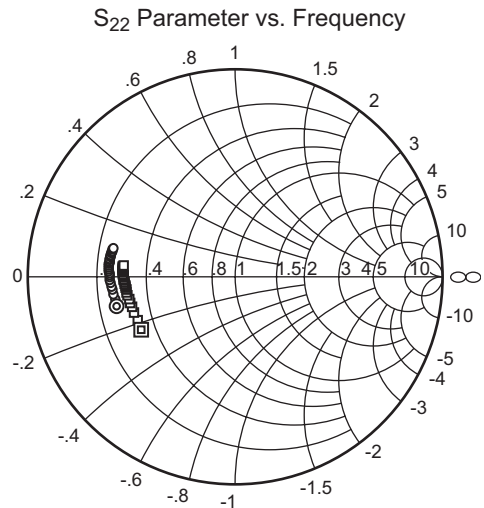

Condition:  $V_{CE} = 3.3\text{ V}$ ,  $Z_0 = 50\ \Omega$   
 400 to 3000 MHz (100 MHz Step)  
 ○ (  $I_C = 100\text{ mA}$  )  
 □ (  $I_C = 250\text{ mA}$  )

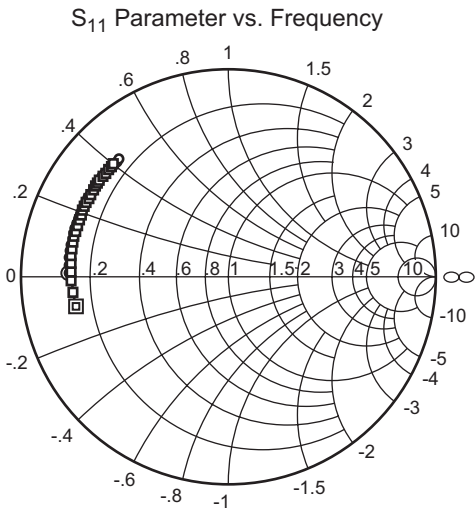

Condition:  $V_{CE} = 3.6\text{ V}$ ,  $Z_0 = 50\ \Omega$   
 400 to 3000 MHz (100 MHz Step)  
 ○ (  $I_C = 100\text{ mA}$  )  
 □ (  $I_C = 250\text{ mA}$  )

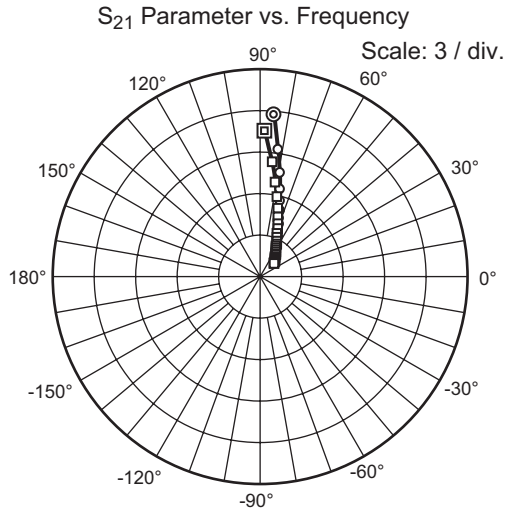

Condition:  $V_{CE} = 3.6\text{ V}$ ,  $Z_0 = 50\ \Omega$   
 400 to 3000 MHz (100 MHz Step)  
 ○ (  $I_C = 100\text{ mA}$  )  
 □ (  $I_C = 250\text{ mA}$  )

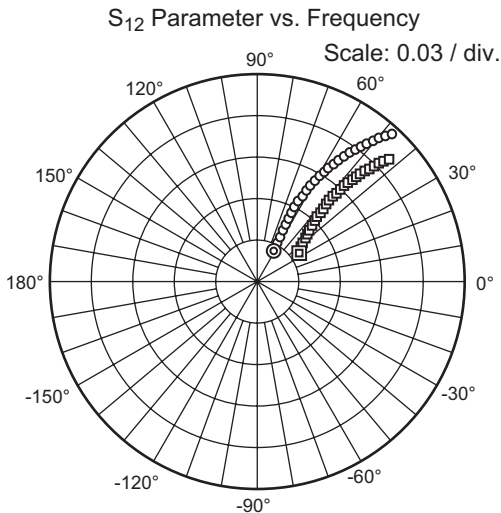

Condition:  $V_{CE} = 3.6\text{ V}$ ,  $Z_0 = 50\ \Omega$   
 400 to 3000 MHz (100 MHz Step)  
 ○ (  $I_C = 100\text{ mA}$  )  
 □ (  $I_C = 250\text{ mA}$  )

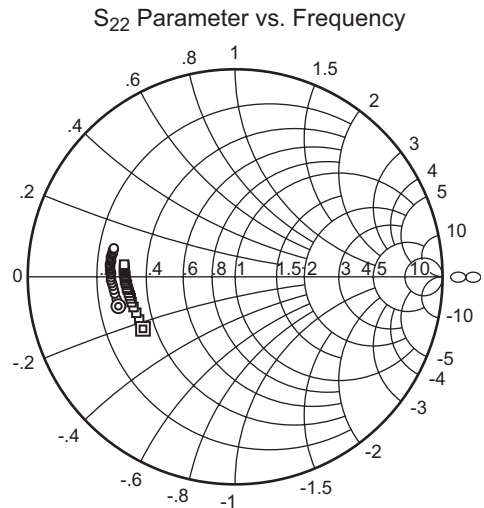

Condition:  $V_{CE} = 3.6\text{ V}$ ,  $Z_0 = 50\ \Omega$   
 400 to 3000 MHz (100 MHz Step)  
 ○ (  $I_C = 100\text{ mA}$  )  
 □ (  $I_C = 250\text{ mA}$  )

## S parameter

(V<sub>CE</sub> = 3 V, I<sub>C</sub> = 10 mA, Z<sub>o</sub> = 50 Ω)

f (MHz)	S11		S21		S12		S22	
	MAG	ANG (deg.)	MAG	ANG (deg.)	MAG	ANG (deg.)	MAG	ANG (deg.)
400	0.748	-149.1	7.99	94.1	0.061	23.0	0.475	-124.4
500	0.751	-158.6	6.48	88.1	0.063	22.1	0.457	-133.2
600	0.755	-165.6	5.42	83.5	0.064	21.5	0.449	-139.7
700	0.758	-170.8	4.63	79.8	0.065	21.8	0.445	-144.6
800	0.760	-175.2	4.02	76.6	0.066	22.1	0.443	-148.6
900	0.762	-178.9	3.55	73.8	0.067	22.7	0.443	-151.8
1000	0.765	177.8	3.17	71.3	0.068	23.5	0.444	-154.5
1100	0.768	174.9	2.87	69.0	0.070	24.6	0.446	-156.8
1200	0.770	172.1	2.62	66.7	0.071	25.5	0.447	-158.7
1300	0.771	169.7	2.41	64.5	0.073	26.1	0.449	-160.4
1400	0.772	167.2	2.23	62.4	0.074	27.2	0.452	-161.8
1500	0.774	164.8	2.07	60.4	0.076	27.9	0.454	-163.1
1600	0.776	162.7	1.94	58.5	0.077	29.0	0.456	-164.2
1700	0.780	160.7	1.82	56.7	0.079	29.7	0.459	-165.2
1800	0.781	158.9	1.71	54.8	0.081	30.3	0.462	-166.1
1900	0.781	157.1	1.62	52.9	0.083	31.1	0.465	-166.9
2000	0.781	155.1	1.54	51.1	0.085	31.6	0.468	-167.6
2100	0.782	153.2	1.47	49.3	0.088	32.1	0.470	-168.3
2200	0.784	151.4	1.40	47.5	0.090	32.7	0.473	-168.9
2300	0.788	149.8	1.34	46.0	0.092	33.1	0.476	-169.5
2400	0.790	148.3	1.28	44.3	0.095	33.4	0.478	-170.1
2500	0.791	146.8	1.23	42.7	0.097	33.8	0.481	-170.6
2600	0.789	145.1	1.18	40.9	0.100	33.9	0.483	-171.1
2700	0.789	143.3	1.14	39.2	0.102	34.2	0.486	-171.7
2800	0.790	141.6	1.10	37.5	0.105	34.4	0.488	-172.2
2900	0.793	140.1	1.07	36.1	0.108	34.4	0.491	-172.7
3000	0.795	138.7	1.03	34.5	0.111	34.3	0.493	-173.3



**S parameter** $(V_{CE} = 3 \text{ V}, I_C = 20 \text{ mA}, Z_o = 50 \Omega)$ 

f (MHz)	S11		S21		S12		S22	
	MAG	ANG (deg.)	MAG	ANG (deg.)	MAG	ANG (deg.)	MAG	ANG (deg.)
400	0.750	-165.7	9.73	89.3	0.042	31.0	0.505	-146.0
500	0.754	-171.7	7.74	84.8	0.044	33.1	0.501	-152.5
600	0.758	-176.3	6.39	81.3	0.046	34.3	0.501	-157.1
700	0.761	180.0	5.43	78.4	0.049	36.2	0.503	-160.6
800	0.762	176.7	4.70	75.8	0.052	37.5	0.504	-163.5
900	0.763	173.8	4.14	73.5	0.055	38.8	0.506	-165.8
1000	0.766	171.2	3.69	71.5	0.058	40.2	0.508	-167.8
1100	0.768	168.8	3.34	69.6	0.061	41.5	0.510	-169.5
1200	0.768	166.5	3.04	67.6	0.064	42.3	0.512	-171.0
1300	0.769	164.4	2.80	65.8	0.067	42.8	0.513	-172.3
1400	0.769	162.2	2.59	64.0	0.071	43.5	0.515	-173.4
1500	0.770	160.1	2.41	62.2	0.074	43.8	0.516	-174.5
1600	0.772	158.2	2.26	60.6	0.078	44.2	0.518	-175.5
1700	0.775	156.5	2.12	58.9	0.081	44.4	0.519	-176.3
1800	0.775	154.9	2.00	57.3	0.084	44.4	0.521	-177.1
1900	0.775	153.2	1.89	55.6	0.087	44.6	0.522	-177.8
2000	0.774	151.4	1.80	53.9	0.091	44.4	0.523	-178.4
2100	0.774	149.6	1.71	52.3	0.095	44.2	0.524	-179.0
2200	0.776	148.0	1.64	50.7	0.098	43.9	0.525	-179.7
2300	0.778	146.4	1.57	49.3	0.101	43.8	0.526	179.7
2400	0.780	145.0	1.50	47.8	0.105	43.4	0.527	179.2
2500	0.780	143.6	1.44	46.3	0.108	43.1	0.527	178.7
2600	0.778	142.0	1.39	44.6	0.112	42.6	0.528	178.1
2700	0.777	140.3	1.34	43.0	0.115	42.3	0.528	177.6
2800	0.777	138.7	1.30	41.4	0.119	41.8	0.529	177.1
2900	0.779	137.3	1.26	40.0	0.123	41.3	0.530	176.5
3000	0.781	136.0	1.22	38.6	0.126	40.7	0.530	176.0

## S parameter

 $(V_{CE} = 3 \text{ V}, I_C = 30 \text{ mA}, Z_o = 50 \Omega)$ 

f (MHz)	S11		S21		S12		S22	
	MAG	ANG (deg.)	MAG	ANG (deg.)	MAG	ANG (deg.)	MAG	ANG (deg.)
400	0.755	-172.0	10.39	87.5	0.035	38.2	0.531	-154.4
500	0.759	-176.8	8.22	83.6	0.038	41.0	0.531	-159.7
600	0.763	179.5	6.78	80.5	0.041	42.9	0.534	-163.4
700	0.764	176.3	5.75	77.9	0.045	45.1	0.536	-166.3
800	0.766	173.4	4.98	75.5	0.048	46.5	0.538	-168.7
900	0.766	170.8	4.39	73.5	0.052	47.5	0.540	-170.7
1000	0.768	168.4	3.91	71.6	0.056	48.7	0.543	-172.4
1100	0.770	166.3	3.54	69.9	0.060	49.6	0.544	-173.9
1200	0.770	164.2	3.22	68.1	0.063	50.1	0.546	-175.2
1300	0.770	162.2	2.97	66.4	0.067	50.2	0.547	-176.4
1400	0.770	160.2	2.75	64.7	0.071	50.4	0.549	-177.5
1500	0.771	158.2	2.56	63.0	0.075	50.3	0.550	-178.5
1600	0.772	156.4	2.39	61.5	0.079	50.4	0.551	-179.4
1700	0.774	154.7	2.25	60.0	0.083	50.3	0.552	179.9
1800	0.775	153.2	2.12	58.4	0.087	49.8	0.554	179.1
1900	0.774	151.5	2.01	56.8	0.090	49.7	0.554	178.4
2000	0.773	149.8	1.91	55.2	0.094	49.3	0.555	177.8
2100	0.773	148.1	1.82	53.6	0.098	48.8	0.555	177.1
2200	0.774	146.5	1.74	52.1	0.102	48.3	0.556	176.5
2300	0.776	145.0	1.67	50.7	0.106	47.8	0.556	175.9
2400	0.777	143.6	1.60	49.3	0.110	47.2	0.556	175.4
2500	0.777	142.2	1.54	47.9	0.114	46.7	0.556	174.8
2600	0.775	140.7	1.48	46.3	0.117	45.9	0.556	174.3
2700	0.774	139.0	1.43	44.7	0.121	45.4	0.556	173.7
2800	0.774	137.4	1.38	43.1	0.125	44.7	0.556	173.1
2900	0.775	136.1	1.34	41.8	0.129	44.0	0.556	172.6
3000	0.776	134.7	1.30	40.4	0.133	43.2	0.556	172.0

## S parameter

(V<sub>CE</sub> = 3 V, I<sub>C</sub> = 50 mA, Z<sub>o</sub> = 50 Ω)

f (MHz)	S11		S21		S12		S22	
	MAG	ANG (deg.)	MAG	ANG (deg.)	MAG	ANG (deg.)	MAG	ANG (deg.)
400	0.762	-177.4	10.93	86.0	0.029	48.2	0.561	-161.3
500	0.765	178.9	8.64	82.6	0.033	51.2	0.564	-165.5
600	0.768	175.9	7.11	79.8	0.037	53.0	0.567	-168.5
700	0.770	173.1	6.03	77.5	0.042	54.7	0.570	-170.9
800	0.770	170.6	5.22	75.4	0.046	55.4	0.573	-172.9
900	0.770	168.3	4.60	73.5	0.050	56.2	0.575	-174.6
1000	0.772	166.1	4.10	71.8	0.055	56.7	0.577	-176.1
1100	0.773	164.1	3.71	70.2	0.059	57.0	0.579	-177.4
1200	0.773	162.2	3.38	68.6	0.063	56.9	0.580	-178.6
1300	0.772	160.3	3.11	67.0	0.068	56.5	0.581	-179.7
1400	0.772	158.4	2.89	65.3	0.072	56.5	0.582	179.4
1500	0.772	156.5	2.69	63.8	0.077	56.1	0.584	178.4
1600	0.774	154.7	2.52	62.3	0.081	55.8	0.585	177.6
1700	0.776	153.1	2.36	60.9	0.085	55.3	0.585	176.8
1800	0.775	151.6	2.23	59.5	0.089	54.5	0.586	176.1
1900	0.775	150.1	2.11	57.9	0.094	54.1	0.586	175.4
2000	0.773	148.4	2.01	56.4	0.098	53.4	0.586	174.8
2100	0.772	146.7	1.92	54.8	0.102	52.6	0.586	174.1
2200	0.773	145.1	1.83	53.4	0.106	52.0	0.586	173.5
2300	0.776	143.7	1.75	52.1	0.110	51.2	0.586	172.9
2400	0.776	142.4	1.68	50.7	0.114	50.4	0.586	172.3
2500	0.776	141.0	1.62	49.3	0.119	49.7	0.586	171.7
2600	0.774	139.4	1.56	47.8	0.122	48.7	0.585	171.2
2700	0.772	137.8	1.51	46.3	0.127	48.0	0.585	170.6
2800	0.772	136.3	1.46	44.8	0.131	47.2	0.584	170.0
2900	0.773	134.9	1.41	43.4	0.135	46.2	0.584	169.4
3000	0.774	133.6	1.37	42.1	0.139	45.3	0.583	168.8

## S parameter

(V<sub>CE</sub> = 3 V, I<sub>C</sub> = 70 mA, Z<sub>o</sub> = 50 Ω)

f (MHz)	S11		S21		S12		S22	
	MAG	ANG (deg.)	MAG	ANG (deg.)	MAG	ANG (deg.)	MAG	ANG (deg.)
400	0.767	-179.7	11.15	85.3	0.027	54.1	0.576	-164.2
500	0.769	177.0	8.80	82.2	0.032	56.7	0.580	-167.9
600	0.772	174.3	7.24	79.6	0.036	58.8	0.584	-170.7
700	0.773	171.7	6.14	77.4	0.041	59.5	0.587	-172.8
800	0.773	169.3	5.32	75.4	0.045	59.9	0.589	-174.7
900	0.773	167.1	4.69	73.6	0.050	60.1	0.591	-176.3
1000	0.774	165.0	4.18	72.0	0.055	60.4	0.594	-177.7
1100	0.775	163.1	3.78	70.4	0.060	60.7	0.595	-178.9
1200	0.775	161.3	3.45	68.8	0.064	60.1	0.597	180.0
1300	0.774	159.4	3.18	67.3	0.069	59.5	0.597	179.0
1400	0.774	157.6	2.95	65.7	0.073	59.2	0.599	178.0
1500	0.774	155.7	2.74	64.2	0.078	58.6	0.600	177.1
1600	0.775	154.0	2.57	62.8	0.082	58.0	0.600	176.3
1700	0.777	152.4	2.42	61.4	0.087	57.4	0.601	175.6
1800	0.776	150.9	2.28	60.0	0.091	56.7	0.601	174.9
1900	0.776	149.4	2.16	58.5	0.095	56.0	0.602	174.2
2000	0.773	147.7	2.05	57.0	0.099	55.2	0.602	173.5
2100	0.773	146.1	1.96	55.5	0.104	54.4	0.601	172.9
2200	0.774	144.5	1.87	54.1	0.108	53.6	0.601	172.2
2300	0.776	143.1	1.79	52.8	0.112	52.8	0.601	171.6
2400	0.776	141.8	1.72	51.4	0.117	51.9	0.601	171.1
2500	0.776	140.4	1.66	50.1	0.121	51.0	0.600	170.5
2600	0.773	138.9	1.60	48.5	0.125	50.0	0.599	169.9
2700	0.772	137.3	1.54	47.0	0.129	49.2	0.599	169.3
2800	0.771	135.7	1.49	45.5	0.133	48.2	0.598	168.7
2900	0.773	134.4	1.45	44.2	0.138	47.4	0.597	168.1
3000	0.773	133.1	1.40	42.9	0.142	46.3	0.597	167.5

## S parameter

 $(V_{CE} = 3 \text{ V}, I_C = 100 \text{ mA}, Z_o = 50 \Omega)$ 

f (MHz)	S11		S21		S12		S22	
	MAG	ANG (deg.)	MAG	ANG (deg.)	MAG	ANG (deg.)	MAG	ANG (deg.)
400	0.771	178.5	11.27	84.9	0.026	59.9	0.588	-166.4
500	0.773	175.5	8.90	81.9	0.031	62.2	0.592	-169.7
600	0.775	173.0	7.32	79.4	0.035	63.0	0.596	-172.2
700	0.776	170.6	6.21	77.3	0.040	63.2	0.599	-174.2
800	0.776	168.3	5.38	75.4	0.045	63.7	0.602	-176.0
900	0.776	166.2	4.74	73.7	0.050	63.4	0.604	-177.5
1000	0.776	164.2	4.23	72.1	0.055	63.3	0.606	-178.8
1100	0.777	162.4	3.83	70.6	0.060	63.1	0.608	-180.0
1200	0.777	160.6	3.49	69.1	0.064	62.4	0.609	178.9
1300	0.776	158.8	3.22	67.6	0.069	62.0	0.610	178.0
1400	0.776	156.9	2.99	66.0	0.074	61.3	0.611	177.0
1500	0.776	155.1	2.78	64.5	0.078	60.7	0.612	176.2
1600	0.777	153.4	2.60	63.2	0.083	60.0	0.612	175.4
1700	0.779	151.8	2.45	61.8	0.088	59.2	0.613	174.7
1800	0.778	150.4	2.31	60.4	0.092	58.3	0.613	173.9
1900	0.777	148.9	2.19	58.9	0.096	57.6	0.613	173.2
2000	0.775	147.2	2.08	57.4	0.101	56.6	0.613	172.6
2100	0.775	145.6	1.99	56.0	0.105	55.7	0.613	172.0
2200	0.775	144.0	1.90	54.6	0.110	54.9	0.613	171.3
2300	0.777	142.6	1.82	53.3	0.114	53.9	0.612	170.7
2400	0.778	141.3	1.75	52.0	0.118	53.0	0.612	170.1
2500	0.777	139.9	1.68	50.6	0.123	52.1	0.611	169.6
2600	0.774	138.4	1.62	49.1	0.127	51.1	0.610	168.9
2700	0.773	136.8	1.57	47.6	0.131	50.1	0.610	168.3
2800	0.772	135.3	1.51	46.1	0.135	49.3	0.609	167.7
2900	0.773	133.9	1.47	44.9	0.140	48.2	0.608	167.1
3000	0.774	132.6	1.43	43.5	0.144	47.1	0.607	166.5

## S parameter

(V<sub>CE</sub> = 3 V, I<sub>C</sub> = 150 mA, Z<sub>o</sub> = 50 Ω)

f (MHz)	S11		S21		S12		S22	
	MAG	ANG (deg.)	MAG	ANG (deg.)	MAG	ANG (deg.)	MAG	ANG (deg.)
400	0.776	177.0	11.25	84.6	0.025	64.8	0.597	-168.1
500	0.777	174.3	8.88	81.7	0.030	65.7	0.602	-171.1
600	0.780	172.0	7.30	79.4	0.035	66.7	0.606	-173.4
700	0.780	169.7	6.20	77.3	0.040	66.5	0.609	-175.3
800	0.780	167.5	5.38	75.5	0.045	66.3	0.611	-177.0
900	0.779	165.5	4.74	73.8	0.050	66.1	0.613	-178.4
1000	0.780	163.5	4.23	72.3	0.055	65.8	0.615	-179.7
1100	0.781	161.8	3.83	70.9	0.060	65.3	0.617	179.2
1200	0.781	160.0	3.50	69.3	0.065	64.4	0.618	178.1
1300	0.780	158.2	3.22	67.9	0.069	63.7	0.619	177.2
1400	0.779	156.4	2.99	66.3	0.074	63.0	0.620	176.3
1500	0.779	154.6	2.79	64.9	0.079	62.2	0.620	175.4
1600	0.780	152.9	2.61	63.5	0.084	61.6	0.621	174.7
1700	0.782	151.4	2.46	62.2	0.088	60.6	0.622	173.9
1800	0.781	150.0	2.32	60.7	0.093	59.6	0.622	173.2
1900	0.780	148.4	2.20	59.3	0.097	58.9	0.621	172.5
2000	0.778	146.8	2.09	57.8	0.102	57.9	0.621	171.9
2100	0.778	145.2	1.99	56.3	0.106	56.9	0.621	171.3
2200	0.778	143.6	1.91	54.9	0.111	56.0	0.621	170.6
2300	0.780	142.2	1.83	53.7	0.115	55.0	0.620	170.0
2400	0.780	140.9	1.76	52.4	0.119	54.0	0.620	169.4
2500	0.780	139.6	1.69	51.0	0.124	53.1	0.619	168.8
2600	0.777	138.0	1.63	49.5	0.128	52.0	0.618	168.2
2700	0.776	136.4	1.57	48.0	0.132	51.1	0.618	167.6
2800	0.775	134.9	1.52	46.6	0.137	50.0	0.617	167.0
2900	0.776	133.6	1.48	45.3	0.141	49.0	0.616	166.4
3000	0.777	132.3	1.43	44.0	0.145	47.8	0.615	165.8

## S parameter

(V<sub>CE</sub> = 3 V, I<sub>C</sub> = 200 mA, Z<sub>o</sub> = 50 Ω)

f (MHz)	S11		S21		S12		S22	
	MAG	ANG (deg.)	MAG	ANG (deg.)	MAG	ANG (deg.)	MAG	ANG (deg.)
400	0.781	176.2	11.06	84.5	0.025	67.5	0.602	-168.9
500	0.782	173.7	8.73	81.7	0.030	68.0	0.606	-171.9
600	0.784	171.4	7.18	79.4	0.035	68.4	0.610	-174.1
700	0.785	169.3	6.10	77.4	0.040	68.4	0.613	-175.9
800	0.785	167.1	5.29	75.6	0.045	67.7	0.615	-177.6
900	0.784	165.1	4.67	74.0	0.050	67.2	0.618	-178.9
1000	0.785	163.2	4.17	72.5	0.055	66.7	0.619	179.8
1100	0.786	161.4	3.78	71.0	0.060	66.4	0.620	178.7
1200	0.785	159.7	3.45	69.5	0.065	65.6	0.621	177.7
1300	0.784	157.9	3.18	68.0	0.070	64.7	0.622	176.8
1400	0.784	156.1	2.95	66.5	0.074	64.0	0.623	175.9
1500	0.783	154.3	2.75	65.0	0.079	63.0	0.623	175.0
1600	0.784	152.6	2.58	63.7	0.084	62.2	0.624	174.3
1700	0.786	151.2	2.43	62.3	0.089	61.3	0.625	173.6
1800	0.786	149.7	2.29	60.9	0.093	60.3	0.625	172.8
1900	0.784	148.2	2.17	59.4	0.098	59.4	0.625	172.2
2000	0.782	146.6	2.06	58.0	0.102	58.5	0.624	171.6
2100	0.782	145.0	1.97	56.5	0.107	57.5	0.624	171.0
2200	0.782	143.4	1.89	55.1	0.111	56.5	0.624	170.3
2300	0.784	142.0	1.81	53.8	0.116	55.5	0.624	169.7
2400	0.785	140.7	1.74	52.5	0.120	54.5	0.623	169.1
2500	0.784	139.4	1.67	51.1	0.124	53.6	0.622	168.5
2600	0.781	137.8	1.61	49.6	0.129	52.4	0.621	167.9
2700	0.780	136.3	1.56	48.1	0.133	51.5	0.621	167.3
2800	0.779	134.7	1.51	46.7	0.138	50.5	0.620	166.7
2900	0.780	133.4	1.46	45.4	0.142	49.4	0.619	166.0
3000	0.780	132.1	1.42	44.1	0.146	48.3	0.618	165.4

## S parameter

(V<sub>CE</sub> = 3 V, I<sub>C</sub> = 250 mA, Z<sub>o</sub> = 50 Ω)

f (MHz)	S11		S21		S12		S22	
	MAG	ANG (deg.)	MAG	ANG (deg.)	MAG	ANG (deg.)	MAG	ANG (deg.)
400	0.752	-169.6	10.13	88.1	0.037	35.1	0.519	-151.2
500	0.757	-174.8	8.03	84.0	0.040	37.3	0.518	-156.9
600	0.761	-178.8	6.62	80.7	0.043	39.4	0.520	-161.0
700	0.763	177.8	5.62	78.0	0.046	41.4	0.522	-164.2
800	0.764	174.7	4.87	75.5	0.050	42.8	0.524	-166.7
900	0.765	172.0	4.29	73.4	0.053	44.0	0.526	-168.9
1000	0.767	169.5	3.83	71.4	0.057	45.4	0.528	-170.7
1100	0.768	167.3	3.46	69.6	0.060	46.3	0.530	-172.3
1200	0.769	165.2	3.15	67.8	0.064	46.7	0.531	-173.6
1300	0.769	163.1	2.90	66.0	0.067	47.1	0.533	-174.9
1400	0.770	161.0	2.69	64.3	0.071	47.6	0.535	-176.0
1500	0.770	159.0	2.50	62.6	0.074	47.7	0.536	-177.0
1600	0.772	157.1	2.34	61.0	0.078	47.9	0.537	-177.9
1700	0.774	155.4	2.20	59.4	0.082	48.0	0.539	-178.7
1800	0.775	153.8	2.07	57.8	0.086	47.7	0.540	-179.4
1900	0.774	152.2	1.96	56.2	0.089	47.6	0.540	179.8
2000	0.772	150.5	1.86	54.6	0.093	47.3	0.541	179.2
2100	0.773	148.7	1.78	53.0	0.097	47.0	0.542	178.6
2200	0.774	147.1	1.70	51.4	0.100	46.6	0.543	177.9
2300	0.777	145.6	1.63	50.0	0.104	46.2	0.543	177.3
2400	0.778	144.2	1.56	48.6	0.108	45.7	0.543	176.8
2500	0.778	142.8	1.50	47.1	0.111	45.3	0.544	176.3
2600	0.776	141.2	1.44	45.5	0.115	44.7	0.544	175.7
2700	0.775	139.6	1.39	43.9	0.119	44.2	0.544	175.1
2800	0.775	137.9	1.35	42.3	0.122	43.6	0.544	174.6
2900	0.776	136.6	1.31	40.9	0.126	42.9	0.544	174.1
3000	0.778	135.2	1.27	39.5	0.130	42.2	0.545	173.5



## S parameter

 $(V_{CE} = 3.3 \text{ V}, I_C = 10 \text{ mA}, Z_o = 50 \Omega)$ 

f (MHz)	S11		S21		S12		S22	
	MAG	ANG (deg.)	MAG	ANG (deg.)	MAG	ANG (deg.)	MAG	ANG (deg.)
400	0.748	-148.7	8.07	94.2	0.061	23.5	0.473	-123.3
500	0.751	-158.3	6.56	88.2	0.062	22.2	0.454	-132.2
600	0.755	-165.3	5.49	83.5	0.063	21.8	0.445	-138.7
700	0.757	-170.6	4.69	79.8	0.065	22.0	0.441	-143.8
800	0.760	-175.0	4.07	76.5	0.066	22.2	0.439	-147.7
900	0.761	-178.7	3.59	73.8	0.067	22.7	0.439	-151.1
1000	0.764	178.0	3.21	71.2	0.068	23.7	0.440	-153.8
1100	0.767	175.0	2.90	68.9	0.069	24.8	0.441	-156.1
1200	0.769	172.3	2.65	66.7	0.071	25.6	0.443	-158.1
1300	0.770	169.8	2.43	64.4	0.072	26.3	0.445	-159.7
1400	0.771	167.3	2.25	62.4	0.074	27.3	0.448	-161.2
1500	0.772	164.9	2.10	60.3	0.075	28.2	0.450	-162.5
1600	0.775	162.8	1.96	58.5	0.077	29.2	0.452	-163.6
1700	0.779	160.8	1.84	56.6	0.079	29.9	0.456	-164.6
1800	0.780	159.0	1.73	54.7	0.081	30.5	0.458	-165.5
1900	0.780	157.1	1.64	52.9	0.083	31.3	0.461	-166.3
2000	0.779	155.2	1.55	51.0	0.085	31.8	0.464	-167.0
2100	0.781	153.3	1.48	49.2	0.087	32.4	0.466	-167.7
2200	0.783	151.5	1.41	47.5	0.090	32.8	0.469	-168.4
2300	0.787	149.8	1.35	45.9	0.092	33.3	0.472	-169.0
2400	0.788	148.3	1.29	44.3	0.094	33.6	0.474	-169.6
2500	0.790	146.8	1.24	42.6	0.097	34.0	0.477	-170.1
2600	0.788	145.1	1.20	40.8	0.099	34.1	0.480	-170.6
2700	0.788	143.3	1.15	39.1	0.102	34.3	0.482	-171.2
2800	0.789	141.6	1.11	37.4	0.105	34.6	0.485	-171.7
2900	0.791	140.1	1.08	36.0	0.107	34.6	0.487	-172.3
3000	0.794	138.7	1.04	34.5	0.110	34.6	0.490	-172.8

## S parameter

 $(V_{CE} = 3.3 \text{ V}, I_C = 20 \text{ mA}, Z_o = 50 \Omega)$ 

f (MHz)	S11		S21		S12		S22	
	MAG	ANG (deg.)	MAG	ANG (deg.)	MAG	ANG (deg.)	MAG	ANG (deg.)
400	0.748	-165.5	9.86	89.3	0.041	31.3	0.500	-145.4
500	0.752	-171.6	7.85	84.8	0.044	33.0	0.496	-151.9
600	0.757	-176.1	6.48	81.3	0.046	34.4	0.496	-156.6
700	0.759	-179.9	5.50	78.3	0.049	36.3	0.497	-160.1
800	0.761	176.8	4.77	75.7	0.052	37.7	0.499	-163.0
900	0.762	173.9	4.20	73.4	0.054	39.0	0.501	-165.4
1000	0.764	171.2	3.75	71.4	0.058	40.3	0.503	-167.4
1100	0.766	168.9	3.38	69.5	0.061	41.6	0.505	-169.1
1200	0.767	166.6	3.08	67.6	0.064	42.4	0.507	-170.6
1300	0.767	164.5	2.84	65.7	0.067	42.8	0.508	-171.9
1400	0.768	162.3	2.63	63.9	0.070	43.6	0.510	-173.1
1500	0.768	160.2	2.44	62.1	0.074	43.9	0.512	-174.2
1600	0.770	158.3	2.29	60.5	0.077	44.4	0.513	-175.1
1700	0.773	156.5	2.15	58.8	0.081	44.6	0.515	-175.9
1800	0.774	154.9	2.02	57.2	0.084	44.5	0.516	-176.7
1900	0.773	153.2	1.91	55.5	0.087	44.6	0.517	-177.5
2000	0.772	151.5	1.82	53.9	0.091	44.5	0.518	-178.1
2100	0.773	149.7	1.73	52.2	0.094	44.3	0.520	-178.7
2200	0.774	148.0	1.66	50.6	0.098	44.2	0.521	-179.4
2300	0.777	146.5	1.59	49.2	0.101	43.9	0.522	-179.9
2400	0.778	145.1	1.52	47.7	0.104	43.6	0.522	179.5
2500	0.779	143.7	1.46	46.2	0.108	43.3	0.523	179.0
2600	0.776	142.0	1.41	44.5	0.111	42.8	0.524	178.5
2700	0.776	140.4	1.36	42.9	0.115	42.4	0.524	177.9
2800	0.776	138.8	1.31	41.3	0.118	41.9	0.525	177.4
2900	0.778	137.4	1.27	39.9	0.122	41.4	0.525	176.9
3000	0.779	136.0	1.23	38.5	0.125	40.8	0.526	176.3

## S parameter

(V<sub>CE</sub> = 3.3 V, I<sub>C</sub> = 30 mA, Z<sub>o</sub> = 50 Ω)

f (MHz)	S11		S21		S12		S22	
	MAG	ANG (deg.)	MAG	ANG (deg.)	MAG	ANG (deg.)	MAG	ANG (deg.)
400	0.753	-171.8	10.53	87.5	0.034	38.6	0.525	-153.8
500	0.757	-176.5	8.34	83.6	0.038	40.8	0.526	-159.1
600	0.761	179.7	6.87	80.5	0.041	43.4	0.528	-162.9
700	0.763	176.4	5.83	77.8	0.044	45.1	0.530	-165.9
800	0.764	173.6	5.05	75.5	0.048	46.5	0.532	-168.3
900	0.765	170.9	4.44	73.4	0.052	47.5	0.535	-170.4
1000	0.766	168.5	3.97	71.5	0.056	48.8	0.537	-172.1
1100	0.768	166.4	3.58	69.8	0.059	49.5	0.539	-173.5
1200	0.768	164.3	3.27	68.0	0.063	49.8	0.541	-174.9
1300	0.768	162.3	3.00	66.3	0.067	50.1	0.542	-176.0
1400	0.768	160.3	2.78	64.6	0.071	50.4	0.543	-177.1
1500	0.768	158.3	2.59	62.9	0.075	50.4	0.545	-178.1
1600	0.770	156.5	2.42	61.4	0.079	50.4	0.546	-179.0
1700	0.773	154.8	2.28	59.8	0.083	50.2	0.547	-179.8
1800	0.773	153.2	2.15	58.3	0.086	50.0	0.548	179.4
1900	0.772	151.6	2.03	56.7	0.090	49.7	0.549	178.7
2000	0.770	149.9	1.93	55.1	0.094	49.3	0.549	178.1
2100	0.771	148.2	1.84	53.5	0.098	48.9	0.550	177.5
2200	0.772	146.5	1.76	52.0	0.102	48.4	0.551	176.8
2300	0.775	145.0	1.69	50.6	0.105	47.9	0.551	176.2
2400	0.775	143.7	1.62	49.2	0.109	47.3	0.551	175.7
2500	0.776	142.3	1.55	47.7	0.113	46.8	0.551	175.1
2600	0.773	140.7	1.50	46.2	0.117	46.0	0.551	174.6
2700	0.772	139.1	1.44	44.6	0.121	45.5	0.551	174.0
2800	0.772	137.5	1.40	43.0	0.124	44.7	0.551	173.5
2900	0.773	136.1	1.35	41.7	0.128	44.1	0.551	172.9
3000	0.775	134.8	1.31	40.3	0.132	43.2	0.551	172.3

## S parameter

(V<sub>CE</sub> = 3.3 V, I<sub>C</sub> = 50 mA, Z<sub>o</sub> = 50 Ω)

f (MHz)	S11		S21		S12		S22	
	MAG	ANG (deg.)	MAG	ANG (deg.)	MAG	ANG (deg.)	MAG	ANG (deg.)
400	0.760	-177.2	11.09	86.0	0.029	48.6	0.554	-160.8
500	0.763	179.1	8.76	82.6	0.033	51.5	0.557	-165.1
600	0.766	176.0	7.21	79.8	0.037	53.2	0.561	-168.1
700	0.767	173.3	6.11	77.4	0.042	54.6	0.564	-170.5
800	0.768	170.7	5.30	75.3	0.046	55.5	0.567	-172.6
900	0.768	168.3	4.66	73.4	0.050	56.0	0.569	-174.3
1000	0.770	166.2	4.16	71.7	0.055	56.7	0.571	-175.8
1100	0.771	164.2	3.76	70.1	0.059	57.1	0.573	-177.1
1200	0.771	162.3	3.43	68.5	0.063	56.8	0.575	-178.3
1300	0.770	160.4	3.16	66.9	0.068	56.6	0.576	-179.4
1400	0.770	158.4	2.93	65.2	0.072	56.6	0.577	179.6
1500	0.770	156.5	2.72	63.7	0.076	56.1	0.578	178.7
1600	0.771	154.8	2.55	62.3	0.081	55.8	0.579	177.9
1700	0.774	153.2	2.40	60.8	0.085	55.3	0.580	177.1
1800	0.773	151.7	2.26	59.3	0.089	54.6	0.581	176.4
1900	0.772	150.1	2.14	57.8	0.093	54.1	0.581	175.6
2000	0.770	148.5	2.03	56.3	0.097	53.4	0.581	175.0
2100	0.771	146.8	1.94	54.8	0.102	52.7	0.581	174.4
2200	0.771	145.2	1.85	53.3	0.106	51.9	0.581	173.7
2300	0.774	143.7	1.78	52.0	0.110	51.3	0.581	173.1
2400	0.774	142.4	1.70	50.7	0.114	50.5	0.581	172.6
2500	0.774	141.1	1.64	49.2	0.118	49.7	0.581	172.0
2600	0.771	139.5	1.58	47.7	0.122	48.8	0.580	171.4
2700	0.770	137.9	1.52	46.2	0.126	48.1	0.580	170.8
2800	0.770	136.3	1.47	44.7	0.130	47.2	0.579	170.2
2900	0.771	135.0	1.43	43.3	0.134	46.3	0.579	169.7
3000	0.772	133.7	1.39	42.0	0.138	45.4	0.578	169.1

## S parameter

(V<sub>CE</sub> = 3.3 V, I<sub>C</sub> = 70 mA, Z<sub>o</sub> = 50 Ω)

f (MHz)	S11		S21		S12		S22	
	MAG	ANG (deg.)	MAG	ANG (deg.)	MAG	ANG (deg.)	MAG	ANG (deg.)
400	0.764	-179.6	11.32	85.4	0.027	54.3	0.570	-163.9
500	0.767	177.1	8.94	82.2	0.031	57.0	0.574	-167.6
600	0.769	174.4	7.35	79.6	0.036	58.7	0.578	-170.3
700	0.770	171.8	6.23	77.3	0.041	59.5	0.581	-172.5
800	0.771	169.4	5.40	75.3	0.045	60.0	0.583	-174.4
900	0.771	167.2	4.75	73.5	0.050	60.5	0.586	-176.0
1000	0.772	165.1	4.25	71.9	0.055	60.4	0.588	-177.4
1100	0.773	163.2	3.84	70.3	0.059	60.6	0.590	-178.6
1200	0.773	161.3	3.50	68.8	0.064	60.2	0.591	-179.8
1300	0.772	159.5	3.22	67.2	0.068	59.5	0.592	179.2
1400	0.772	157.6	2.99	65.6	0.073	59.3	0.594	178.2
1500	0.771	155.7	2.78	64.1	0.077	58.6	0.594	177.3
1600	0.773	154.0	2.60	62.8	0.082	58.2	0.595	176.5
1700	0.775	152.4	2.45	61.3	0.086	57.4	0.596	175.8
1800	0.775	151.0	2.31	59.9	0.090	56.7	0.596	175.1
1900	0.773	149.4	2.19	58.4	0.095	56.1	0.596	174.3
2000	0.771	147.8	2.08	56.9	0.099	55.3	0.596	173.8
2100	0.771	146.1	1.98	55.4	0.103	54.4	0.596	173.1
2200	0.772	144.5	1.90	54.0	0.108	53.6	0.597	172.5
2300	0.774	143.1	1.82	52.7	0.112	52.8	0.596	171.8
2400	0.774	141.8	1.74	51.4	0.116	52.0	0.596	171.3
2500	0.774	140.5	1.68	50.0	0.120	51.2	0.595	170.7
2600	0.771	138.9	1.62	48.4	0.124	50.2	0.594	170.1
2700	0.770	137.3	1.56	46.9	0.129	49.3	0.594	169.5
2800	0.770	135.7	1.51	45.5	0.133	48.4	0.593	168.9
2900	0.770	134.4	1.46	44.2	0.137	47.5	0.592	168.3
3000	0.772	133.1	1.42	42.8	0.141	46.3	0.592	167.7

## S parameter

(V<sub>CE</sub> = 3.3 V, I<sub>C</sub> = 100 mA, Z<sub>o</sub> = 50 Ω)

f (MHz)	S11		S21		S12		S22	
	MAG	ANG (deg.)	MAG	ANG (deg.)	MAG	ANG (deg.)	MAG	ANG (deg.)
400	0.768	178.6	11.44	84.9	0.026	60.2	0.582	-166.1
500	0.770	175.7	9.03	81.9	0.031	61.7	0.587	-169.5
600	0.773	173.1	7.43	79.4	0.035	62.5	0.591	-172.0
700	0.773	170.7	6.30	77.3	0.040	63.4	0.594	-174.0
800	0.773	168.4	5.46	75.4	0.045	63.7	0.596	-175.8
900	0.774	166.3	4.81	73.6	0.050	63.2	0.599	-177.3
1000	0.774	164.2	4.30	72.0	0.055	63.2	0.601	-178.6
1100	0.775	162.4	3.88	70.6	0.059	63.0	0.602	-179.8
1200	0.775	160.6	3.54	69.0	0.064	62.4	0.604	179.1
1300	0.774	158.8	3.26	67.5	0.069	61.8	0.605	178.1
1400	0.774	156.9	3.03	66.0	0.074	61.4	0.606	177.2
1500	0.773	155.1	2.82	64.5	0.078	60.7	0.606	176.4
1600	0.775	153.5	2.64	63.2	0.083	60.1	0.607	175.6
1700	0.777	151.9	2.48	61.7	0.087	59.1	0.608	174.8
1800	0.776	150.4	2.34	60.3	0.092	58.2	0.609	174.1
1900	0.775	148.9	2.22	58.9	0.096	57.6	0.608	173.4
2000	0.772	147.3	2.11	57.4	0.100	56.7	0.608	172.8
2100	0.773	145.6	2.01	55.9	0.105	55.8	0.608	172.2
2200	0.773	144.0	1.92	54.5	0.109	54.9	0.608	171.5
2300	0.775	142.6	1.84	53.3	0.113	54.0	0.608	170.9
2400	0.775	141.3	1.77	51.9	0.118	53.0	0.607	170.3
2500	0.776	140.0	1.70	50.6	0.122	52.2	0.607	169.7
2600	0.773	138.4	1.64	49.0	0.126	51.2	0.606	169.1
2700	0.771	136.8	1.59	47.5	0.131	50.3	0.605	168.5
2800	0.771	135.3	1.53	46.1	0.135	49.3	0.604	167.9
2900	0.771	134.0	1.49	44.8	0.139	48.3	0.604	167.3
3000	0.772	132.7	1.44	43.5	0.143	47.2	0.603	166.7

## S parameter

(V<sub>CE</sub> = 3.3 V, I<sub>C</sub> = 150 mA, Z<sub>o</sub> = 50 Ω)

f (MHz)	S11		S21		S12		S22	
	MAG	ANG (deg.)	MAG	ANG (deg.)	MAG	ANG (deg.)	MAG	ANG (deg.)
400	0.773	177.1	11.42	84.6	0.025	64.5	0.593	-167.8
500	0.775	174.4	9.01	81.7	0.030	65.7	0.598	-170.9
600	0.777	172.1	7.41	79.4	0.035	66.5	0.602	-173.2
700	0.778	169.8	6.29	77.3	0.040	66.5	0.605	-175.2
800	0.777	167.6	5.45	75.5	0.045	66.2	0.607	-176.8
900	0.777	165.5	4.81	73.8	0.050	66.2	0.609	-178.3
1000	0.778	163.6	4.30	72.3	0.055	65.7	0.611	-179.6
1100	0.779	161.8	3.89	70.8	0.060	65.3	0.612	179.3
1200	0.779	160.0	3.55	69.3	0.065	64.6	0.613	178.3
1300	0.777	158.3	3.27	67.8	0.069	63.8	0.614	177.3
1400	0.777	156.4	3.03	66.3	0.074	63.1	0.615	176.4
1500	0.776	154.6	2.83	64.8	0.079	62.2	0.616	175.5
1600	0.778	153.0	2.65	63.5	0.084	61.4	0.616	174.8
1700	0.780	151.4	2.49	62.1	0.088	60.5	0.618	174.1
1800	0.779	150.0	2.35	60.7	0.093	59.6	0.618	173.3
1900	0.778	148.4	2.23	59.3	0.097	58.9	0.617	172.6
2000	0.775	146.9	2.12	57.8	0.101	57.9	0.617	172.1
2100	0.776	145.2	2.02	56.4	0.106	56.9	0.617	171.5
2200	0.776	143.6	1.93	54.9	0.110	55.9	0.617	170.8
2300	0.778	142.2	1.85	53.7	0.115	55.0	0.616	170.1
2400	0.778	140.9	1.78	52.4	0.119	54.1	0.615	169.6
2500	0.778	139.6	1.71	51.0	0.124	53.1	0.615	169.0
2600	0.775	138.0	1.65	49.5	0.128	52.0	0.614	168.4
2700	0.774	136.5	1.59	48.0	0.132	51.0	0.614	167.8
2800	0.773	134.9	1.54	46.5	0.136	50.0	0.613	167.1
2900	0.774	133.6	1.50	45.3	0.141	49.1	0.612	166.5
3000	0.775	132.3	1.45	44.0	0.145	47.9	0.611	165.9

## S parameter

(V<sub>CE</sub> = 3.3 V, I<sub>C</sub> = 200 mA, Z<sub>o</sub> = 50 Ω)

f (MHz)	S11		S21		S12		S22	
	MAG	ANG (deg.)	MAG	ANG (deg.)	MAG	ANG (deg.)	MAG	ANG (deg.)
400	0.778	176.3	11.25	84.5	0.025	66.8	0.598	-168.7
500	0.780	173.8	8.87	81.7	0.030	68.3	0.603	-171.7
600	0.782	171.5	7.30	79.4	0.035	68.4	0.606	-173.9
700	0.782	169.3	6.20	77.4	0.040	68.2	0.609	-175.8
800	0.782	167.2	5.38	75.6	0.045	67.8	0.611	-177.4
900	0.782	165.1	4.74	74.0	0.050	67.4	0.614	-178.8
1000	0.782	163.2	4.24	72.5	0.055	66.9	0.615	179.9
1100	0.783	161.5	3.84	71.0	0.060	66.5	0.616	178.8
1200	0.783	159.7	3.50	69.5	0.065	65.5	0.617	177.8
1300	0.782	158.0	3.23	68.0	0.070	64.5	0.618	176.9
1400	0.781	156.1	3.00	66.5	0.075	63.9	0.619	175.9
1500	0.780	154.3	2.79	65.0	0.079	63.1	0.619	175.1
1600	0.782	152.7	2.62	63.7	0.084	62.3	0.620	174.5
1700	0.784	151.2	2.47	62.3	0.089	61.4	0.622	173.7
1800	0.783	149.7	2.32	60.9	0.093	60.3	0.621	172.9
1900	0.782	148.2	2.20	59.4	0.097	59.6	0.621	172.2
2000	0.779	146.6	2.10	58.0	0.102	58.5	0.620	171.7
2100	0.779	145.0	2.00	56.5	0.107	57.5	0.621	171.1
2200	0.780	143.4	1.92	55.1	0.111	56.5	0.620	170.4
2300	0.782	142.0	1.84	53.8	0.115	55.6	0.620	169.8
2400	0.782	140.7	1.76	52.5	0.120	54.6	0.619	169.2
2500	0.782	139.4	1.70	51.2	0.125	53.6	0.619	168.6
2600	0.779	137.8	1.64	49.6	0.129	52.5	0.618	168.0
2700	0.777	136.3	1.58	48.2	0.133	51.6	0.617	167.4
2800	0.777	134.7	1.53	46.7	0.137	50.5	0.616	166.8
2900	0.778	133.4	1.48	45.4	0.142	49.5	0.615	166.2
3000	0.779	132.1	1.44	44.1	0.146	48.4	0.615	165.5



## S parameter

(V<sub>CE</sub> = 3.3 V, I<sub>C</sub> = 250 mA, Z<sub>o</sub> = 50 Ω)

f (MHz)	S11		S21		S12		S22	
	MAG	ANG (deg.)	MAG	ANG (deg.)	MAG	ANG (deg.)	MAG	ANG (deg.)
400	0.750	-169.3	10.27	88.2	0.037	35.1	0.513	-150.5
500	0.755	-174.5	8.14	84.1	0.040	37.2	0.513	-156.2
600	0.759	-178.6	6.71	80.8	0.043	39.2	0.514	-160.4
700	0.761	177.9	5.70	78.0	0.046	41.4	0.516	-163.6
800	0.762	174.9	4.94	75.6	0.049	42.9	0.518	-166.2
900	0.763	172.1	4.34	73.4	0.053	44.0	0.520	-168.4
1000	0.765	169.6	3.88	71.4	0.056	45.3	0.522	-170.2
1100	0.767	167.4	3.50	69.6	0.060	46.3	0.524	-171.8
1200	0.767	165.3	3.19	67.8	0.063	46.8	0.526	-173.2
1300	0.768	163.2	2.94	66.0	0.067	47.2	0.528	-174.4
1400	0.768	161.1	2.72	64.3	0.071	47.5	0.529	-175.6
1500	0.768	159.1	2.53	62.6	0.074	47.8	0.531	-176.6
1600	0.770	157.2	2.37	61.0	0.078	48.0	0.532	-177.5
1700	0.773	155.5	2.22	59.4	0.082	48.0	0.534	-178.3
1800	0.773	153.9	2.10	57.8	0.085	47.8	0.535	-179.1
1900	0.772	152.2	1.98	56.2	0.089	47.6	0.536	-179.8
2000	0.771	150.5	1.88	54.6	0.093	47.4	0.536	179.6
2100	0.772	148.8	1.80	53.0	0.096	47.1	0.537	179.0
2200	0.773	147.2	1.72	51.4	0.100	46.7	0.538	178.3
2300	0.776	145.6	1.64	50.0	0.104	46.2	0.538	177.7
2400	0.776	144.3	1.58	48.6	0.107	45.8	0.538	177.2
2500	0.776	142.9	1.52	47.1	0.111	45.3	0.539	176.7
2600	0.775	141.3	1.46	45.5	0.114	44.8	0.539	176.1
2700	0.774	139.6	1.41	43.9	0.118	44.2	0.539	175.6
2800	0.773	138.0	1.36	42.3	0.122	43.6	0.540	175.0
2900	0.775	136.6	1.32	40.9	0.126	43.1	0.540	174.5
3000	0.777	135.3	1.28	39.6	0.129	42.2	0.540	173.9

## S parameter

(V<sub>CE</sub> = 3.6 V, I<sub>C</sub> = 10 mA, Z<sub>o</sub> = 50 Ω)

f (MHz)	S11		S21		S12		S22	
	MAG	ANG (deg.)	MAG	ANG (deg.)	MAG	ANG (deg.)	MAG	ANG (deg.)
400	0.747	-147.9	8.12	94.5	0.060	23.5	0.470	-122.0
500	0.750	-157.7	6.61	88.4	0.062	22.2	0.451	-131.0
600	0.754	-164.9	5.53	83.7	0.063	21.6	0.441	-137.6
700	0.756	-170.2	4.73	79.9	0.064	21.8	0.437	-142.7
800	0.759	-174.7	4.11	76.6	0.065	22.1	0.435	-146.8
900	0.761	-178.4	3.62	73.8	0.066	22.8	0.435	-150.1
1000	0.764	178.2	3.23	71.3	0.068	23.7	0.436	-152.9
1100	0.766	175.2	2.93	68.9	0.069	24.7	0.437	-155.3
1200	0.768	172.5	2.67	66.7	0.070	25.5	0.439	-157.3
1300	0.769	170.0	2.45	64.4	0.072	26.3	0.441	-158.9
1400	0.770	167.5	2.27	62.3	0.073	27.3	0.443	-160.4
1500	0.771	165.1	2.11	60.3	0.075	28.1	0.446	-161.7
1600	0.774	163.0	1.97	58.5	0.077	29.0	0.448	-162.9
1700	0.778	161.0	1.85	56.6	0.079	29.9	0.452	-163.9
1800	0.779	159.1	1.74	54.7	0.080	30.4	0.454	-164.8
1900	0.779	157.2	1.65	52.8	0.082	31.2	0.457	-165.7
2000	0.778	155.4	1.57	51.0	0.084	31.9	0.459	-166.3
2100	0.781	153.5	1.49	49.2	0.087	32.3	0.462	-167.0
2200	0.783	151.6	1.42	47.4	0.089	32.8	0.465	-167.7
2300	0.786	149.9	1.36	45.9	0.091	33.3	0.468	-168.3
2400	0.788	148.4	1.30	44.3	0.094	33.7	0.470	-168.9
2500	0.789	146.9	1.25	42.6	0.096	34.0	0.473	-169.4
2600	0.788	145.2	1.20	40.8	0.098	34.0	0.476	-170.0
2700	0.788	143.4	1.16	39.1	0.101	34.5	0.478	-170.5
2800	0.788	141.7	1.12	37.4	0.104	34.6	0.481	-171.1
2900	0.791	140.2	1.08	35.9	0.107	34.7	0.484	-171.6
3000	0.793	138.8	1.05	34.4	0.110	34.7	0.486	-172.1

## S parameter

 $(V_{CE} = 3.6 \text{ V}, I_C = 20 \text{ mA}, Z_o = 50 \Omega)$ 

f (MHz)	S11		S21		S12		S22	
	MAG	ANG (deg.)	MAG	ANG (deg.)	MAG	ANG (deg.)	MAG	ANG (deg.)
400	0.746	-165.2	9.97	89.5	0.041	31.0	0.494	-144.7
500	0.751	-171.3	7.94	84.9	0.044	32.7	0.491	-151.3
600	0.755	-175.9	6.56	81.4	0.046	34.2	0.491	-156.0
700	0.758	-179.7	5.57	78.4	0.049	36.5	0.492	-159.6
800	0.759	177.0	4.82	75.8	0.051	37.9	0.494	-162.5
900	0.760	174.0	4.25	73.5	0.054	39.3	0.496	-164.9
1000	0.763	171.4	3.79	71.4	0.058	40.5	0.498	-166.9
1100	0.764	169.0	3.42	69.5	0.061	41.6	0.500	-168.7
1200	0.765	166.7	3.12	67.6	0.064	42.5	0.502	-170.2
1300	0.766	164.6	2.87	65.7	0.067	42.9	0.503	-171.5
1400	0.766	162.4	2.66	63.8	0.070	43.7	0.505	-172.7
1500	0.767	160.3	2.47	62.1	0.073	44.0	0.507	-173.8
1600	0.769	158.4	2.31	60.5	0.077	44.5	0.508	-174.7
1700	0.772	156.6	2.17	58.8	0.080	44.6	0.511	-175.5
1800	0.772	155.0	2.04	57.2	0.083	44.5	0.512	-176.4
1900	0.772	153.3	1.93	55.5	0.087	44.7	0.513	-177.1
2000	0.770	151.5	1.84	53.9	0.090	44.6	0.514	-177.7
2100	0.771	149.8	1.75	52.2	0.094	44.4	0.515	-178.3
2200	0.773	148.1	1.67	50.6	0.097	44.2	0.516	-179.0
2300	0.775	146.6	1.60	49.2	0.100	44.0	0.517	-179.6
2400	0.777	145.2	1.53	47.7	0.104	43.7	0.518	179.9
2500	0.777	143.7	1.48	46.2	0.108	43.3	0.519	179.4
2600	0.775	142.1	1.42	44.5	0.111	42.9	0.519	178.9
2700	0.774	140.4	1.37	42.9	0.115	42.6	0.520	178.3
2800	0.775	138.8	1.32	41.3	0.118	42.0	0.521	177.8
2900	0.776	137.4	1.28	39.9	0.121	41.5	0.521	177.3
3000	0.778	136.1	1.24	38.5	0.125	40.8	0.522	176.7

## S parameter

 $(V_{CE} = 3.6 \text{ V}, I_C = 30 \text{ mA}, Z_o = 50 \Omega)$ 

f (MHz)	S11		S21		S12		S22	
	MAG	ANG (deg.)	MAG	ANG (deg.)	MAG	ANG (deg.)	MAG	ANG (deg.)
400	0.751	-171.6	10.66	87.6	0.034	38.4	0.519	-153.4
500	0.755	-176.4	8.45	83.7	0.037	41.4	0.520	-158.7
600	0.759	179.8	6.96	80.5	0.040	43.3	0.523	-162.5
700	0.761	176.6	5.90	77.8	0.044	45.3	0.525	-165.5
800	0.762	173.7	5.11	75.5	0.048	46.4	0.527	-168.0
900	0.763	171.0	4.50	73.4	0.051	47.7	0.529	-170.0
1000	0.765	168.6	4.01	71.5	0.055	48.8	0.532	-171.7
1100	0.766	166.5	3.63	69.8	0.059	49.5	0.534	-173.2
1200	0.767	164.4	3.30	68.0	0.063	50.1	0.536	-174.6
1300	0.767	162.4	3.04	66.3	0.067	50.3	0.537	-175.8
1400	0.767	160.3	2.82	64.5	0.071	50.5	0.539	-176.9
1500	0.767	158.3	2.62	62.9	0.074	50.5	0.540	-177.9
1600	0.768	156.5	2.45	61.4	0.078	50.5	0.541	-178.7
1700	0.772	154.8	2.30	59.8	0.082	50.3	0.543	-179.5
1800	0.771	153.3	2.17	58.3	0.086	50.0	0.544	179.7
1900	0.771	151.6	2.05	56.7	0.090	49.8	0.544	179.0
2000	0.769	150.0	1.95	55.1	0.093	49.4	0.545	178.4
2100	0.769	148.2	1.86	53.5	0.097	48.9	0.546	177.8
2200	0.770	146.6	1.78	52.0	0.101	48.4	0.546	177.1
2300	0.773	145.1	1.70	50.6	0.105	47.9	0.546	176.5
2400	0.774	143.7	1.63	49.2	0.109	47.4	0.546	175.9
2500	0.774	142.4	1.57	47.7	0.113	46.8	0.547	175.4
2600	0.772	140.8	1.51	46.1	0.116	46.0	0.547	174.8
2700	0.771	139.1	1.46	44.6	0.120	45.6	0.547	174.3
2800	0.771	137.6	1.41	43.0	0.124	44.9	0.547	173.7
2900	0.772	136.2	1.37	41.7	0.128	44.1	0.547	173.2
3000	0.773	134.8	1.33	40.3	0.132	43.3	0.547	172.6

## S parameter

(V<sub>CE</sub> = 3.6 V, I<sub>C</sub> = 50 mA, Z<sub>o</sub> = 50 Ω)

f (MHz)	S11		S21		S12		S22	
	MAG	ANG (deg.)	MAG	ANG (deg.)	MAG	ANG (deg.)	MAG	ANG (deg.)
400	0.758	-177.0	11.23	86.1	0.029	48.2	0.548	-160.4
500	0.761	179.2	8.87	82.7	0.033	51.3	0.552	-164.7
600	0.764	176.1	7.30	79.9	0.037	53.2	0.556	-167.8
700	0.766	173.4	6.19	77.5	0.041	54.8	0.559	-170.2
800	0.766	170.8	5.36	75.4	0.046	55.7	0.561	-172.3
900	0.766	168.4	4.72	73.5	0.050	56.3	0.564	-174.0
1000	0.768	166.3	4.21	71.7	0.055	56.6	0.566	-175.5
1100	0.769	164.3	3.81	70.1	0.059	57.0	0.568	-176.9
1200	0.769	162.3	3.47	68.5	0.063	56.9	0.570	-178.1
1300	0.769	160.5	3.19	66.9	0.067	56.7	0.571	-179.1
1400	0.768	158.5	2.96	65.2	0.072	56.5	0.572	179.9
1500	0.768	156.6	2.75	63.7	0.076	56.0	0.573	178.9
1600	0.769	154.9	2.58	62.3	0.080	55.8	0.574	178.1
1700	0.772	153.2	2.42	60.8	0.085	55.2	0.576	177.3
1800	0.772	151.7	2.28	59.3	0.089	54.6	0.576	176.6
1900	0.771	150.1	2.16	57.8	0.093	54.1	0.576	175.9
2000	0.768	148.5	2.05	56.3	0.097	53.4	0.576	175.3
2100	0.769	146.8	1.96	54.8	0.101	52.7	0.577	174.7
2200	0.770	145.2	1.87	53.3	0.105	52.0	0.577	174.0
2300	0.772	143.8	1.79	52.0	0.109	51.3	0.577	173.4
2400	0.773	142.4	1.72	50.7	0.113	50.5	0.576	172.8
2500	0.772	141.1	1.66	49.2	0.118	49.8	0.576	172.2
2600	0.770	139.5	1.60	47.7	0.121	48.9	0.576	171.7
2700	0.769	137.9	1.54	46.2	0.126	48.2	0.575	171.1
2800	0.768	136.4	1.49	44.7	0.130	47.2	0.575	170.5
2900	0.769	135.0	1.44	43.3	0.134	46.4	0.574	169.9
3000	0.771	133.7	1.40	42.0	0.138	45.4	0.574	169.3

## S parameter

(V<sub>CE</sub> = 3.6 V, I<sub>C</sub> = 70 mA, Z<sub>o</sub> = 50 Ω)

f (MHz)	S11		S21		S12		S22	
	MAG	ANG (deg.)	MAG	ANG (deg.)	MAG	ANG (deg.)	MAG	ANG (deg.)
400	0.762	-179.4	11.46	85.5	0.027	53.7	0.565	-163.5
500	0.765	177.3	9.05	82.3	0.031	56.9	0.568	-167.3
600	0.767	174.5	7.44	79.6	0.036	58.5	0.573	-170.0
700	0.768	171.9	6.31	77.4	0.041	59.5	0.576	-172.2
800	0.769	169.5	5.47	75.4	0.045	59.9	0.578	-174.2
900	0.769	167.2	4.81	73.5	0.050	60.2	0.581	-175.8
1000	0.770	165.2	4.30	71.9	0.055	60.3	0.583	-177.2
1100	0.771	163.3	3.88	70.3	0.059	60.4	0.585	-178.4
1200	0.771	161.4	3.54	68.8	0.064	60.3	0.587	-179.6
1300	0.770	159.6	3.26	67.2	0.068	59.5	0.588	179.4
1400	0.770	157.7	3.02	65.6	0.072	59.2	0.589	178.4
1500	0.770	155.8	2.81	64.1	0.077	58.7	0.590	177.5
1600	0.771	154.1	2.63	62.8	0.082	58.3	0.590	176.8
1700	0.773	152.5	2.48	61.3	0.086	57.4	0.592	176.0
1800	0.773	151.0	2.33	59.9	0.090	56.6	0.592	175.2
1900	0.772	149.5	2.21	58.4	0.094	56.1	0.592	174.5
2000	0.769	147.8	2.10	56.9	0.099	55.2	0.592	174.0
2100	0.770	146.2	2.01	55.4	0.103	54.5	0.592	173.3
2200	0.770	144.6	1.92	54.0	0.107	53.6	0.592	172.7
2300	0.772	143.1	1.84	52.7	0.111	52.9	0.592	172.1
2400	0.773	141.8	1.76	51.4	0.116	52.0	0.591	171.5
2500	0.773	140.5	1.70	50.0	0.120	51.1	0.591	170.9
2600	0.770	138.9	1.63	48.5	0.124	50.1	0.590	170.3
2700	0.769	137.4	1.58	47.0	0.128	49.3	0.590	169.7
2800	0.768	135.8	1.53	45.5	0.132	48.4	0.589	169.1
2900	0.769	134.4	1.48	44.2	0.136	47.4	0.588	168.5
3000	0.770	133.1	1.44	42.8	0.140	46.4	0.588	167.9

## S parameter

(V<sub>CE</sub> = 3.6 V, I<sub>C</sub> = 100 mA, Z<sub>o</sub> = 50 Ω)

f (MHz)	S11		S21		S12		S22	
	MAG	ANG (deg.)	MAG	ANG (deg.)	MAG	ANG (deg.)	MAG	ANG (deg.)
400	0.766	178.7	11.59	85.0	0.025	59.6	0.578	-165.8
500	0.768	175.8	9.14	82.0	0.030	61.7	0.582	-169.2
600	0.770	173.2	7.52	79.5	0.035	62.5	0.586	-171.7
700	0.771	170.8	6.38	77.3	0.040	63.3	0.590	-173.8
800	0.772	168.5	5.53	75.4	0.045	63.4	0.592	-175.6
900	0.772	166.3	4.87	73.7	0.050	63.3	0.595	-177.1
1000	0.772	164.3	4.35	72.1	0.055	63.3	0.597	-178.4
1100	0.773	162.5	3.93	70.6	0.059	63.2	0.598	-179.6
1200	0.773	160.7	3.58	69.1	0.064	62.5	0.600	179.3
1300	0.772	158.9	3.30	67.6	0.069	61.8	0.601	178.3
1400	0.772	157.0	3.06	66.0	0.073	61.4	0.602	177.4
1500	0.771	155.1	2.85	64.5	0.078	60.7	0.603	176.5
1600	0.772	153.5	2.67	63.2	0.082	60.0	0.603	175.8
1700	0.775	151.9	2.51	61.8	0.087	59.2	0.604	175.0
1800	0.774	150.5	2.37	60.4	0.091	58.3	0.605	174.2
1900	0.773	148.9	2.24	58.9	0.096	57.7	0.604	173.5
2000	0.771	147.3	2.13	57.4	0.100	56.8	0.604	173.0
2100	0.771	145.7	2.04	56.0	0.105	55.8	0.604	172.4
2200	0.771	144.1	1.95	54.5	0.109	54.9	0.604	171.7
2300	0.774	142.7	1.87	53.3	0.113	54.1	0.604	171.1
2400	0.774	141.4	1.79	52.0	0.117	53.1	0.603	170.5
2500	0.774	140.0	1.72	50.6	0.122	52.3	0.603	169.9
2600	0.771	138.5	1.66	49.1	0.126	51.2	0.602	169.3
2700	0.769	136.9	1.60	47.6	0.130	50.3	0.601	168.7
2800	0.769	135.4	1.55	46.1	0.135	49.4	0.601	168.1
2900	0.770	134.0	1.50	44.8	0.139	48.3	0.600	167.5
3000	0.771	132.7	1.46	43.5	0.143	47.2	0.599	166.8

## S parameter

(V<sub>CE</sub> = 3.6 V, I<sub>C</sub> = 150 mA, Z<sub>o</sub> = 50 Ω)

f (MHz)	S11		S21		S12		S22	
	MAG	ANG (deg.)	MAG	ANG (deg.)	MAG	ANG (deg.)	MAG	ANG (deg.)
400	0.770	177.2	11.57	84.7	0.025	64.9	0.589	-167.6
500	0.773	174.5	9.13	81.8	0.030	65.7	0.594	-170.7
600	0.775	172.2	7.50	79.4	0.035	66.4	0.598	-173.0
700	0.776	169.9	6.37	77.4	0.040	66.9	0.601	-175.0
800	0.776	167.7	5.52	75.5	0.045	66.2	0.603	-176.7
900	0.775	165.6	4.87	73.9	0.050	66.1	0.606	-178.1
1000	0.776	163.6	4.35	72.4	0.055	65.4	0.607	-179.4
1100	0.777	161.9	3.93	70.9	0.060	65.3	0.609	179.5
1200	0.777	160.1	3.59	69.4	0.065	64.4	0.610	178.4
1300	0.776	158.3	3.31	67.9	0.069	63.5	0.611	177.5
1400	0.775	156.4	3.07	66.4	0.074	63.0	0.612	176.5
1500	0.775	154.6	2.86	64.9	0.079	62.3	0.612	175.7
1600	0.776	153.0	2.68	63.6	0.083	61.5	0.613	175.0
1700	0.778	151.4	2.52	62.2	0.088	60.6	0.614	174.2
1800	0.778	150.0	2.38	60.8	0.092	59.6	0.614	173.4
1900	0.776	148.5	2.25	59.3	0.097	58.9	0.614	172.8
2000	0.774	146.9	2.14	57.9	0.101	57.9	0.613	172.2
2100	0.774	145.2	2.05	56.4	0.106	57.0	0.614	171.6
2200	0.774	143.7	1.96	55.0	0.110	56.0	0.614	170.9
2300	0.776	142.2	1.88	53.8	0.115	55.0	0.613	170.3
2400	0.777	141.0	1.80	52.5	0.119	54.1	0.612	169.7
2500	0.776	139.6	1.73	51.1	0.123	53.2	0.612	169.1
2600	0.774	138.1	1.67	49.6	0.128	52.1	0.611	168.5
2700	0.772	136.5	1.61	48.1	0.132	51.1	0.610	167.9
2800	0.771	135.0	1.56	46.6	0.136	50.1	0.610	167.3
2900	0.772	133.6	1.51	45.3	0.141	49.1	0.608	166.7
3000	0.773	132.3	1.47	44.0	0.145	48.0	0.608	166.0



## S parameter

(V<sub>CE</sub> = 3.6 V, I<sub>C</sub> = 200 mA, Z<sub>o</sub> = 50 Ω)

f (MHz)	S11		S21		S12		S22	
	MAG	ANG (deg.)	MAG	ANG (deg.)	MAG	ANG (deg.)	MAG	ANG (deg.)
400	0.776	176.4	11.40	84.6	0.025	67.7	0.594	-168.5
500	0.777	173.9	8.99	81.8	0.030	67.8	0.599	-171.5
600	0.780	171.6	7.40	79.5	0.035	68.3	0.603	-173.7
700	0.780	169.4	6.28	77.5	0.040	68.2	0.606	-175.6
800	0.780	167.2	5.45	75.7	0.045	67.8	0.608	-177.3
900	0.780	165.2	4.81	74.1	0.050	67.1	0.610	-178.7
1000	0.780	163.3	4.30	72.6	0.055	66.6	0.612	-180.0
1100	0.781	161.5	3.89	71.1	0.060	66.4	0.613	178.9
1200	0.781	159.8	3.55	69.6	0.065	65.6	0.614	177.9
1300	0.780	158.0	3.27	68.1	0.070	64.6	0.615	177.0
1400	0.779	156.2	3.04	66.6	0.074	63.9	0.616	176.1
1500	0.779	154.4	2.83	65.1	0.079	63.1	0.616	175.2
1600	0.780	152.7	2.65	63.8	0.084	62.3	0.617	174.6
1700	0.782	151.2	2.50	62.4	0.089	61.2	0.619	173.8
1800	0.781	149.8	2.36	61.0	0.093	60.4	0.618	173.0
1900	0.780	148.3	2.23	59.5	0.097	59.5	0.618	172.4
2000	0.777	146.7	2.12	58.1	0.102	58.5	0.617	171.8
2100	0.778	145.0	2.03	56.6	0.107	57.5	0.617	171.2
2200	0.778	143.5	1.94	55.2	0.111	56.6	0.617	170.5
2300	0.780	142.0	1.86	53.9	0.115	55.7	0.617	169.9
2400	0.780	140.7	1.79	52.6	0.120	54.6	0.616	169.3
2500	0.780	139.4	1.72	51.2	0.124	53.6	0.615	168.8
2600	0.777	137.9	1.66	49.7	0.128	52.6	0.615	168.1
2700	0.776	136.3	1.60	48.2	0.133	51.5	0.614	167.5
2800	0.775	134.8	1.55	46.8	0.137	50.6	0.613	166.9
2900	0.776	133.4	1.50	45.5	0.142	49.5	0.612	166.3
3000	0.777	132.1	1.46	44.2	0.146	48.4	0.611	165.6

## S parameter

(V<sub>CE</sub> = 3.6 V, I<sub>C</sub> = 250 mA, Z<sub>o</sub> = 50 Ω)

f (MHz)	S11		S21		S12		S22	
	MAG	ANG (deg.)	MAG	ANG (deg.)	MAG	ANG (deg.)	MAG	ANG (deg.)
400	0.749	-169.0	10.38	88.4	0.037	34.8	0.508	-149.8
500	0.753	-174.3	8.24	84.2	0.040	37.6	0.507	-155.7
600	0.757	-178.4	6.79	80.9	0.043	39.3	0.509	-159.9
700	0.759	178.1	5.76	78.1	0.046	41.2	0.511	-163.1
800	0.761	175.0	4.99	75.6	0.049	42.9	0.513	-165.8
900	0.762	172.3	4.39	73.4	0.052	44.1	0.515	-168.0
1000	0.763	169.7	3.92	71.5	0.056	45.2	0.518	-169.8
1100	0.765	167.5	3.54	69.7	0.060	46.2	0.519	-171.4
1200	0.766	165.4	3.23	67.8	0.063	46.8	0.521	-172.9
1300	0.766	163.3	2.97	66.0	0.067	47.0	0.523	-174.1
1400	0.766	161.2	2.75	64.3	0.070	47.5	0.525	-175.2
1500	0.766	159.1	2.56	62.6	0.074	47.8	0.526	-176.2
1600	0.768	157.3	2.39	61.0	0.078	48.0	0.527	-177.1
1700	0.772	155.6	2.25	59.4	0.081	47.9	0.529	-177.9
1800	0.772	154.0	2.12	57.8	0.085	47.8	0.530	-178.8
1900	0.771	152.3	2.00	56.2	0.088	47.6	0.531	-179.5
2000	0.769	150.6	1.90	54.6	0.092	47.4	0.531	179.9
2100	0.770	148.9	1.82	53.0	0.096	47.1	0.532	179.3
2200	0.771	147.2	1.73	51.4	0.100	46.6	0.533	178.7
2300	0.774	145.7	1.66	50.0	0.103	46.4	0.534	178.1
2400	0.775	144.3	1.59	48.6	0.107	45.9	0.534	177.5
2500	0.775	142.9	1.53	47.1	0.110	45.4	0.534	177.0
2600	0.773	141.3	1.47	45.5	0.114	44.7	0.535	176.4
2700	0.772	139.7	1.42	43.9	0.118	44.3	0.535	175.9
2800	0.772	138.1	1.37	42.3	0.121	43.7	0.535	175.4
2900	0.774	136.7	1.33	41.0	0.125	43.1	0.535	174.8
3000	0.775	135.3	1.29	39.5	0.129	42.3	0.535	174.3

### Package Dimensions

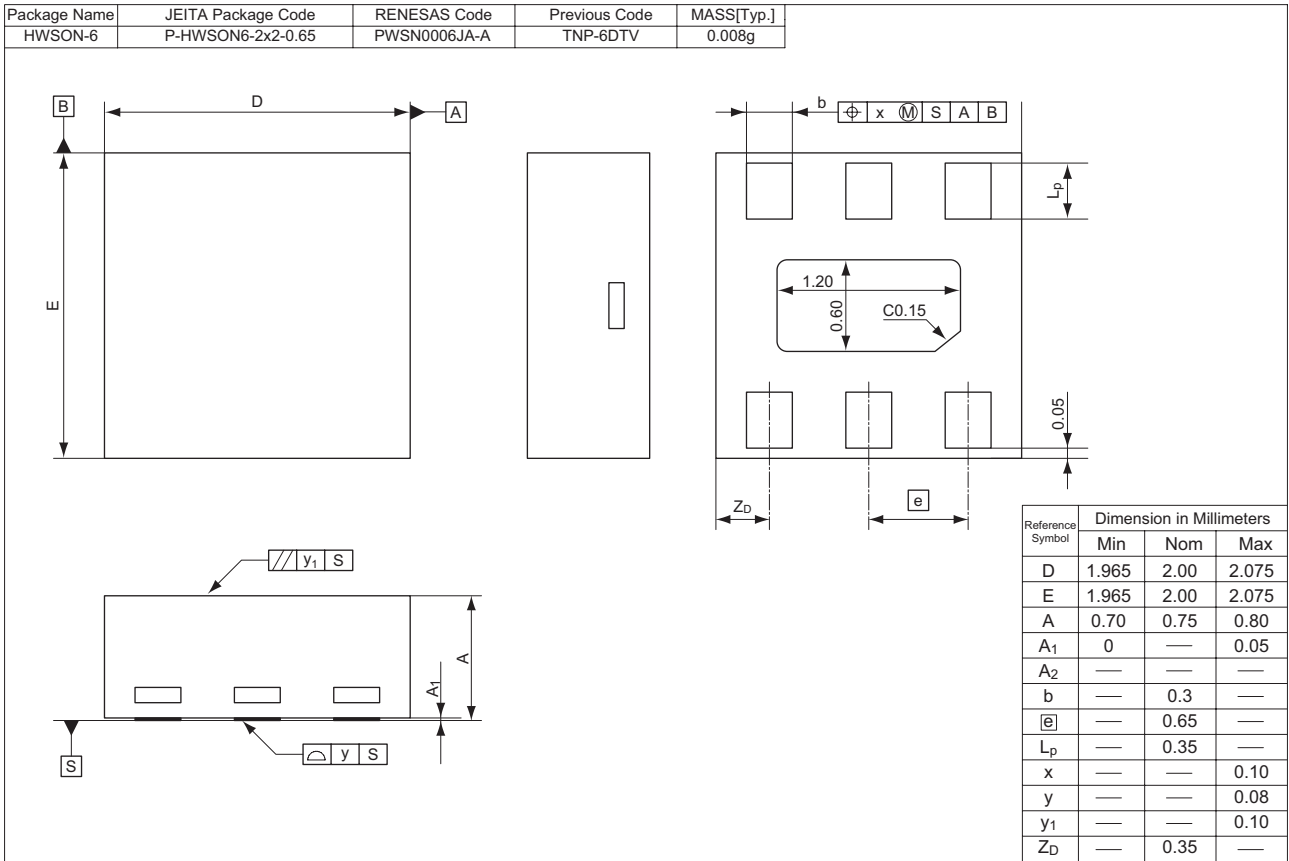

### Ordering Information

Part Name	Quantity	Shipping Container
2SC5945TR-E	3000 pcs.	φ178 mm Reel, 8 mm Emboss Taping

Note: Therefore especially small contact area of terminal, miss contact may occur if inadequate soldering condition is applied.

Contact Renesas sales office for any question regarding recommended soldering condition of Renesas.

**Keep safety first in your circuit designs!**

1. Renesas Technology Corp. puts the maximum effort into making semiconductor products better and more reliable, but there is always the possibility that trouble may occur with them. Trouble with semiconductors may lead to personal injury, fire or property damage.  
Remember to give due consideration to safety when making your circuit designs, with appropriate measures such as (i) placement of substitutive, auxiliary circuits, (ii) use of nonflammable material or (iii) prevention against any malfunction or mishap.

**Notes regarding these materials**

1. These materials are intended as a reference to assist our customers in the selection of the Renesas Technology Corp. product best suited to the customer's application; they do not convey any license under any intellectual property rights, or any other rights, belonging to Renesas Technology Corp. or a third party.
  2. Renesas Technology Corp. assumes no responsibility for any damage, or infringement of any third-party's rights, originating in the use of any product data, diagrams, charts, programs, algorithms, or circuit application examples contained in these materials.
  3. All information contained in these materials, including product data, diagrams, charts, programs and algorithms represents information on products at the time of publication of these materials, and are subject to change by Renesas Technology Corp. without notice due to product improvements or other reasons. It is therefore recommended that customers contact Renesas Technology Corp. or an authorized Renesas Technology Corp. product distributor for the latest product information before purchasing a product listed herein.  
The information described here may contain technical inaccuracies or typographical errors.  
Renesas Technology Corp. assumes no responsibility for any damage, liability, or other loss rising from these inaccuracies or errors.  
Please also pay attention to information published by Renesas Technology Corp. by various means, including the Renesas Technology Corp. Semiconductor home page (<http://www.renesas.com>).
  4. When using any or all of the information contained in these materials, including product data, diagrams, charts, programs, and algorithms, please be sure to evaluate all information as a total system before making a final decision on the applicability of the information and products. Renesas Technology Corp. assumes no responsibility for any damage, liability or other loss resulting from the information contained herein.
  5. Renesas Technology Corp. semiconductors are not designed or manufactured for use in a device or system that is used under circumstances in which human life is potentially at stake. Please contact Renesas Technology Corp. or an authorized Renesas Technology Corp. product distributor when considering the use of a product contained herein for any specific purposes, such as apparatus or systems for transportation, vehicular, medical, aerospace, nuclear, or undersea repeater use.
  6. The prior written approval of Renesas Technology Corp. is necessary to reprint or reproduce in whole or in part these materials.
  7. If these products or technologies are subject to the Japanese export control restrictions, they must be exported under a license from the Japanese government and cannot be imported into a country other than the approved destination.  
Any diversion or reexport contrary to the export control laws and regulations of Japan and/or the country of destination is prohibited.
  8. Please contact Renesas Technology Corp. for further details on these materials or the products contained therein.
- 



**RENESAS SALES OFFICES**

<http://www.renesas.com>

Refer to "<http://www.renesas.com/en/network>" for the latest and detailed information.

**Renesas Technology America, Inc.**

450 Holger Way, San Jose, CA 95134-1368, U.S.A  
Tel: <1> (408) 382-7500, Fax: <1> (408) 382-7501

**Renesas Technology Europe Limited**

Dukes Meadow, Millboard Road, Bourne End, Buckinghamshire, SL8 5FH, U.K.  
Tel: <44> (1628) 585-100, Fax: <44> (1628) 585-900

**Renesas Technology (Shanghai) Co., Ltd.**

Unit 204, 205, AZIACenter, No.1233 Lujiazui Ring Rd, Pudong District, Shanghai, China 200120  
Tel: <86> (21) 5877-1818, Fax: <86> (21) 6887-7898

**Renesas Technology Hong Kong Ltd.**

7th Floor, North Tower, World Finance Centre, Harbour City, 1 Canton Road, Tsimshatsui, Kowloon, Hong Kong  
Tel: <852> 2265-6688, Fax: <852> 2730-6071

**Renesas Technology Taiwan Co., Ltd.**

10th Floor, No.99, Fushing North Road, Taipei, Taiwan  
Tel: <886> (2) 2715-2888, Fax: <886> (2) 2713-2999

**Renesas Technology Singapore Pte. Ltd.**

1 Harbour Front Avenue, #06-10, Keppel Bay Tower, Singapore 098632  
Tel: <65> 6213-0200, Fax: <65> 6278-8001

**Renesas Technology Korea Co., Ltd.**

Kukje Center Bldg. 18th Fl., 191, 2-ka, Hangang-ro, Yongsan-ku, Seoul 140-702, Korea  
Tel: <82> (2) 796-3115, Fax: <82> (2) 796-2145

**Renesas Technology Malaysia Sdn. Bhd**

Unit 906, Block B, Menara Amcorp, Amcorp Trade Centre, No.18, Jalan Persiaran Barat, 46050 Petaling Jaya, Selangor Darul Ehsan, Malaysia  
Tel: <603> 7955-9390, Fax: <603> 7955-9510