

## General Description

The AAT1184 is a single output step-down (Buck) DC output regulator with an integrated high side MOSFET. The input range is 6V to 24V making it the ideal power IC solution for consumer communications equipment operating from a low cost AC/DC adapter with 12V output.

The step-down regulator provides up to 1.2A output current in a small package. 490kHz fixed switching frequency allows small L/C filtering components.

Voltage mode control allows for optimum performance across the entire output voltage and load range.

The controller includes programmable over-current, integrated soft-start and over-temperature protection.

The AAT1184 is available in the Pb-free, low profile 12-pin TSOPJW package. The rated operating temperature range is -40°C to 85°C.

## Features

- $V_{IN}$  = 6.0 to 24.0V
- $V_{OUT}$  Adjustable from 1.5V to 5.5V
- $I_{OUT}$  up to 1.2A
- Small Solution Size
- Low-Cost Non-Synchronous Solution
- Shutdown Current <35 $\mu$ A
- High Switching Frequency
- Voltage Mode Control
- PWM Fixed Frequency for Lowest Noise
  - Programmable Over-Current Protection
- Over-Temperature Protection
- Internal Soft Start
- Low Profile 3x3mm TSOPJW-12 Package
- -40°C to 85°C Temperature Range

## Applications

- DSL and Cable Modems
- Notebook Computers
- Satellite Set Top Box
- Wireless LAN Systems

## Typical Application

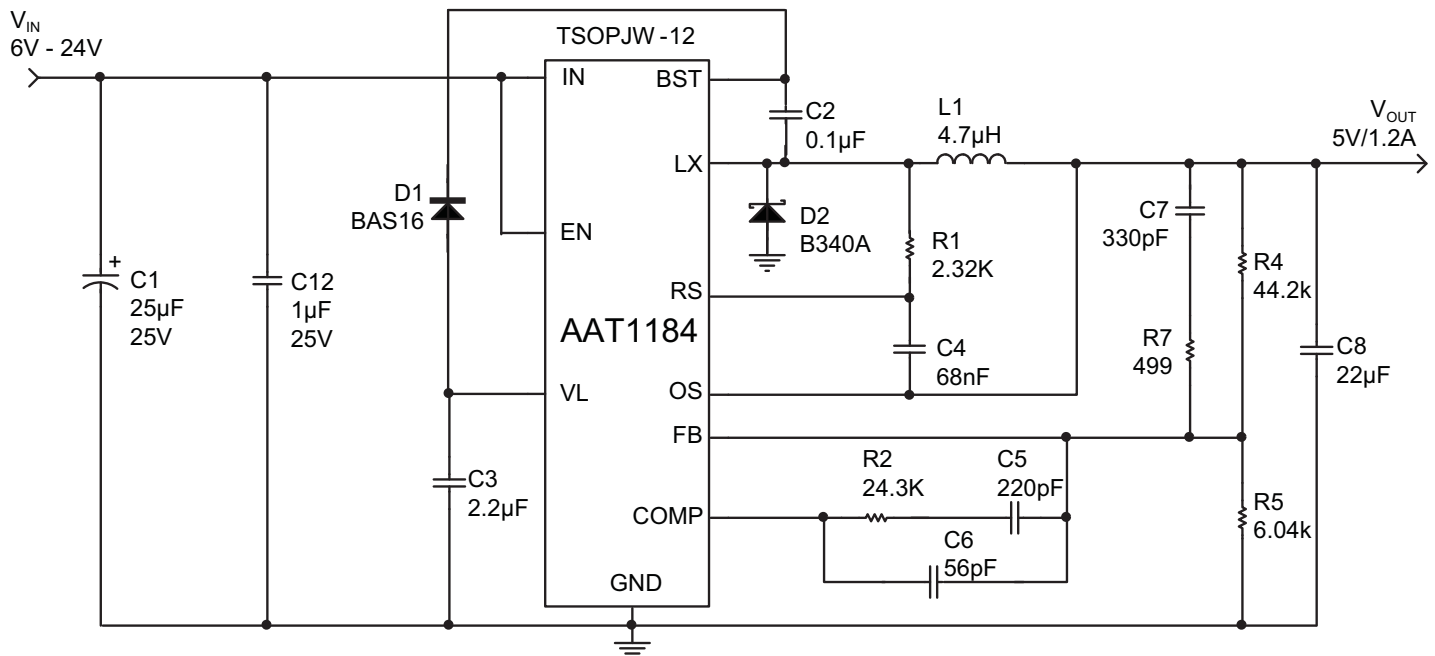

## Pin Descriptions

Pin #	Symbol	Function
1	RS	Output current sense pin. Connect a small signal resistor from this pin to switching node (LX) to enable over-current sense for step-down converter.
2	EN	Enable input pin. Active high.
3	BST	Boost drive input pin. Connect the cathode of fast rectifier from this pin and connect a 100nF capacitor from this pin to the switching node (LX) for internal hi-side MOSFET gate drive.
4, 5	LX	Step-down converter switching pin. Connect output inductor to this pin. Connect LX pins together.
6, 7	IN	Input supply voltage pin for step-down regulator. Connect both IN pins together. Connect the input capacitor close to this pin for best noise performance.
8	VL	Internal linear regulator. Connect a 2.2μF/6.3V capacitor from this pin to GND pin.
9	GND	Ground pin for step-down converter. Connect input and output capacitors return terminals close to this pin for best noise performance.
10	FB	Feedback input pin for step-down converter. Connect an external resistor divider to this pin to program the output voltage to the desired value.
11	COMP	Compensation pin for step-down regulator. Connect a series resistor, capacitor network to compensate the voltage mode control loop.
12	OS	Output voltage sense pin. Connect to the output capacitor to enable over-current sense for step-down converter.

## Pin Configuration

**TSOPJW-12**  
(Top View)

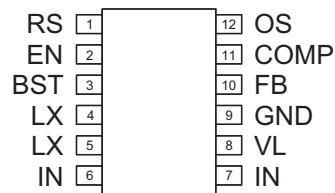

**Absolute Maximum Ratings<sup>1</sup>**

Symbol	Description	Value	Units
$V_{IN(HI)}$	IN, LX to GND	-0.3 to 30.0	V
$V_{IN(LO)}$	VL to GND	-0.3 to 6.0	V
$V_{BST1-LX}$	BST to LX	-0.3 to 6.0	V
$V_{CONTROL}$	FB, COMP, OS, RS to GND	-0.3 to $V_{IN(LO)} + 0.3$	V
$V_{EN}$	EN to GND	-0.3 to 6.0	V
$I_{IN(PULSED)}$	IN to LX	12.0	A
$T_J$	Operating Junction Temperature Range	-40 to 150	°C
$T_{LEAD}$	Maximum Soldering Temperature (at leads, 10 sec)	300	°C

**Thermal Information**

Symbol	Description	Value	Units
$\Theta_{JA}$	Thermal Resistance	140	C/W
$P_D$	Maximum Power Dissipation <sup>2</sup>	0.7	W

1. Stresses above those listed in Absolute Maximum Ratings may cause permanent damage to the device. Functional operation at conditions other than the operating conditions specified is not implied. Only one Absolute Maximum Rating should be applied at any one time.

2. Derate 7mW/°C above 25°C ambient temperature.

## Electrical Characteristics<sup>1</sup>

$V_{IN} = 12V$ ;  $T_A = -40^{\circ}C$  to  $85^{\circ}C$ , unless noted otherwise. Typical values are at  $T_A = 25^{\circ}C$ .

Symbol	Description	Conditions	Min	Typ	Max	Units
$V_{IN}$	Input Voltage		6.0		24.0	V
$V_{UVLO}$	UVLO Threshold	$V_{IN}$ Rising			5.0	V
		$V_{IN}$ Hysteresis		300		mV
		$V_{IN}$ Falling	3.0			V
$V_{OUT}$	Output Voltage Range		1.5		5.5	V
	Output Voltage Accuracy	$I_{OUT} = 0A$ to $1.2A$	-2.5		2.5	%
$V_{FB}$	Feedback Pin Voltage		0.591	0.600	0.609	V
$\frac{\Delta V_{LINEREG}}{\Delta V_{IN}}$	Line Regulation	$V_{IN} = 6V$ to $24V$ , $V_{OUT} = 3.3V$ , $I_{OUT} = 1.2A$		0.02		% / V
		$V_{IN} = 6V$ to $24V$ , $V_{OUT} = 5.0V$ , $I_{OUT} = 1.2A$		0.2		
$\frac{\Delta V_{LOADREG}}{\Delta I_{IN}}$	Load Regulation	$V_{IN} = 12V$ , $V_{OUT} = 3.3V$ , $I_{OUT} = 0A$ to $1.2A$		0.4		% / A
		$V_{IN} = 12V$ , $V_{OUT} = 5V$ , $I_{OUT} = 0A$ to $1.2A$		2.5		
$I_Q$	Quiescent Current	$V_{EN} = \text{High}$ , No load		0.6		mA
$I_{SHDN}$	Shutdown Current	$V_{EN} = \text{Low}$ , $V_L = 0V$			35.0	$\mu A$
$V_{OCP}$	Over-Current Offset Voltage	$V_{EN} = \text{High}$ , $V_{IN} = 6.0V$ to $24.0V$ , $T_A = 25^{\circ}C$	80	100	120	mV
$I_{LX}$	LX Pin Leakage Current	$V_{IN} = 24.0V$ , $V_{EN} = \text{Low}$	-1.0		1.0	$\mu A$
$D_{MAX}$	Maximum Duty Cycle			85		%
$T_{ON(MIN)}$	Minimum On-Time	$V_{IN} = 6.0$ to $24.0V$		100		ns
$R_{DS(ON)(H)}$	Hi Side On-Resistance	$V_L = 4.5V$		70		$m\Omega$
$F_{OSC}$	Oscillator Frequency		350	490	650	kHz
$F_{FOLDBACK}$	Short Circuit Foldback Frequency	Current Limit Triggered		100		kHz
$T_{SS}$	Soft-Start Time	From Enable to Output Regulation		2.5		ms
$T_{SD}$	Over-Temperature Shutdown Threshold			135		$^{\circ}C$
	Over-Temperature Shutdown Hysteresis			15		$^{\circ}C$
$V_{EN(L)}$	Enable Threshold Low				0.6	V
$V_{EN(H)}$	Enable Threshold High		2.5			V
$I_{EN}$	Input Low Current		-1.0		1.0	$\mu A$

1. The AAT1184 is guaranteed to meet performance specifications over the  $-40^{\circ}C$  to  $+85^{\circ}C$  operating temperature range and is assured by design, characterization and correlation with statistical process controls.

Typical Characteristics

Step-Down Converter Efficiency vs. Load  
( $V_{OUT} = 3.3V$ ;  $L = 4.7\mu H$ )

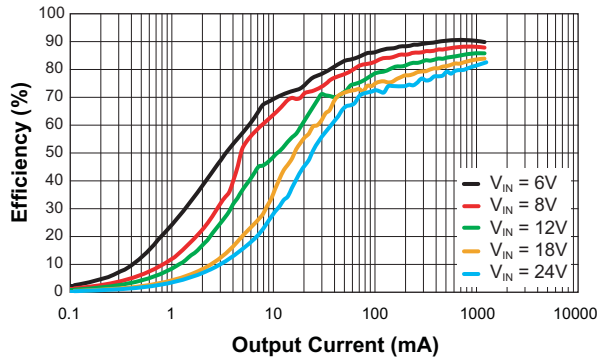

Step-Down Converter Efficiency vs. Load  
( $V_{OUT} = 5V$ ;  $L = 4.7\mu H$ )

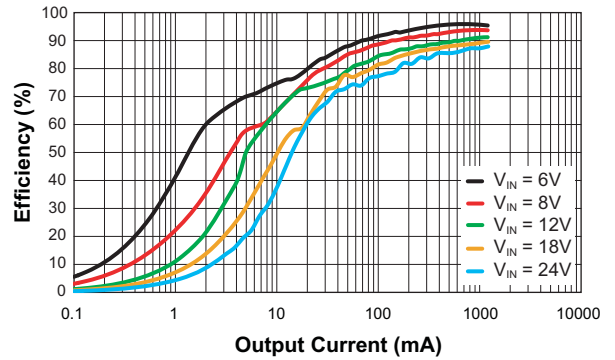

Step-Down Converter DC Regulation  
( $V_{OUT} = 3.3V$ ;  $L = 4.7\mu H$ )

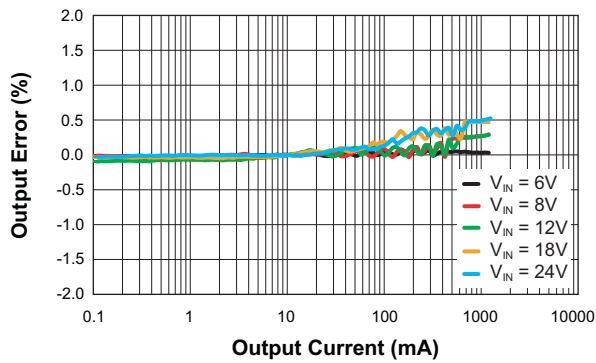

Step-Down Converter DC Regulation  
( $V_{OUT} = 5V$ ;  $L = 4.7\mu H$ )

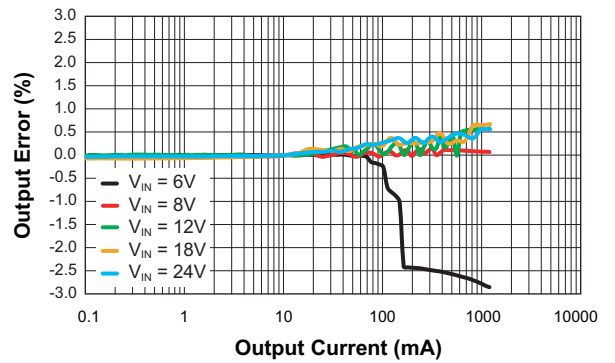

Step-Down Converter Line Regulation  
( $V_{OUT} = 3.3V$ ;  $L = 4.7\mu H$ )

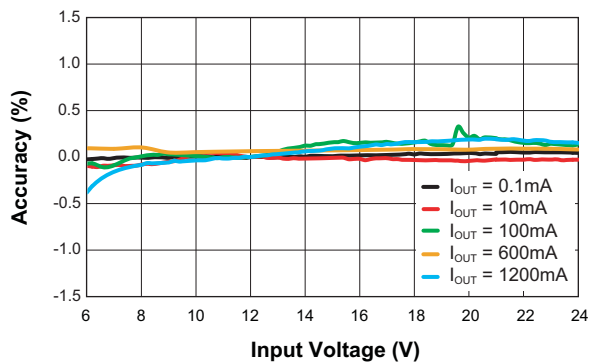

Step-Down Converter Line Regulation  
( $V_{OUT} = 5V$ ;  $L = 4.7\mu H$ )

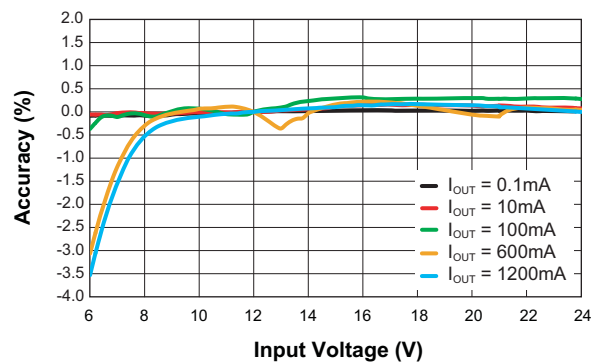

### Typical Characteristics

**Step-Down Converter Output Ripple**  
( $V_{IN} = 12V$ ;  $V_{OUT} = 3.3V$ ;  $I_{OUT} = 1mA$ )

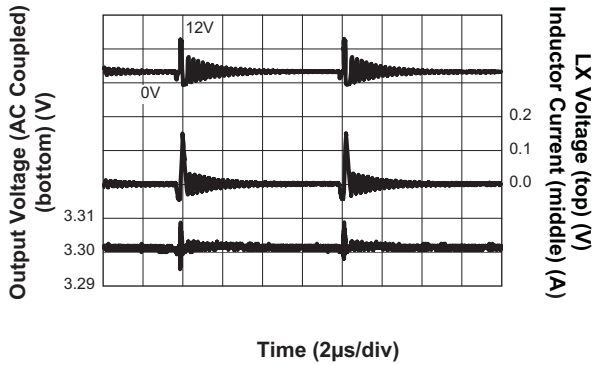

**Step-Down Converter Output Ripple**  
( $V_{IN} = 12V$ ;  $V_{OUT} = 5V$ ;  $I_{OUT} = 1mA$ )

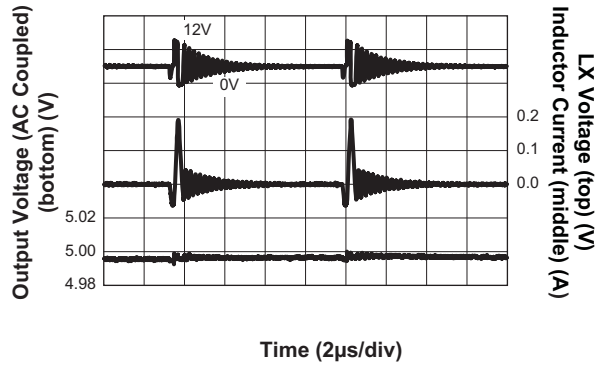

**Step-Down Converter Output Ripple**  
( $V_{IN} = 12V$ ;  $V_{OUT} = 3.3V$ ;  $I_{OUT} = 1.2A$ )

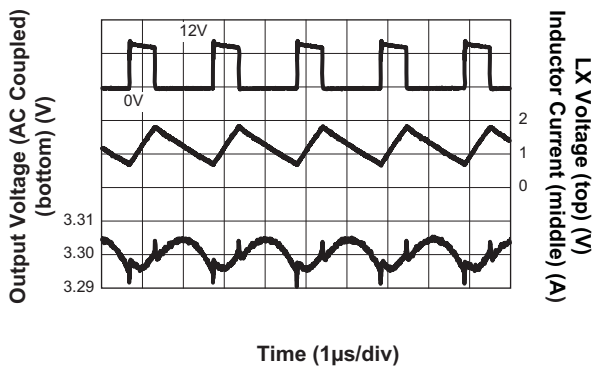

**Step-Down Converter Output Ripple**  
( $V_{IN} = 12V$ ;  $V_{OUT} = 5V$ ;  $I_{OUT} = 1.2mA$ )

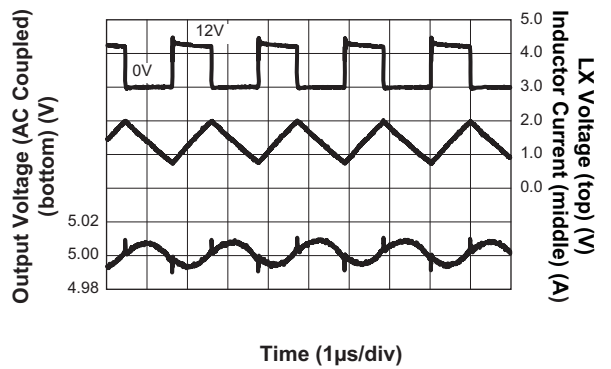

**Step-Down Converter Load Transient Response**  
( $I_{OUT} = 0.12A$  to  $1.2A$ ;  $V_{IN} = 12V$ ;  $V_{OUT} = 3.3V$ ;  $C_{OUT} = 2x22µF$ )

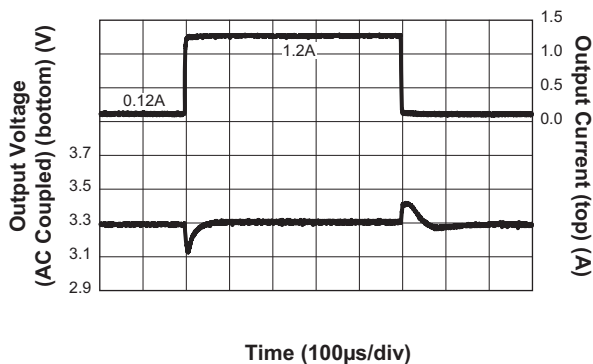

**Step-Down Converter Load Transient Response**  
( $I_{OUT} = 0.12A$  to  $1.2A$ ;  $V_{IN} = 12V$ ;  $V_{OUT} = 5V$ ;  $C_{OUT} = 2x22µF$ )

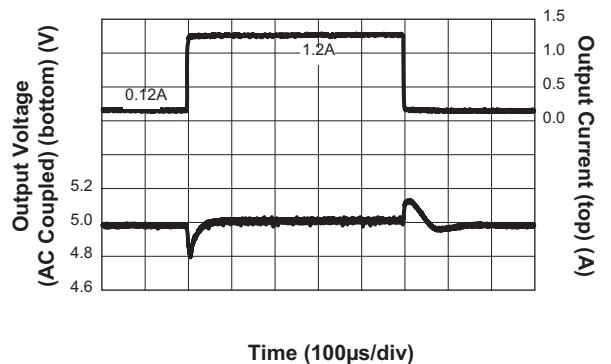

### Typical Characteristics

**Step-Down Converter Load Transient Response**  
 ( $I_{OUT} = 0.6A$  to  $1.2A$ ;  $V_{IN} = 12V$ ;  $V_{OUT} = 3.3V$ ;  $C_{OUT} = 2x22\mu F$ )

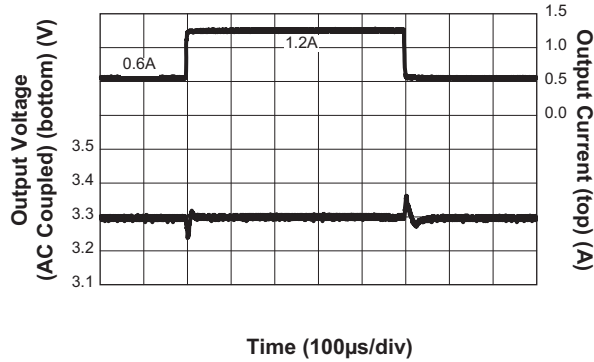

**Step-Down Converter Load Transient Response**  
 ( $I_{OUT} = 0.6A$  to  $1.2A$ ;  $V_{IN} = 12V$ ;  $V_{OUT} = 5V$ ;  $C_{OUT} = 2x22\mu F$ )

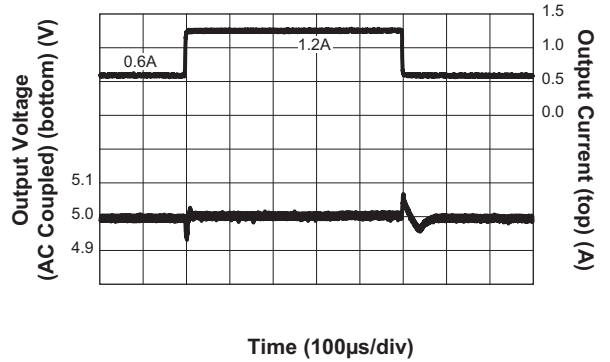

**Step-Down Converter Load Transient Response**  
 ( $I_{OUT} = 0.6A$  to  $1.2A$ ;  $V_{IN} = 12V$ ;  $V_{OUT} = 3.3V$ ;  $C_{OUT} = 2x22\mu F$ )

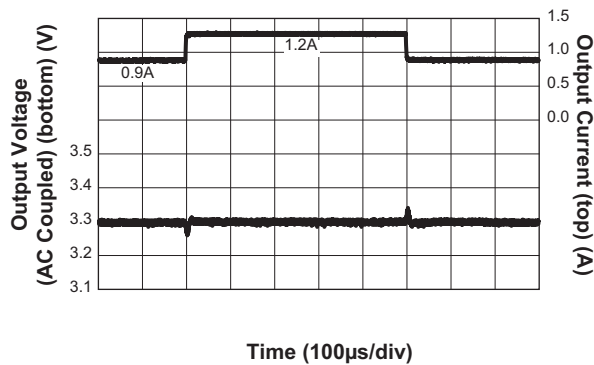

**Step-Down Converter Load Transient Response**  
 ( $I_{OUT} = 0.9A$  to  $1.2A$ ;  $V_{IN} = 12V$ ;  $V_{OUT} = 5V$ ;  $C_{OUT} = 2x22\mu F$ )

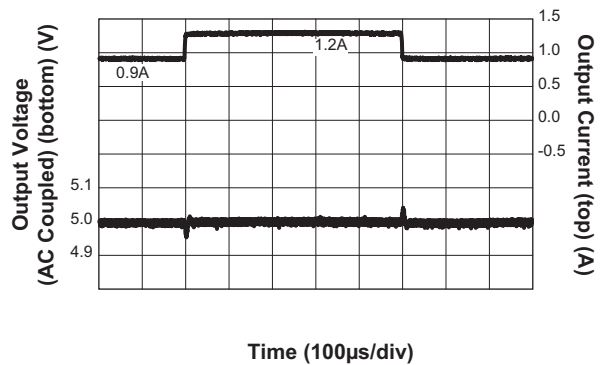

**Step-Down Converter Line Transient Response**  
 ( $V_{IN} = 6V$  to  $10V$ ;  $V_{OUT} = 3.3V$ ;  $I_{OUT} = 1.2A$ )

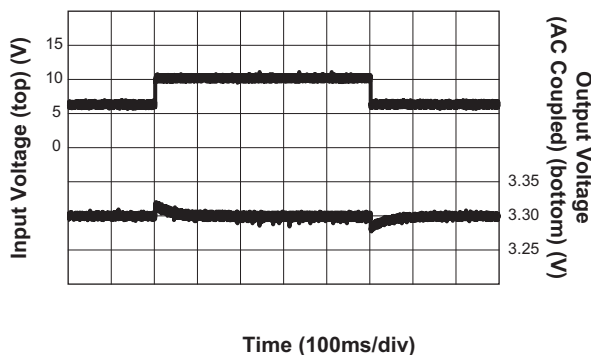

**Step-Down Converter Line Transient Response**  
 ( $V_{IN} = 6V$  to  $10V$ ;  $V_{OUT} = 5V$ ;  $I_{OUT} = 1.2A$ )

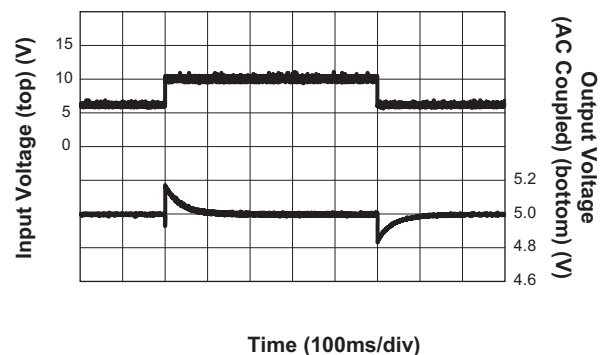

### Typical Characteristics

**Step-Down Converter Soft Start**  
 $(V_{IN} = 12V; V_{EN} = 10V; V_{OUT} = 3.3V; I_{OUT} = 1.2A)$

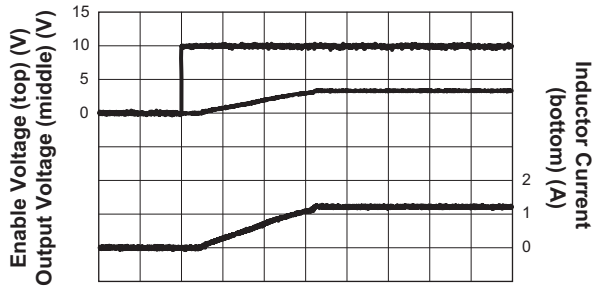

Time (500µs/div)

**Step-Down Converter Soft Start**  
 $(V_{IN} = 12V; V_{EN} = 10V; V_{OUT} = 5V; I_{OUT} = 1.2A)$

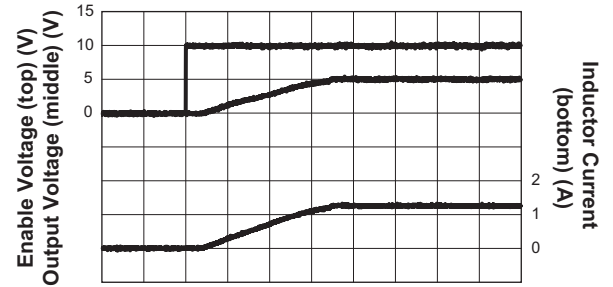

Time (500µs/div)

**Step-Down Converter Switching Frequency vs. Input Voltage**

$(V_{IN} = 6V \text{ to } 24V; V_{OUT} = 3.3V; I_{OUT} = 1.2A)$

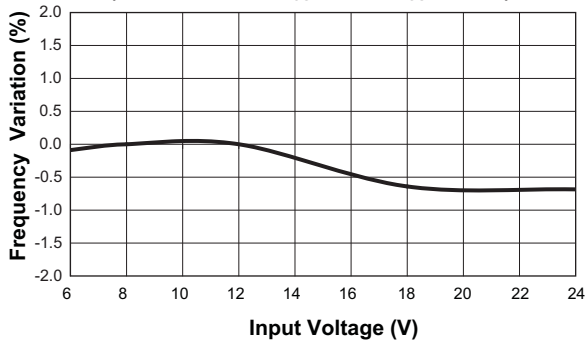

**Step-Down Converter Output Voltage Error vs. Temperature**

$(V_{IN} = 12V; V_{OUT} = 3.3V)$

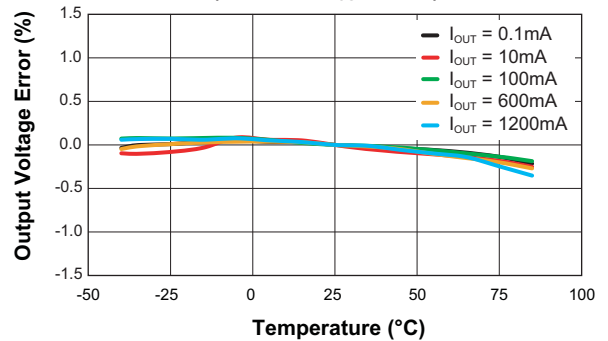

**Step-Down Converter Output Voltage Error vs. Temperature**

$(V_{IN} = 12V; V_{OUT} = 5V)$

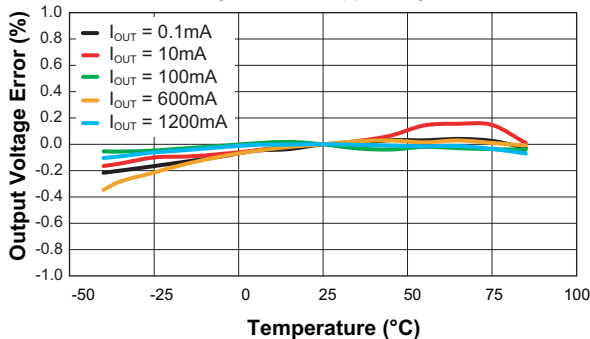

**No Load Step-Down Converter Input Current vs. Input Voltage**

$(V_{EN} = V_{IN})$

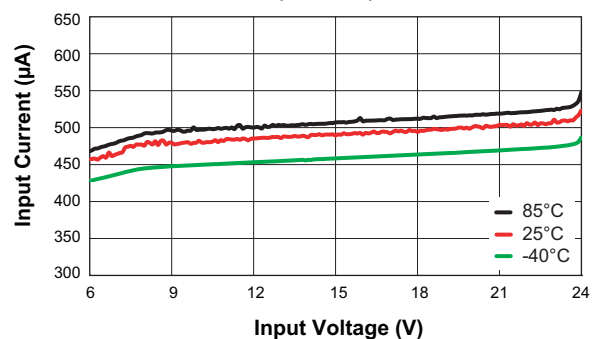



## Typical Characteristics

$V_{IH}$  and  $V_{IL}$  vs. Input Voltage

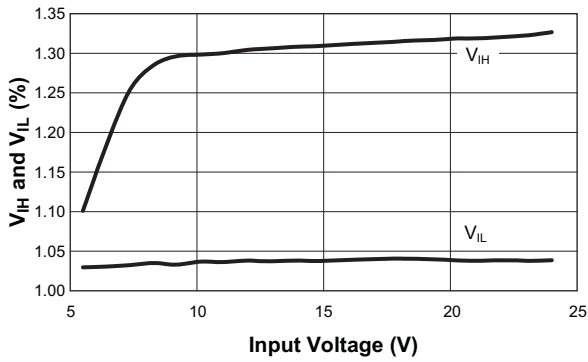



## Applications Information

The high voltage DC/DC step-down converter provides an output voltage from 1.5V to 5.5V. The integrated high-side n-channel MOSFET device provides up to 1.2A output current<sup>1</sup>. Input voltage range is 6.0V to 24.0V. The step-down converter utilizes constant frequency (PWM-mode) voltage mode control to achieve high operating efficiency while maintaining extremely low output noise across the operating range. High 490kHz (nominal) switching frequency allows small external filtering components, achieving minimum cost and solution size. External compensation allows the designer to optimize the transient response while achieving stability across the operating range.

## Output Voltage and Current

The output voltage is set using an external resistor divider as shown in Table 1. Minimum output voltage is 1.5V and maximum output voltage is 5.5V. Typical maximum duty cycle is 85%.

$V_{OUT}$ (V)	$R_5 = 6.04k\Omega$ $R_4$ (k $\Omega$ )
1.5	9.09
1.8	12.1
1.85	12.4
2.0	14.0
2.5	19.1
3.0	24.3
3.3	27.4
5.0	44.2

**Table 1: Feedback Resistor Values.**

Alternatively, the feedback resistor may be calculated using the following equation:

$$R_4 = \frac{(V_{OUT} - 0.6) \cdot R_5}{0.6}$$

$R_4$  is rounded to the nearest 1% resistor value.

## Buck Regulator Output Capacitor Selection

A 22 $\mu$ F ceramic output capacitor is required to filter the inductor current ripple and supply the load transient current for  $I_{OUT} = 1.2A$ . The 1206 package with 10V minimum voltage rating is recommended for the output

capacitors to maintain a minimum capacitance drop with DC bias.

## Output Inductor Selection

The step-down converter utilizes constant frequency (PWM-mode) voltage mode control. A 4.7 $\mu$ H inductor value is selected to maintain the desired output current ripple and minimize the converter's response time to load transients. The peak switch current should not exceed the inductor saturation current, the MOSFET or the external Schottky rectifier peak current ratings.

## Rectifier Selection

When the high-side switch is on, the input voltage will be applied to the cathode of the Schottky diode. The rectifier's rated reverse breakdown voltage must be chosen at least equal to the maximum input voltage of the step-down regulator.

When the high-side switch is off, the current will flow from the power ground to the output through the Schottky diode and the inductor. The power dissipation of the Schottky diode during the time-off can be determined by the following equation:

$$P_D = I_{OUT} \cdot V_D \cdot \left(1 - \frac{V_{OUT}}{V_{IN}}\right)$$

Where  $V_D$  is the voltage drop across the Schottky diode.

## Input Capacitor Selection

For low cost applications, a 100 $\mu$ F/25V electrolytic capacitor is selected to control the voltage overshoot across the high side MOSFET. A small ceramic capacitor with voltage rating at least 1.05 times greater than the maximum input voltage is connected as close as possible to the input pin (Pin 14) for high frequency decoupling.

## Feedback and Compensation Networks

The transfer function of the Error Amplifier is dominated by the DC Gain and the  $L C_{OUT}$  output filter of the regulator. This output filter and its equivalent series resistor (ESR) create a double pole at  $F_{LC}$  and a zero at  $F_{ESR}$  in the following equations:

$$\text{Eq. 1: } F_{LC} = \frac{1}{2 \cdot \pi \cdot \sqrt{L \cdot C_{OUT}}}$$

1. Output current capability may vary and is dependent on package selection, maximum ambient temperature, airflow and PCB heatsinking.

$$\text{Eq. 2: } F_{\text{ESR}} = \frac{1}{2 \cdot \pi \cdot \text{ESR} \cdot C_{\text{OUT}}}$$

The feedback and compensation networks provide a closed loop transfer function with the highest 0dB crossing frequency and adequate phase margin for system stability. Equations 3, 4, 5 and 6 relate the compensation network's poles and zeros to the components R2, R3, R4, C5, C6, and C7:

$$\text{Eq. 3: } F_{z1} = \frac{1}{2 \cdot \pi \cdot R_2 \cdot C_5}$$

$$\text{Eq. 4: } F_{z2} = \frac{1}{2 \cdot \pi \cdot (R_7 + R_4) \cdot C_7}$$

$$\text{Eq. 5: } F_{p1} = \frac{1}{2 \cdot \pi \cdot R_2 \cdot \left( \frac{C_5 \cdot C_6}{C_5 + C_6} \right)}$$

$$\text{Eq. 6: } F_{p2} = \frac{1}{2 \cdot \pi \cdot R_7 \cdot C_7}$$

Components of the feedback, feed forward, compensation, and current limit networks need to be adjusted to maintain system stability for different input and output voltage applications as shown in Table 2.

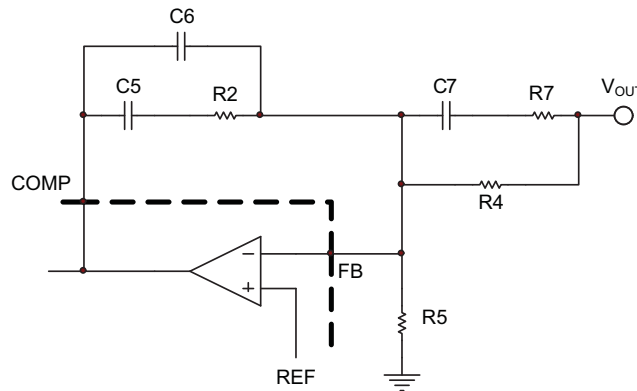

Figure 1: AAT1184 Feedback and Compensation Networks for Type III Voltage-Mode Control Loop.

Network	Components	V <sub>OUT</sub> = 3.3V	V <sub>OUT</sub> = 5.0V
Feedback	R4	27.4kΩ	44.2kΩ
	R5	6.02kΩ	6.02kΩ
Feed-forward	C7	330pF	330pF
	R7	499Ω	499Ω
Compensation	C5	470pF	220pF
	C6	56pF	56pF
	R2	24.3kΩ	24.3kΩ
Current Limit	C4	68nF	68nF
	R1	2.32kΩ	2.32kΩ
	R3	0kΩ	0kΩ
	R6	Open	Open
	R8	Open	Open

Table 2: AAT1184 Feedback and Compensation Network Components for V<sub>OUT</sub> = 3.3V and V<sub>OUT</sub> = 5.0V.

### Thermal Protection

The AAT1184 has an internal thermal protection circuit which will turn on when the device die temperature exceeds 135°C. The internal thermal protection circuit will actively turn off the high side regulator output device to prevent the possibility of over temperature damage. The Buck regulator output will remain in a shutdown state until the internal die temperature falls back below the 135°C trip point. The combination and interaction between the short circuit and thermal protection systems allows the Buck regulator to withstand indefinite short-circuit conditions without sustaining permanent damage.

### Thermal Calculations

There are two types of losses associated with the AAT1184 step-down converter: switching losses, conduction losses, and quiescent current losses. Conduction losses are associated with the  $R_{DS(ON)}$  characteristics of the power output switching devices. Switching losses are dominated by the gate charge of the power output switching devices. At full load, assuming continuous conduction mode (CCM), a simplified form of the synchronous step-down converter losses is given by:

$$P_{TOTAL} = \frac{I_{OUT}^2 \cdot (R_{DS(ON)H} \cdot V_{OUT} + R_{DS(ON)L} \cdot [V_{IN} - V_{OUT}])}{V_{IN}} + (t_{SW} \cdot F_S \cdot I_{OUT} + I_Q) \cdot V_{IN}$$

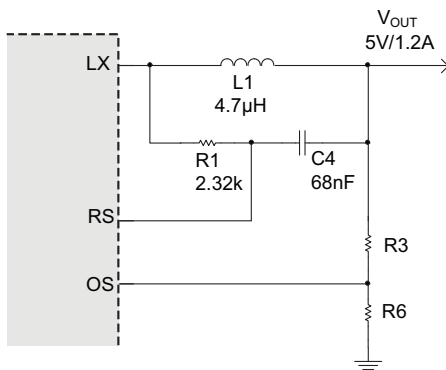

**Figure 2: Resistor Network to Adjust the Current Limit Less than the Pre-Set Over-Current Threshold (Add R6, R7).**

$I_Q$  is the step-down converter current. The term  $t_{SW}$  is used to estimate the full load step-down converter switching losses.

For asynchronous Step-Down converter, the power dissipation is only in the internal high side MOSFET during the on time. When the switch is off, the power dissipates on the external Schottky diode. Total package losses for AAT1184 reduce to the following equation:

$$P_{TOTAL} = I_{OUT}^2 \cdot R_{DS(ON)H} \cdot D + (t_{SW} \cdot F_S \cdot I_{OUT} + I_Q) \cdot V_{IN}$$

where  $D = \frac{V_{OUT}}{V_{IN}}$  is the duty cycle.

Since  $R_{DS(ON)}$ , quiescent current, and switching losses all vary with input voltage, the total losses should be investigated over the complete input voltage range.

Given the total losses, the maximum junction temperature can be derived from the  $\theta_{JA}$  for the TSOPJW-12 package, which is 140°C/W.

$$T_{J(MAX)} = P_{TOTAL} \cdot \theta_{JA} + T_{AMB}$$

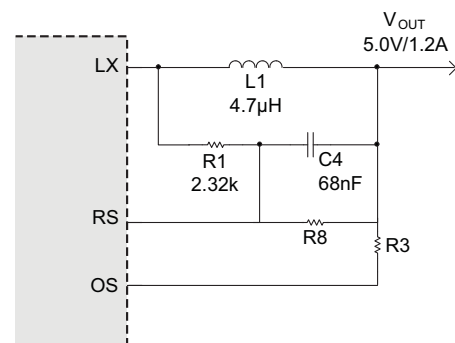

**Figure 3: Resistor Network to Adjust the Current Limit Greater than the Pre-Set Over-Current Level (Add R6, R8).**

**Over-Current Protection**

The controller provides true-load DC output current sensing which protects the load and limits component stresses. The output current is sensed through the DC resistance in the output inductor (DCR). The controller reduces the operating frequency when an over-current condition is detected; limiting stresses and preventing inductor saturation. This allows the smallest possible inductor for a given output load. A small resistor divider may be necessary to adjust the over-current threshold and compensate for variation in inductor DCR.

The preset current limit threshold is triggered when the differential voltage from RS to OS exceeds 100mV (nominal).

**Layout Considerations**

The suggested PCB layout for the AAT1184 is shown in Figures 5 and 6. The following guidelines should be used to help ensure a proper layout.

1. The power input capacitors (C1 and C12) should be connected as close as possible to high voltage input pin (IN) and power ground.
2. C2, L1, D2, and C8 should be placed as close as possible to minimize any parasitic inductance in the switched current path which generates a large voltage spike during the switching interval. The connection of inductor to switching node should be as short as possible.
3. The feedback trace or FB pin should be separated from any power trace and connected as close as possible to the load point. Sensing along a high-current load trace will degrade DC load regulation.
4. The resistance of the trace from the load returns to PGND should be kept to a minimum. This will help to minimize any error in DC regulation due to differences in the potential of the internal signal ground and the power ground.
5. Connect unused signal pins to ground to avoid unwanted noise coupling.
6. The critical small signal components include feedback components, and compensation components should be placed close to the FB and COMP pins. The feedback resistors should be located as close as possible to the FB pin with its ground tied directly to the signal ground plane which is separated from power ground plane.
7. C4 should be connected close to the RS and OS pins, while R1 should be connected directly to the output pin of the inductor. For the best current limit performance, C4 and R1 should be placed on the bottom layer to avoid noise coupling from the inductor.

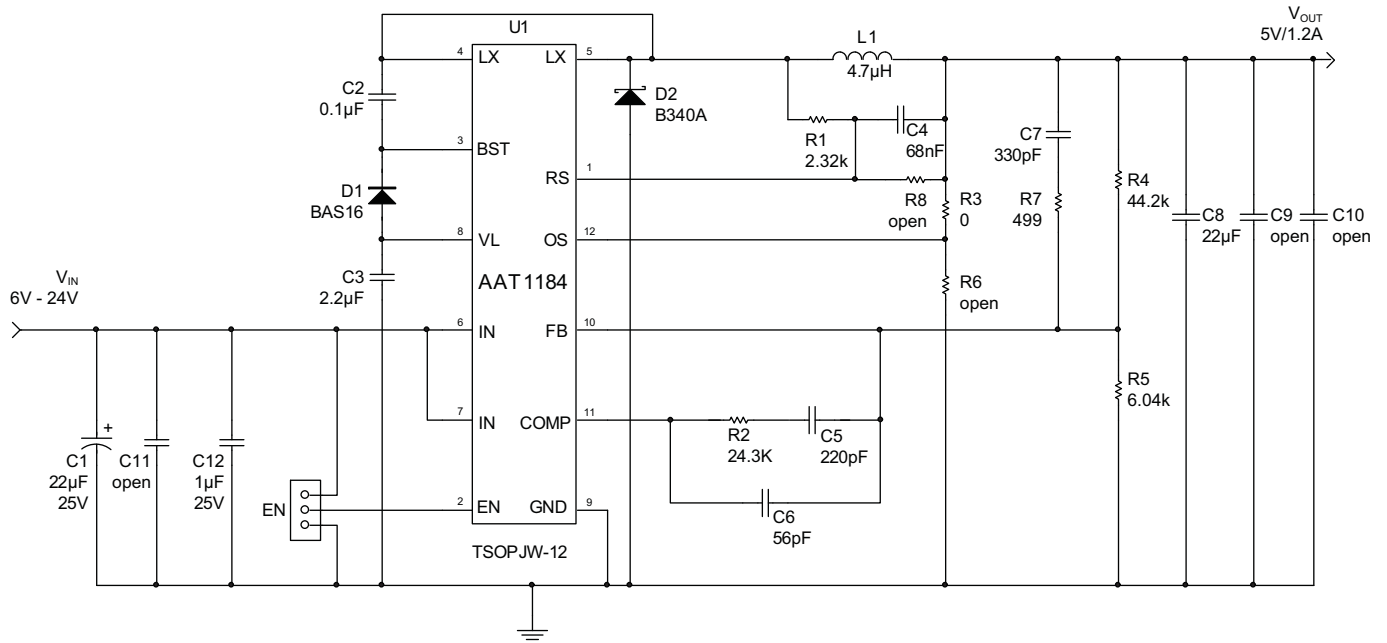

- U1 AAT1189 Analogic Technologies, Hi-Voltage Buck, TSOPJW-12
- C1 Cap, MLC, 100µF/25V, Electrolytic cap
- C2 Cap, MLC, 0.1µF/6.3V, 0603
- C3 Cap, MLC, 2.2µF/6.3V, 0602
- C4,C5,C6,C7 Cap, MLC, misc, 0603
- C8 Cap, MLC, 22µF/6.3V, 1206
- C12 Cap, MLC, 1µF/25V, 1206
- D1 BAS16, Generic, Rectifier, 0.2A/85V, Ultrafast, SOT-23
- D2 B340A, Generic, Schottky Rectifier, 3A/40V, SMA
- L1 SLF7045T-4R7M2R0-PF, TDK, 4.7µH, I<sub>SAT</sub> = 2A, DCR = 30mΩ
- R1-R6 Carbon film resistor, 0402

Figure 4: AAT1184ITP Evaluation Board Schematic.

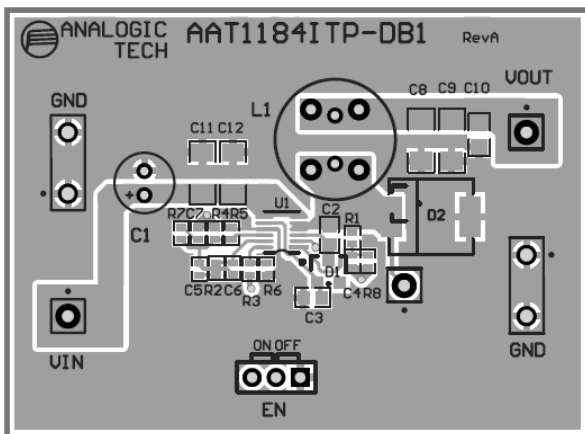

Figure 5: AAT1184ITP Evaluation Board Top Layer.

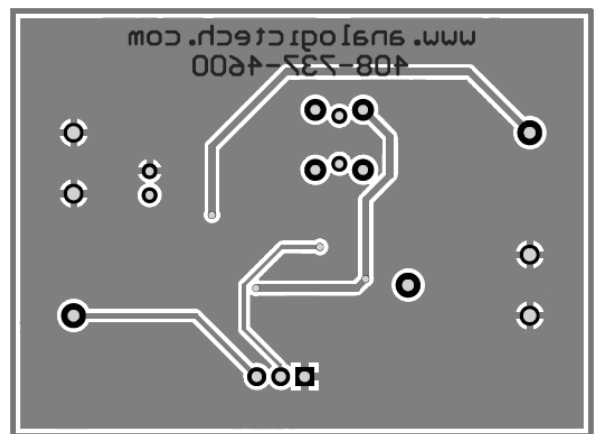

Figure 6: AAT1184ITP Evaluation Board Bottom Layer.

## AAT1184 Design Example

### Specifications

$V_{OUT} = 5.0V @ 1.2A$ , Pulsed Load  $\Delta I_{LOAD} = 1.2A$   
 $V_{IN} = 12V$   
 $F_S = 490kHz$   
 $T_{AMB} = 85^\circ C$  in TSOPJW-12 Package

### Output Inductor

For TDK inductor SLF7045T-4R7M2R0-PF,  $4.7\mu H$ , DCR =  $30m\Omega$  max.

$$\Delta I = \frac{V_{OUT}}{L_1 \cdot F_S} \cdot \left(1 - \frac{V_{OUT}}{V_{IN}}\right) = \frac{5V}{4.7\mu H \cdot 490kHz} \cdot \left(1 - \frac{5V}{12V}\right) = 1.2A$$

$$I_{PK} = I_{OUT} + \frac{\Delta I}{2} = 1.2A + 0.6A = 1.8A$$

$$P_{L1} = I_{OUT}^2 \cdot DCR = 1.8A^2 \cdot 11.7m\Omega = 37.9mW$$

### Output Capacitor

$V_{DROOP} = 0.33V$  (10% Output Voltage)

$$C_{OUT} = \frac{3 \cdot \Delta I_{LOAD}}{V_{DROOP} \cdot F_S} = \frac{3 \cdot 1.2A}{0.33V \cdot 490kHz} = 22.3\mu F; \text{ use } 22\mu F$$

$$I_{RMS(MAX)} = \frac{1}{2 \cdot \sqrt{3}} \cdot \frac{V_{OUT} \cdot (V_{IN(MAX)} - V_{OUT1})}{L \cdot F_S \cdot V_{IN1(MAX)}} = \frac{1}{2 \cdot \sqrt{3}} \cdot \frac{5.0V \cdot (24V - 5.0V)}{4.7\mu H \cdot 490kHz \cdot 24V} = 496mA_{RMS}$$

$$P_{RMS} = ESR \cdot I_{RMS}^2 = 5m\Omega \cdot (496mA)^2 = 1.2mW$$

### Input Capacitor

Input Ripple  $V_{PP} = 25mV$

$$C_{IN} = \frac{1}{\left(\frac{V_{PP}}{I_{OUT}} - ESR\right) \cdot 4 \cdot F_S} = \frac{1}{\left(\frac{25mV}{1.2A} - 5m\Omega\right) \cdot 4 \cdot 490kHz} = 32\mu F$$

For low cost applications, a  $100\mu F/25V$  electrolytic capacitor in parallel with a  $1\mu F/25V$  ceramic capacitor is used to reduce the ESR.

$$I_{RMS} = \frac{I_{OUT}}{2} = 0.6A$$

$$P = ESR \cdot (I_{RMS})^2 = 5m\Omega \cdot (0.6A)^2 = 1.8mW$$



**Current Limit**

Over-Current Offset Voltage:  $V_{\text{OCP}} = 100\text{mV}$

Total trace parasitic resistor and inductor DCR is  $30\text{m}\Omega$

$I_{\text{LIMIT}} = 3\text{A}$

$$I_{\text{PRESET}} = \frac{V_{\text{OCP}}}{\text{DCR}} = \frac{100\text{mV}}{30\text{m}\Omega} = 3.3\text{A}$$

**AAT1184 Losses**

All values assume an  $85^\circ\text{C}$  ambient temperature and thermal resistance of  $50^\circ\text{C}/\text{W}$  in the TSOPJW-12 package.

$$P_{\text{TOTAL}} = I_{\text{OUT}}^2 \cdot R_{\text{DS(ON)H}} \cdot D + (t_{\text{SW}} \cdot F_{\text{S}} \cdot I_{\text{OUT}} + I_{\text{Q}}) \cdot V_{\text{IN}}$$

$$P_{\text{TOTAL}} = \frac{1.2\text{A}^2 \cdot 70\text{m}\Omega \cdot 5\text{V}}{12\text{V}} + (5\text{ns} \cdot 490\text{kHz} \cdot 1.2\text{A} + 70\mu\text{A}) \cdot 12\text{V}$$

$$P_{\text{TOTAL}} = 78\text{mW}$$

$$T_{\text{J(MAX)}} = T_{\text{AMB}} + \Theta_{\text{JA}} \cdot P_{\text{LOSS}} = 85^\circ\text{C} + (140^\circ\text{C}/\text{W}) \cdot 78\text{mW} = 96^\circ\text{C}$$

## Ordering Information

Package	Voltage	Marking <sup>1</sup>	Part Number (Tape and Reel) <sup>2</sup>
TSOPJW-12	0.6	3QXY	AAT1184ITP-0.6-T1



All AnalogicTech products are offered in Pb-free packaging. The term “Pb-free” means semiconductor products that are in compliance with current RoHS standards, including the requirement that lead not exceed 0.1% by weight in homogeneous materials. For more information, please visit our website at <http://www.analogictech.com/about/quality.aspx>.

## Package Information

TSOPJW-12

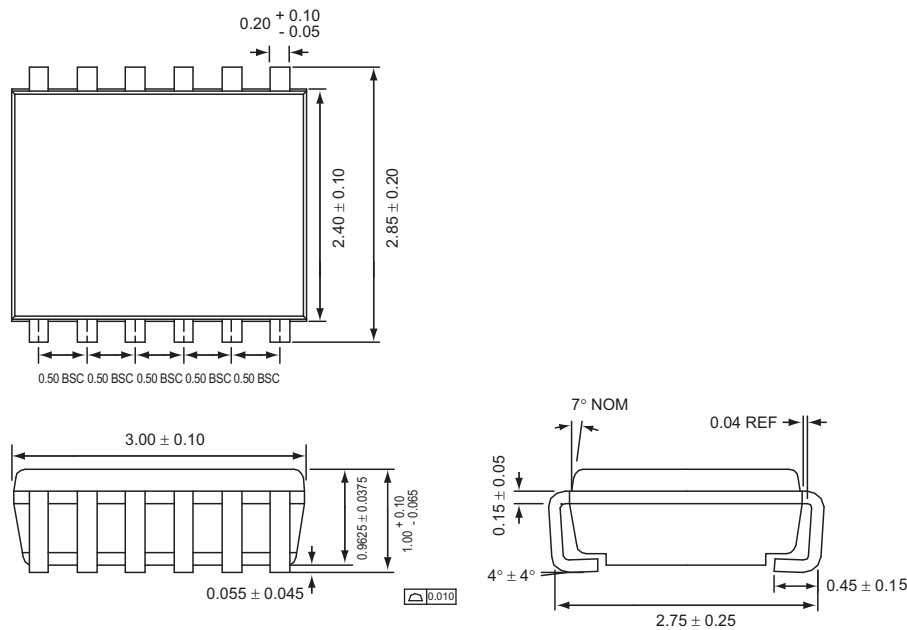

All dimensions in millimeters.

1. XYY = assembly and date code.  
 2. Sample stock is generally held on part numbers listed in **BOLD**.

**SwitchReg™****High Voltage Step-Down Regulator**

**Advanced Analogic Technologies, Inc.**  
3230 Scott Boulevard, Santa Clara, CA 95054  
Phone (408) 737-4600  
Fax (408) 737-4611



© Advanced Analogic Technologies, Inc.  
AnalogicTech cannot assume responsibility for use of any circuitry other than circuitry entirely embodied in an AnalogicTech product. No circuit patent licenses, copyrights, mask work rights, or other intellectual property rights are implied. AnalogicTech reserves the right to make changes to their products or specifications or to discontinue any product or service without notice. Except as provided in AnalogicTech's terms and conditions of sale, AnalogicTech assumes no liability whatsoever, and AnalogicTech disclaims any express or implied warranty relating to the sale and/or use of AnalogicTech products including liability or warranties relating to fitness for a particular purpose, merchantability, or infringement of any patent, copyright or other intellectual property right. In order to minimize risks associated with the customer's applications, adequate design and operating safeguards must be provided by the customer to minimize inherent or procedural hazards. Testing and other quality control techniques are utilized to the extent AnalogicTech deems necessary to support this warranty. Specific testing of all parameters of each device is not necessarily performed. AnalogicTech and the AnalogicTech logo are trademarks of Advanced Analogic Technologies Incorporated. All other brand and product names appearing in this document are registered trademarks or trademarks of their respective holders.