

BRIGHT LED ELECTRONICS CORP.

LED DISPLAY SPECIFICATION

●COMMODITY : 0.33"(8.40mm) FOUR DIGIT LED DISPLAY

●DEVICE NUMBER : BQ-M305RD

VERSION : 1.0 / 2002.04.16

●ELECTRICAL AND OPTICAL CHARACTERISTICS (Ta=25°C)

Chip		Absolute Maximum Rating				Electro-optical Data (At 10mA)			Surface Color	Segment Color
Emitted Color	Peak Wave Length $\lambda P(\text{nm})$	$\Delta \lambda$ (nm)	Pd (mW)	If (mA)	Peak If(mA)	Vf(V)		Iv Typ. (mcd)		
						Typ.	Max.			
Bright	700	90	40	15	50	2.2	2.5	1.2	Black	White

●ABSOLUTE MAXIMUM RATINGS (Ta=25°C)

Reverse Voltage 5V
 Reverse Current (Vr=5V) 50 μ A
 Operating Temperature Range -40°C ~ 80°C
 Storage Temperature Range -40°C ~ 85°C
 Lead Soldering Temperature (1/16" From Body).....260°C For 5 Seconds

PACKAGE DIMENSIONS:

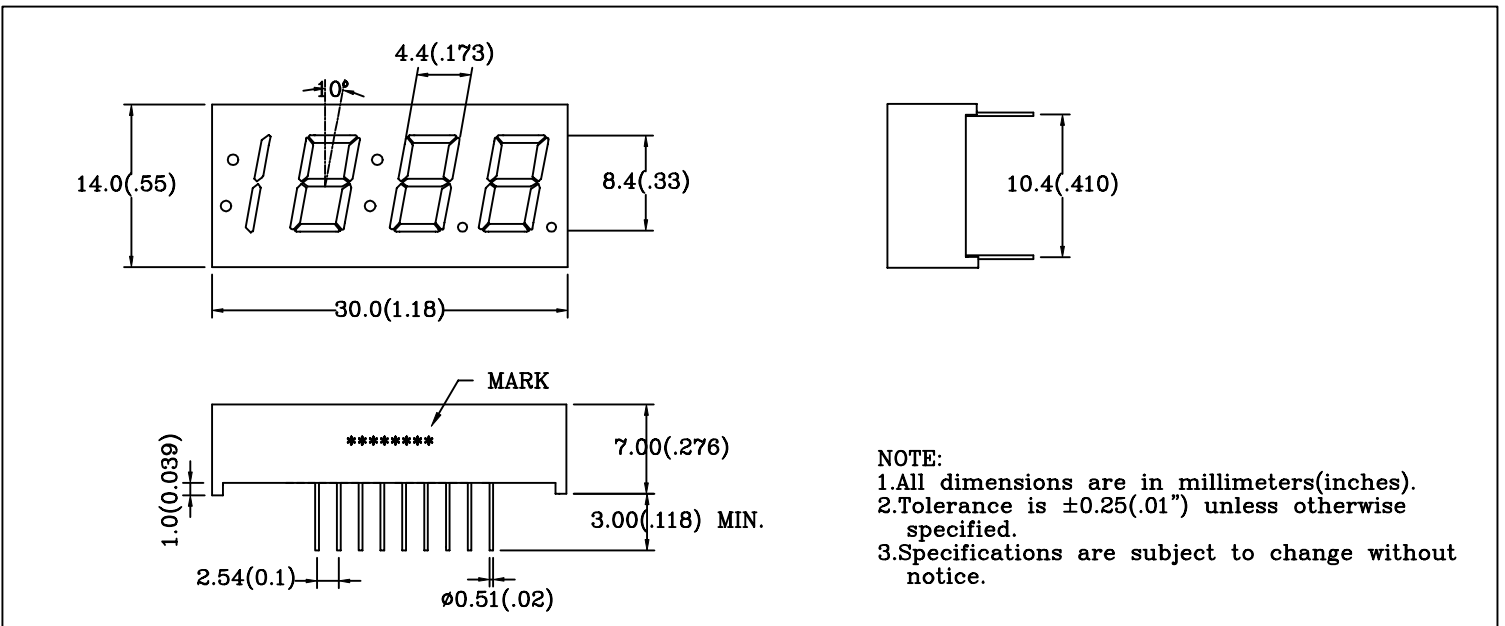

PIN FUNCTIONS:

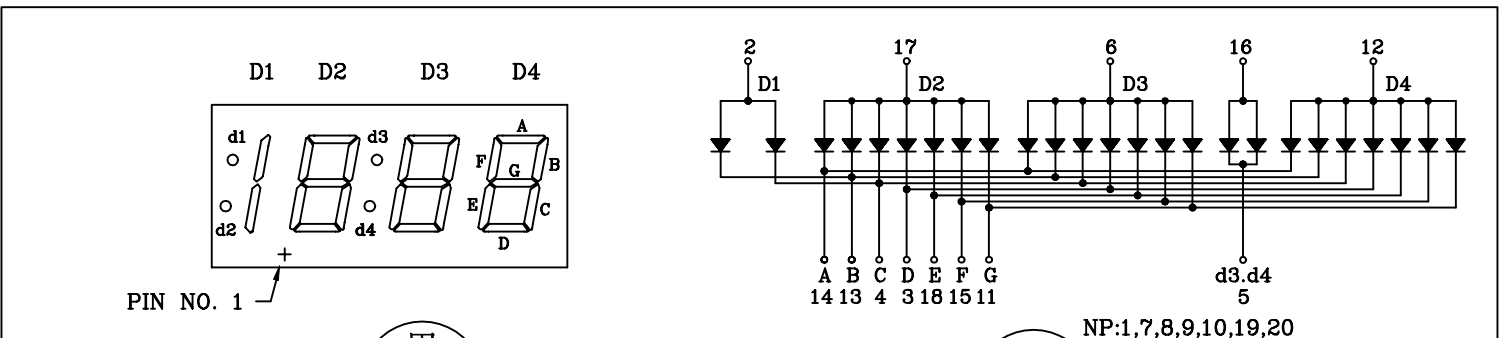

RELEASED:

田
2002.04.16
洪倫

ENGINEER:

余
2002.04.16
愛萍

BRIGHT LED ELECTRONICS CORP.

TYPICAL CHARACTERISTICS

DEVICE NUMBER: BQ-M305RD

SPECTRAL DISTRIBUTION

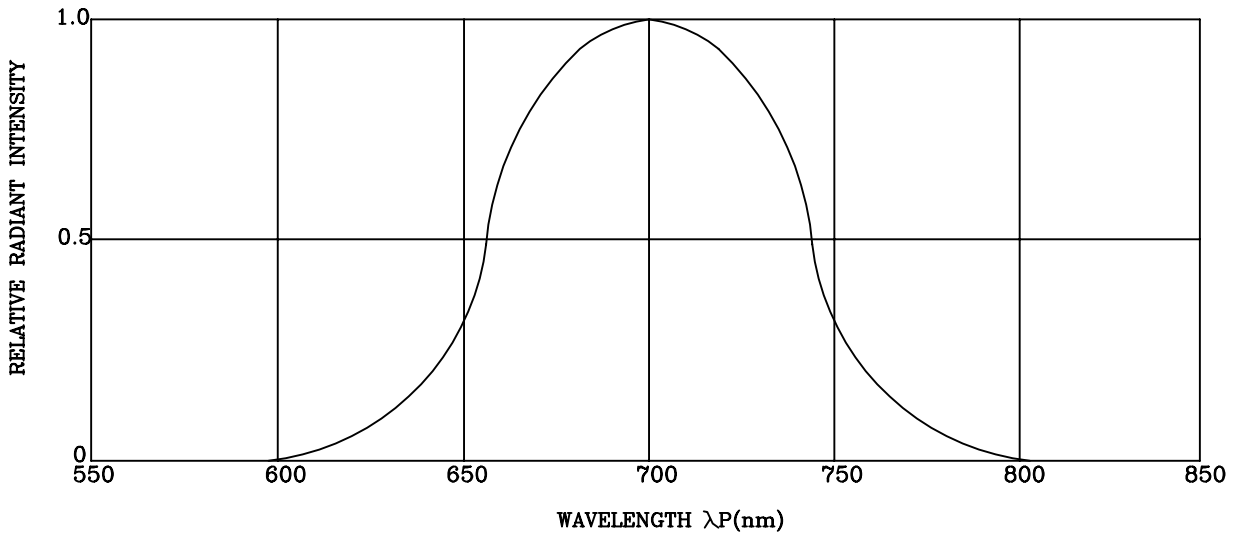

FORWARD CURRENT VS. FORWARD VOLTAGE

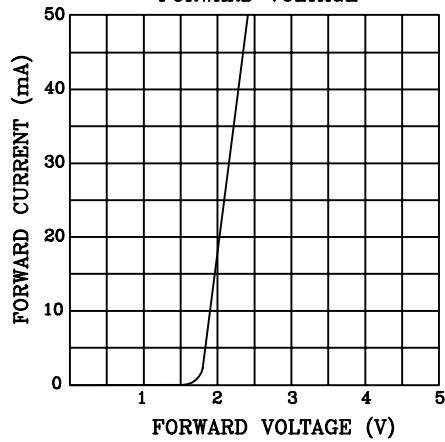

RELATIVE LUMINOUS INTENSITY VS. AMBIENT TEMPERATURE

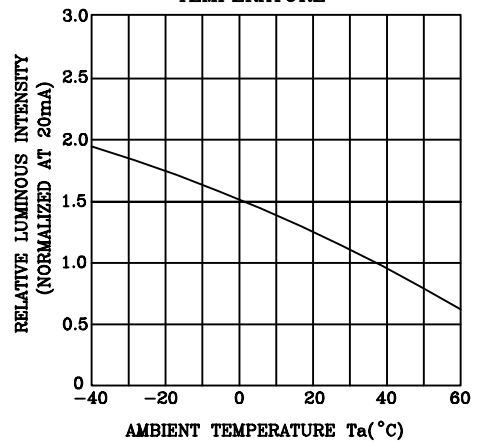

RELATIVE LUMINOUS INTENSITY VS. FORWARD CURRENT

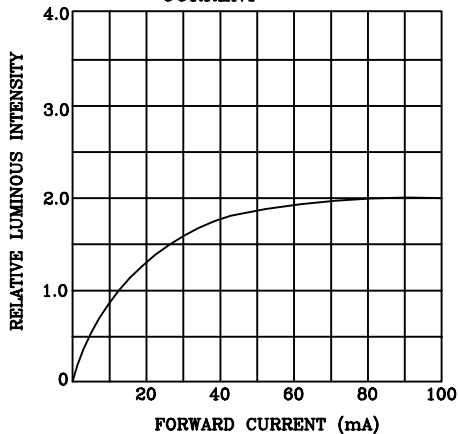

FORWARD CURRENT DERATING CURVE

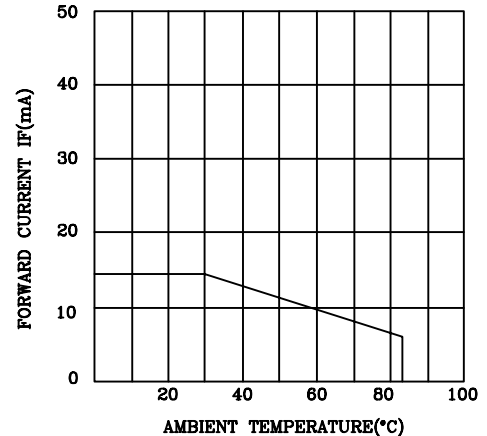

RELIABILITY TEST

DEVICE NO.: BQ-M305RD

Classification	Test Item	Reference Standard	Test Conditions	Result
Endurance Test	Operation Life	MIL-STD-750:1026 MIL-STD-883:1005 JIS C 7021 :B-1	Connect with a power $I_f=25\text{mA}$ T_a =Under room temperature Test time=1,000hrs(-24hrs,+72hrs)	0/10
	High Temperature High Humidity Storage	MIL-STD-202:103B JIS C 7021 :B-11	$T_a=65^\circ\text{C}\pm 5^\circ\text{C}$ RH=90%-95% Test time=240hrs \pm 2hrs	0/10
	High Temperature High Humidity Reverse Bias		$T_a=65^\circ\text{C}\pm 5^\circ\text{C}$ RH=90%-95% Test time=500hrs(-24hrs,+48hrs)	0/10
	High Temperature Storage	MIL-STD-883:1008 JIS C 7021 :B-10	High $T_a=85^\circ\text{C}\pm 5^\circ\text{C}$ Test time=1,000hrs(-24hrs,+72hrs)	0/10
	Low Temperature Storage	JIS-C-7021 :B-12	Low $T_a=-35^\circ\text{C}\pm 5^\circ\text{C}$ Test time=1,000hrs(-24hrs,+72hrs)	0/10
Environmental Test	Temperature Cycling	MIL-STD-202:107D MIL-STD-750:1051 MIL-STD-883:1010 JIS C 7021 :A-4	$-35^\circ\text{C} \sim 25^\circ\text{C} \sim 85^\circ\text{C} \sim 25^\circ\text{C}$ 30min 5min 30min 5min Test Time=10cycle	0/10
	Thermal Shock	MIL-STD-202:107D MIL-STD-750:1051 MIL-STD-883:1011	$85^\circ\text{C}\pm 5^\circ\text{C} \sim -35^\circ\text{C}\pm 5^\circ\text{C}$ 10min 10min Test Time=10cycle	0/10
	Solder Resistance	MIL-STD-202:201A MIL-STD-750:2031 JIS C 7021 :A-1	$T_{\text{sol}}=260\pm 5^\circ\text{C}$ Dwell Time=10 \pm 1sec.	0/10
	Solderability	MIL-STD-202:208D MIL-STD-750:2026 MIL-STD-883:2003 JIS C 7021 :A-2	$T_{\text{sol}}=230\pm 5^\circ\text{C}$ Dwell Time=5 \pm 1sec.	0/10

JUDGMENT CRITERIA OF FAILURE FOR THE RELIABILITY

Measuring items	Symbol	Measuring conditions	Judgement criteria for failure
Forward voltage	VF	$I_F=10\text{mA}$	Over $U_x1.2$
Reverse current	IR	$V_R=5\text{V}$	Over U_x2
Luminous intensity	IV	$I_F=10\text{mA}$	Below $S_x0.5$

Note: 1.U means the upper limit of specified characteristics. S means initial value.

2.Measurment shall be taken between 2 hours and after the test pieces have been returned to normal ambient conditions after completion of each test.