

Power MOSFET

PRODUCT SUMMARY	
V_{DS} (V)	600
$R_{DS(on)}$ (Ω)	$V_{GS} = 10\text{ V}$ 0.385
Q_g (Max.) (nC)	100
Q_{gs} (nC)	30
Q_{gd} (nC)	46
Configuration	Single

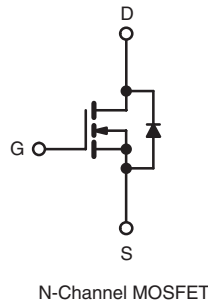
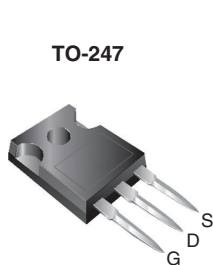

FEATURES

- Superfast Body Diode Eliminates the Need for External Diodes in ZVS Applications
- Lower Gate Charge Results in Simple Drive Requirements
- Enhanced dV/dt Capabilities Offer Improved Ruggedness
- Higher Gate Voltage Threshold Offers Improved Noise Immunity
- Lead (Pb)-free Available



RoHS*
COMPLIANT

APPLICATIONS

- Zero Voltage Switching SMPS
- Telecom and Server Power Supplies
- Uninterruptible Power Supplies
- Motor Control Applications

ORDERING INFORMATION	
Package	TO-247
Lead (Pb)-free	IRFP15N60LPbF
	SiHFP15N60L-E3
SnPb	IRFP15N60L
	SiHFP15N60L

ABSOLUTE MAXIMUM RATINGS $T_C = 25\text{ }^\circ\text{C}$, unless otherwise noted			
PARAMETER	SYMBOL	LIMIT	UNIT
Drain-Source Voltage	V_{DS}	600	V
Gate-Source Voltage	V_{GS}	± 30	
Continuous Drain Current	V_{GS} at 10 V	$T_C = 25\text{ }^\circ\text{C}$	15
		$T_C = 100\text{ }^\circ\text{C}$	9.7
Pulsed Drain Current ^a	I_{DM}	60	A
Linear Derating Factor		2.3	W/ $^\circ\text{C}$
Single Pulse Avalanche Energy ^b	E_{AS}	320	mJ
Repetitive Avalanche Current ^a	I_{AR}	15	A
Repetitive Avalanche Energy ^a	E_{AR}	28	mJ
Maximum Power Dissipation	$T_C = 25\text{ }^\circ\text{C}$	P_D	280
Peak Diode Recovery dV/dt^c	dV/dt	10	V/ns
Operating Junction and Storage Temperature Range	T_J, T_{stg}	- 55 to + 150	$^\circ\text{C}$
Soldering Recommendations (Peak Temperature)	for 10 s	300 ^d	
Mounting Torque	6-32 or M3 screw	10	
		1.1	N · m

Notes

- Repetitive rating; pulse width limited by maximum junction temperature (see fig. 11).
- Starting $T_J = 25\text{ }^\circ\text{C}$, $L = 2.9\text{ mH}$, $R_G = 25\text{ }\Omega$, $I_{AS} = 15\text{ A}$, $dV/dt = 10\text{ V/ns}$ (see fig. 12a).
- $I_{SD} \leq 15\text{ A}$, $dI/dt \leq 340\text{ A}/\mu\text{s}$, $V_{DD} \leq V_{DS}$, $T_J \leq 150\text{ }^\circ\text{C}$.
- 1.6 mm from case.

* Pb containing terminations are not RoHS compliant, exemptions may apply

THERMAL RESISTANCE RATINGS				
PARAMETER	SYMBOL	TYP.	MAX.	UNIT
Maximum Junction-to-Ambient	R_{thJA}	-	40	°C/W
Case-to-Sink, Flat, Greased Surface	R_{thCS}	0.24	-	
Maximum Junction-to-Case (Drain)	R_{thJC}	-	0.44	

SPECIFICATIONS $T_J = 25\text{ }^\circ\text{C}$, unless otherwise noted

PARAMETER	SYMBOL	TEST CONDITIONS	MIN.	TYP.	MAX.	UNIT
Static						
Drain-Source Breakdown Voltage	V_{DS}	$V_{GS} = 0\text{ V}$, $I_D = 250\text{ }\mu\text{A}$	600	-	-	V
V_{DS} Temperature Coefficient	$\Delta V_{DS}/T_J$	Reference to $25\text{ }^\circ\text{C}$, $I_D = 1\text{ mA}$	-	0.39	-	V/°C
Gate-Source Threshold Voltage	$V_{GS(th)}$	$V_{DS} = V_{GS}$, $I_D = 250\text{ }\mu\text{A}$	3.0	-	5.0	V
Gate-Source Leakage	I_{GSS}	$V_{GS} = \pm 30\text{ V}$	-	-	± 100	nA
Zero Gate Voltage Drain Current	I_{DSS}	$V_{DS} = 600\text{ V}$, $V_{GS} = 0\text{ V}$	-	-	50	μA
		$V_{DS} = 480\text{ V}$, $V_{GS} = 0\text{ V}$, $T_J = 125\text{ }^\circ\text{C}$	-	-	2.0	mA
Drain-Source On-State Resistance	$R_{DS(on)}$	$V_{GS} = 10\text{ V}$ $I_D = 9.0\text{ A}^b$	-	0.385	0.460	Ω
Forward Transconductance	g_{fs}	$V_{DS} = 50\text{ V}$, $I_D = 9.0\text{ A}$	8.3	-	-	S
Dynamic						
Input Capacitance	C_{iss}	$V_{GS} = 0\text{ V}$, $V_{DS} = 25\text{ V}$, $f = 1.0\text{ MHz}$, see fig. 5	-	2720	-	pF
Output Capacitance	C_{oss}		-	260	-	
Reverse Transfer Capacitance	C_{rss}		-	20	-	
Effective Output Capacitance	$C_{oss\text{ eff.}}$	$V_{GS} = 0\text{ V}$, $V_{DS} = 0\text{ V to } 480\text{ V}^c$	-	120	-	pF
Effective Output Capacitance (Energy Related)	$C_{oss\text{ eff. (ER)}}$		-	100	-	
Total Gate Charge	Q_g	$V_{GS} = 10\text{ V}$ $I_D = 15\text{ A}$, $V_{DS} = 480\text{ V}$, see fig. 7 and 15 ^b	-	-	100	nC
Gate-Source Charge	Q_{gs}		-	-	30	
Gate-Drain Charge	Q_{gd}		-	-	46	
Turn-On Delay Time	$t_{d(on)}$	$V_{DD} = 300\text{ V}$, $I_D = 15\text{ A}$, $R_G = 1.8\text{ }\Omega$, $V_{GS} = 10\text{ V}$, see fig. 11a and 11b ^b	-	20	-	ns
Rise Time	t_r		-	44	-	
Turn-Off Delay Time	$t_{d(off)}$		-	28	-	
Fall Time	t_f		-	5.5	-	
Drain-Source Body Diode Characteristics						
Continuous Source-Drain Diode Current	I_S	MOSFET symbol showing the integral reverse p - n junction diode 	-	-	15	A
Pulsed Diode Forward Current ^a	I_{SM}		-	-	60	
Body Diode Voltage	V_{SD}	$T_J = 25\text{ }^\circ\text{C}$, $I_S = 15\text{ A}$, $V_{GS} = 0\text{ V}^b$	-	-	1.5	V
Body Diode Reverse Recovery Time	t_{rr}	$T_J = 25\text{ }^\circ\text{C}$, $I_F = 15\text{ A}$	-	130	200	ns
		$T_J = 125\text{ }^\circ\text{C}$, $dI/dt = 100\text{ A}/\mu\text{s}^b$	-	240	360	
Body Diode Reverse Recovery Charge	Q_{rr}	$T_J = 25\text{ }^\circ\text{C}$, $I_F = 15\text{ A}$, $V_{GS} = 0\text{ V}^b$	-	450	670	nC
		$T_J = 125\text{ }^\circ\text{C}$, $dI/dt = 100\text{ A}/\mu\text{s}^b$	-	1080	1620	
Reverse Recovery Time	I_{RRM}	$T_J = 25\text{ }^\circ\text{C}$	-	5.8	8.7	A
Forward Turn-On Time	t_{on}	Intrinsic turn-on time is negligible (turn-on is dominated by L_S and L_D)				

Notes

- Repetitive rating; pulse width limited by maximum junction temperature (see fig. 11).
- Pulse width $\leq 300\text{ }\mu\text{s}$; duty cycle $\leq 2\%$.
- $C_{oss\text{ eff.}}$ is a fixed capacitance that gives the same charging time as C_{oss} while V_{DS} is rising from 0 to 80% V_{DS} .
 $C_{oss\text{ eff. (ER)}}$ is a fixed capacitance that stores the same energy as C_{oss} while V_{DS} is rising from 0 to 80% V_{DS} .

TYPICAL CHARACTERISTICS 25 °C, unless otherwise noted

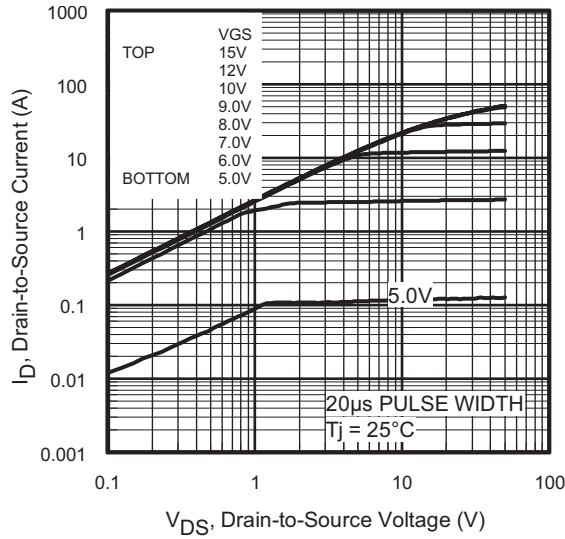

Fig. 1 - Typical Output Characteristics

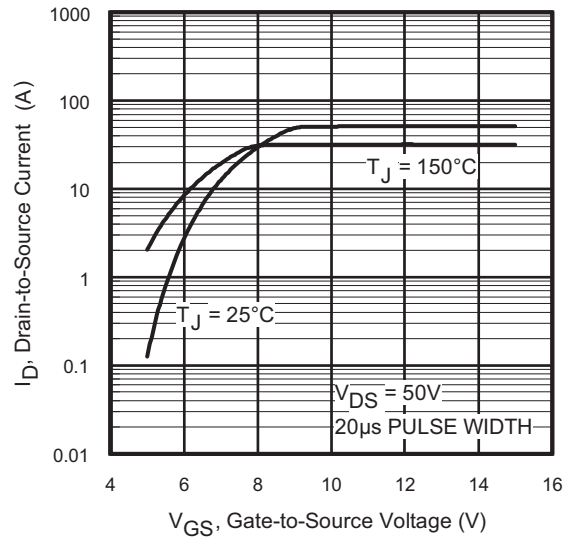

Fig. 3 - Typical Transfer Characteristics

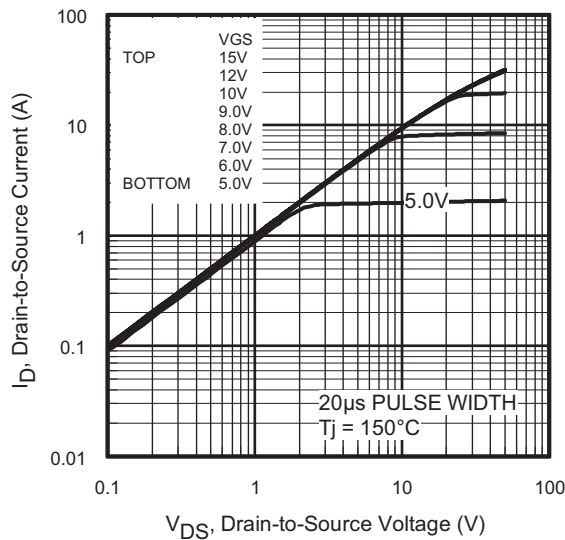

Fig. 2 - Typical Output Characteristics

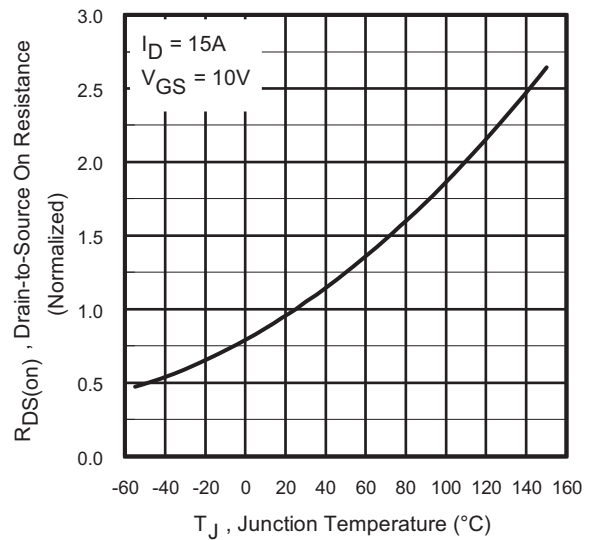

Fig. 4 - Normalized On-Resistance vs. Temperature

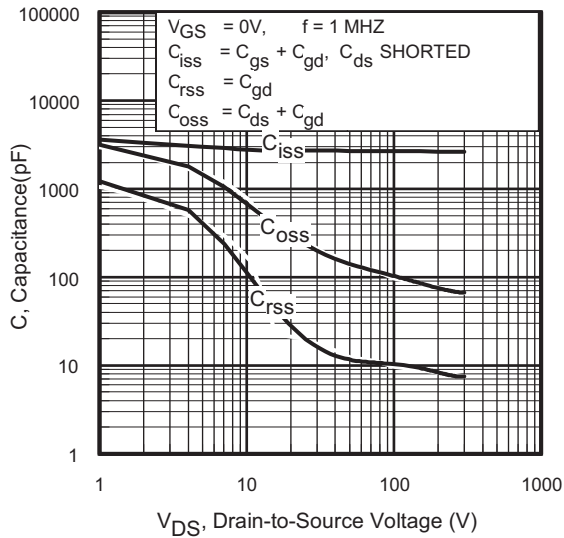

Fig. 5 - Typical Capacitance vs. Drain-to-Source Voltage

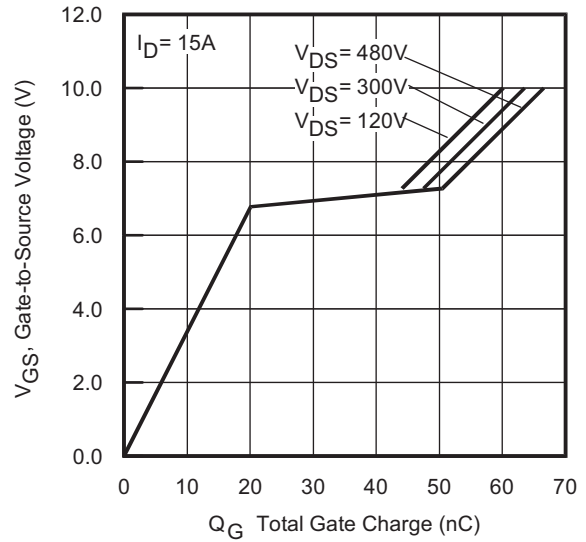

Fig. 7 - Typical Gate Charge vs. Gate-to-Source Voltage

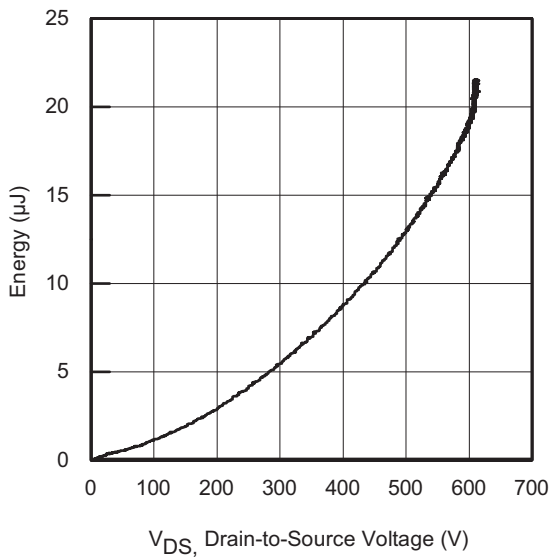

Fig. 6 - Typical Output Capacitance Stored Energy vs. V_{DS}

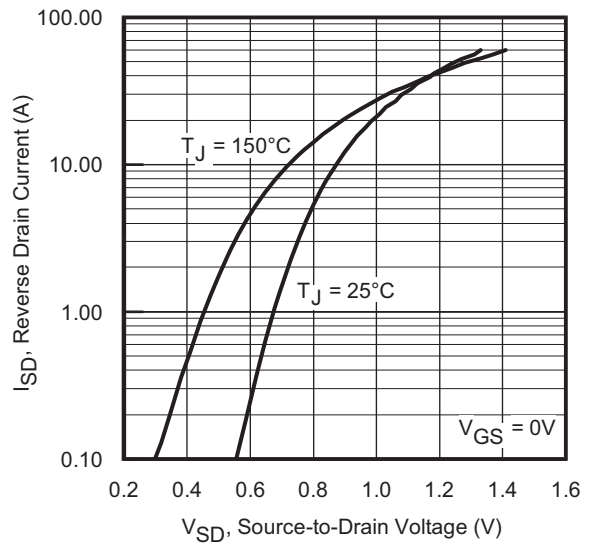

Fig. 8 - Typical Source-Drain Diode Forward Voltage

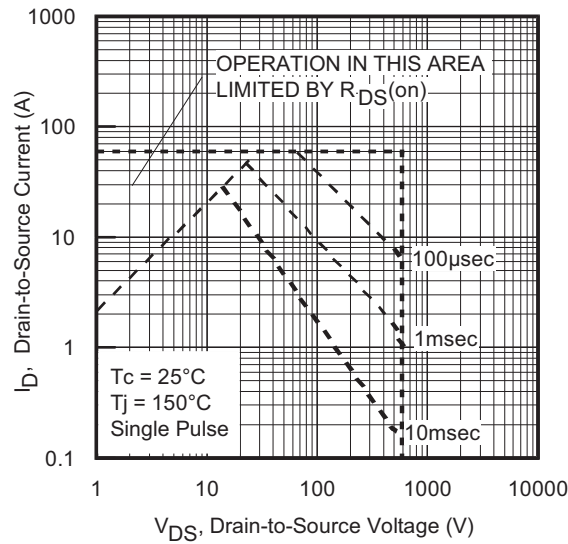

Fig. 9 - Maximum Safe Operating Area

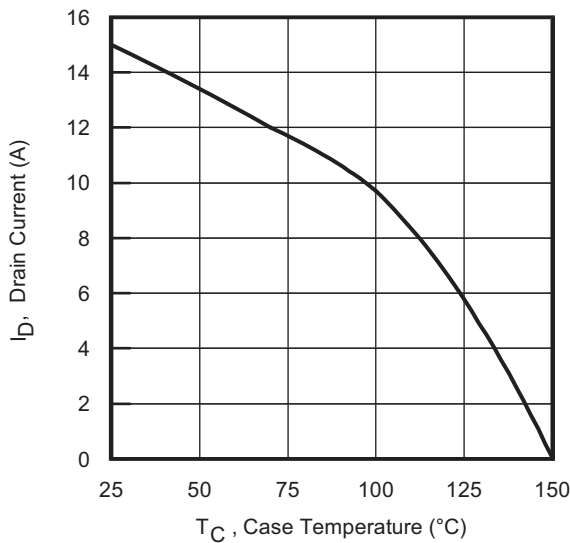

Fig. 10 - Maximum Drain Current vs. Case Temperature

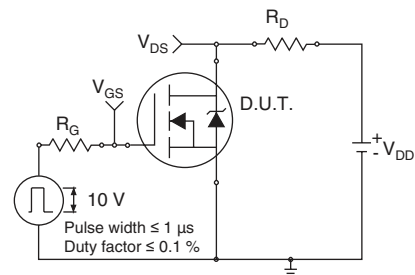

Fig. 11a - Switching Time Test Circuit

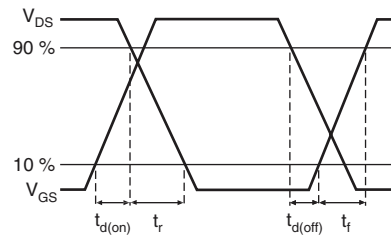

Fig. 11b - Switching Time Waveforms

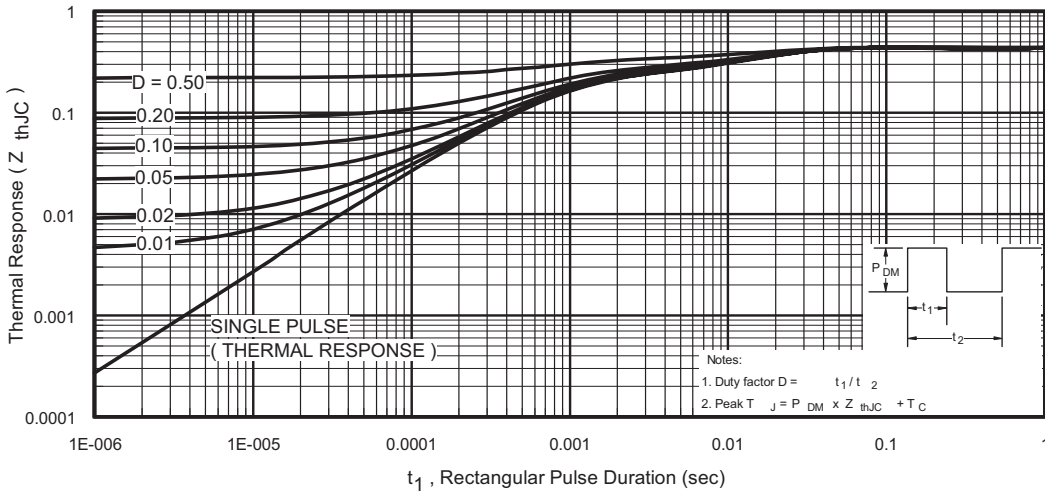

Fig. 12 - Maximum Effective Transient Thermal Impedance, Junction-to-Case

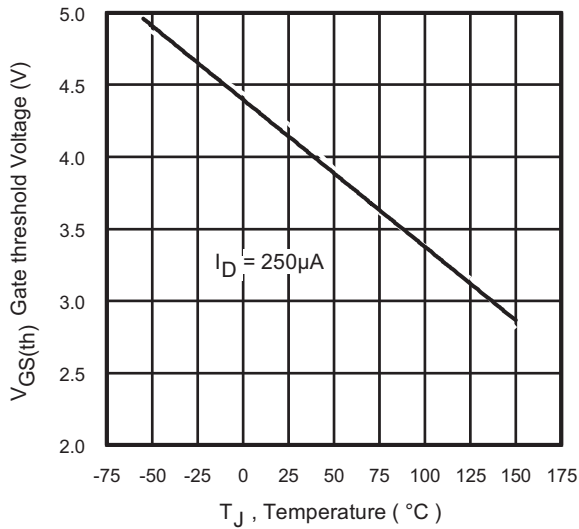

Fig. 13 - Threshold Voltage vs. Temperature

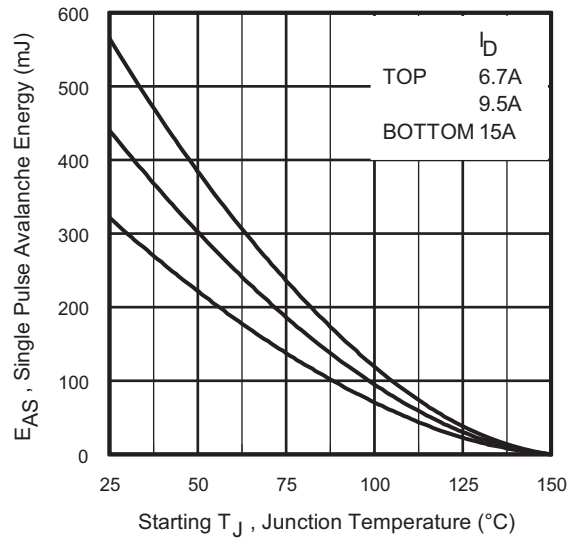

Fig. 14a - Maximum Avalanche Energy vs. Drain Current

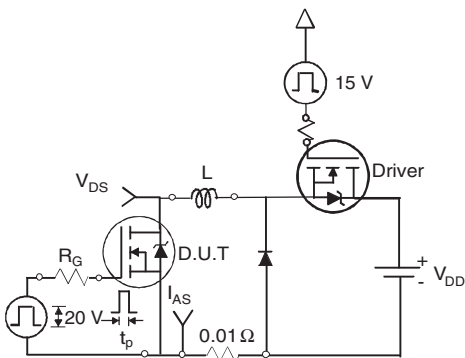

Fig. 14b - Unclamped Inductive Test Circuit

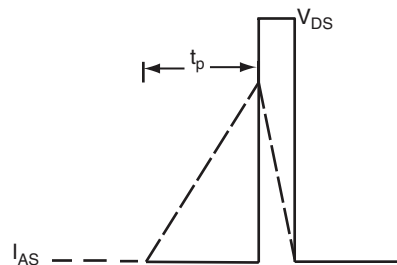

Fig. 14c - Unclamped Inductive Waveforms

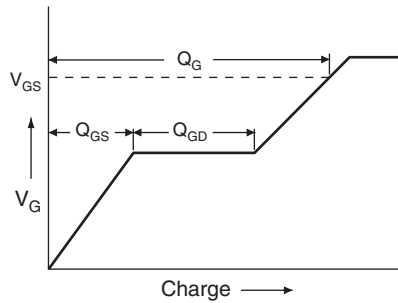

Fig. 15a - Basic Gate Charge Waveform

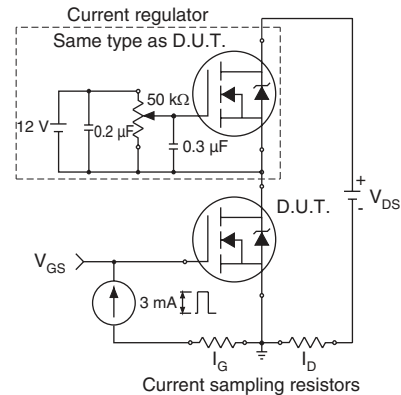

Fig. 15b - Gate Charge Test Circuit

Peak Diode Recovery dV/dt Test Circuit

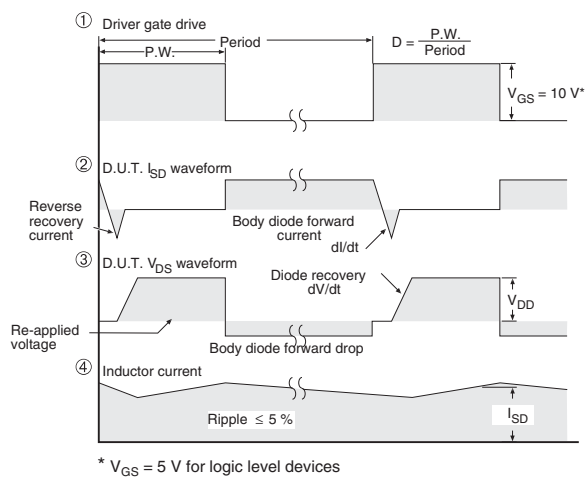
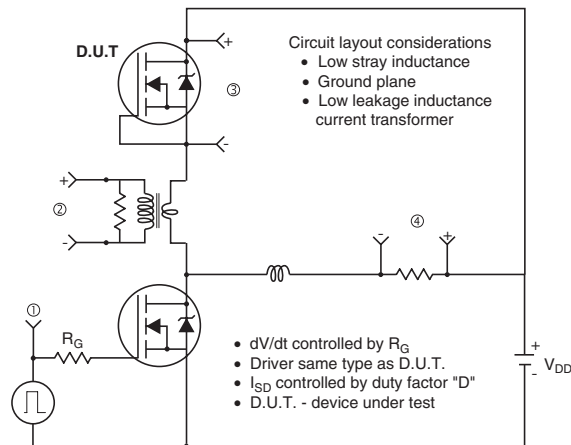

Fig. 16 - For N-Channel

Vishay Siliconix maintains worldwide manufacturing capability. Products may be manufactured at one of several qualified locations. Reliability data for Silicon Technology and Package Reliability represent a composite of all qualified locations. For related documents such as package/tape drawings, part marking, and reliability data, see <http://www.vishay.com/ppg?91204>.



Disclaimer

All product specifications and data are subject to change without notice.

Vishay Intertechnology, Inc., its affiliates, agents, and employees, and all persons acting on its or their behalf (collectively, "Vishay"), disclaim any and all liability for any errors, inaccuracies or incompleteness contained herein or in any other disclosure relating to any product.

Vishay disclaims any and all liability arising out of the use or application of any product described herein or of any information provided herein to the maximum extent permitted by law. The product specifications do not expand or otherwise modify Vishay's terms and conditions of purchase, including but not limited to the warranty expressed therein, which apply to these products.

No license, express or implied, by estoppel or otherwise, to any intellectual property rights is granted by this document or by any conduct of Vishay.

The products shown herein are not designed for use in medical, life-saving, or life-sustaining applications unless otherwise expressly indicated. Customers using or selling Vishay products not expressly indicated for use in such applications do so entirely at their own risk and agree to fully indemnify Vishay for any damages arising or resulting from such use or sale. Please contact authorized Vishay personnel to obtain written terms and conditions regarding products designed for such applications.

Product names and markings noted herein may be trademarks of their respective owners.