

Specifications

Parameter	Unit	Minimum	Typical	Maximum
Center Frequency	MHz	119.9	120	120.1
Insertion Loss	dB	-	24.6	29
2 dB Bandwidth	MHz	6.1	6.15	-
3 dB Bandwidth	MHz	-	6.24	-
22 dB Bandwidth	MHz	-	6.74	6.85
35 dB Bandwidth	MHz	-	6.88	7.2
40 dB Bandwidth	MHz	-	6.91	-
45 dB Bandwidth	MHz	-	6.94	7.8
50 dB Bandwidth	MHz	-	6.96	8
Passband Variation	dB	-	0.8	1.5
Absolute Delay	usec	-	4.23	4.5
Ultimate Rejection($f_0 \pm 4\text{MHz}$)	dB	50	55	-
Material Temperature coefficient	KHz/°C	-2.16		
Ambient Temperature	°C	25		
Package Size	DIP3512 (35.0x12.8x4.7mm ³)			

Notes:

1. All specifications are based on the test circuit shown
2. In production, devices will be tested at room temperature to a guardbanded specification to ensure electrical compliance over temperature
3. Electrical margin has been built into the design to account for the variations due to temperature drift and manufacturing tolerances
4. This is the optimum impedance in order to achieve the performance show

Matching Configuration

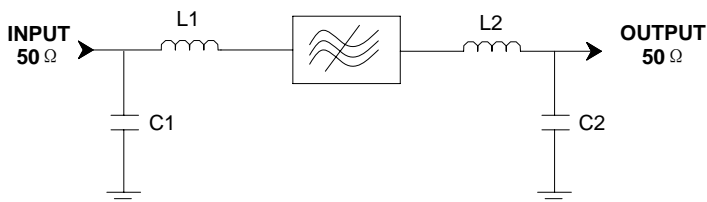

L1=47nH L2=56nH

C1=C2=56pF

Source/Load Impedance=50 ohm

Notes - Component values may change depending on board layout.



SIPAT Co., Ltd.
(CETC No. 26 Research Institute)
Nanping Huayuan Road No. 14
Chongqing, China, 400060

Part Number	LBT12023	
Rev. Date	2006-9-20	
Rev.	2.0	Page 1/3

Package Dimension

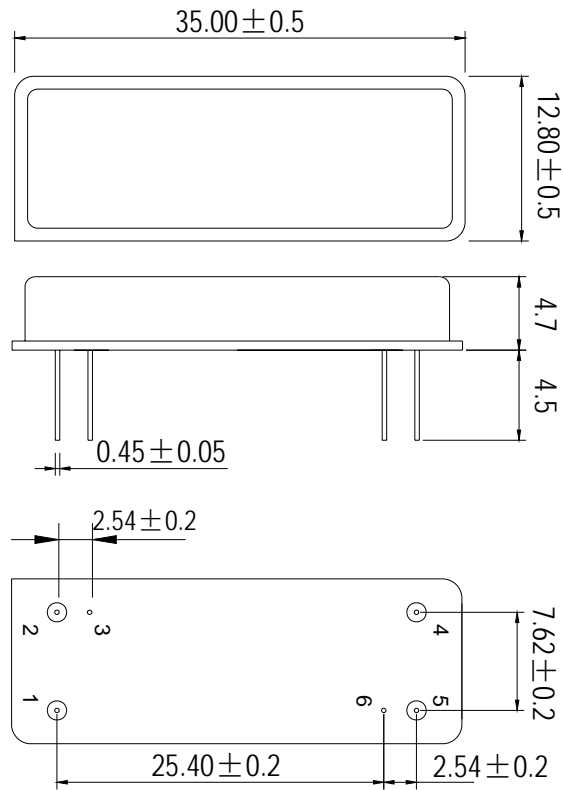

Input:1
Output:5



SIPAT Co., Ltd.
(CETC No. 26 Research Institute)
Nanping Huayuan Road No. 14
Chongqing, China, 400060

Part Number	LBT12023	
Rev. Date	2006-9-20	
Rev.	2.0	Page 2/3

Typical Performance

Frequency Respond

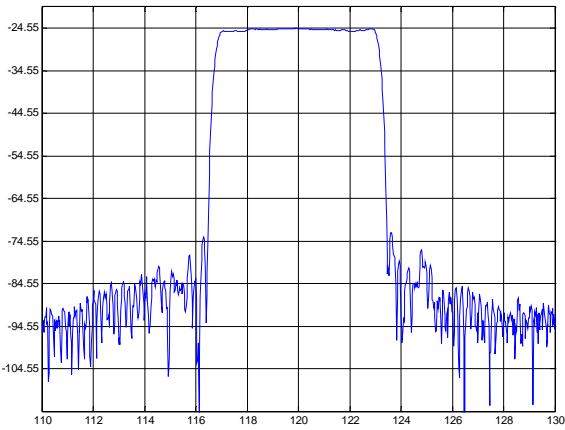

Passband Respond

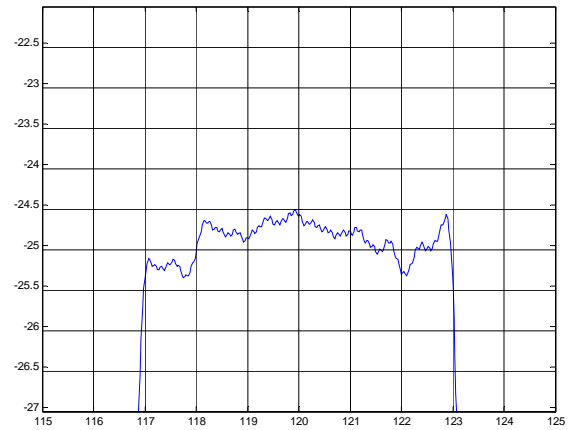

Group Delay Variation($f_0 \pm 2.9\text{MHz}$)

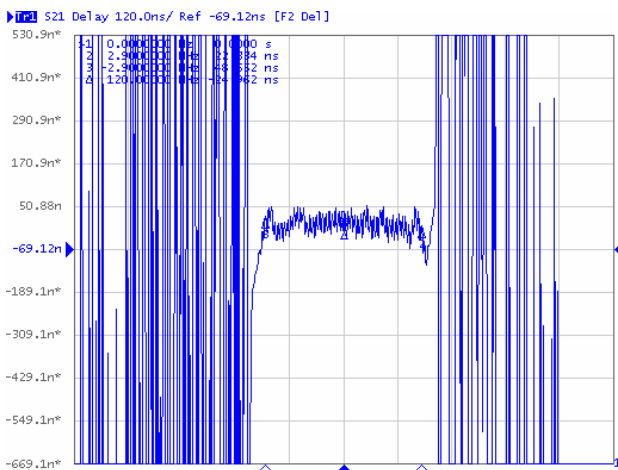

Phase Linearity($f_0 \pm 2.9\text{MHz}$)

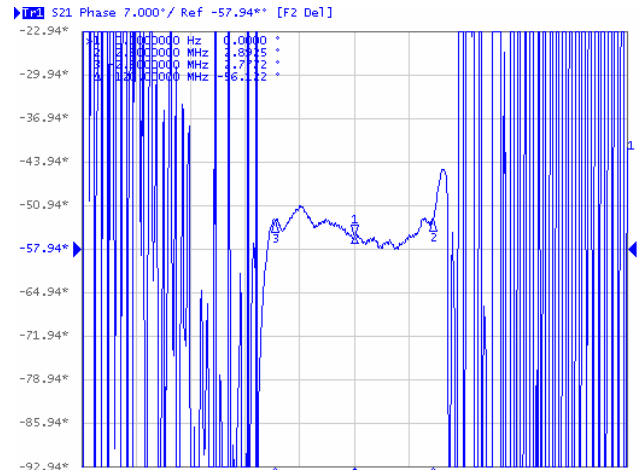

Smith Chart S11

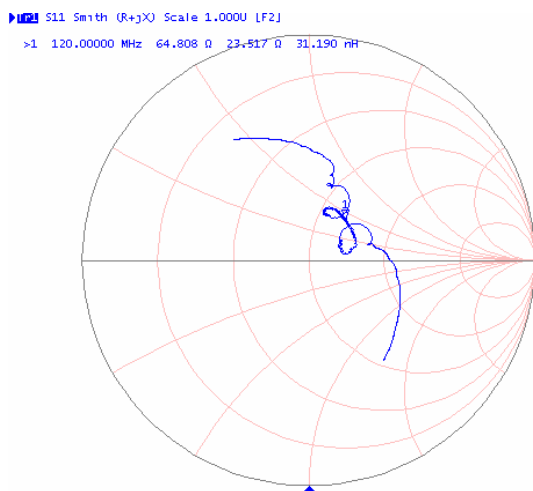

Smith Chart S22

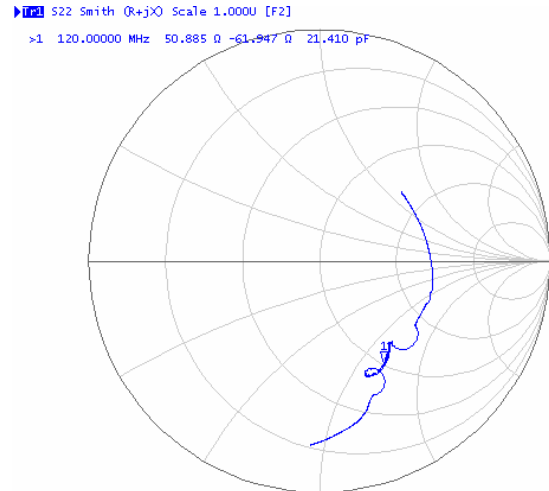

SIPAT Co., Ltd.
(CETC No. 26 Research Institute)
Nanping Huayuan Road No. 14
Chongqing, China, 400060

Part Number	LBT12023	
Rev. Date	2006-9-20	
Rev.	2.0	Page 3/3