

Key Features

- Output Accuracy: $\pm 2\%$
- Low Dropout Voltage: 180mV@150mA
- High PSRR: 70dB@100Hz
- Low Noise Output
- Current Limiting
- Short Circuit Protection
- Thermal Shutdown
- Space Saving Package SOT23-6
- Pb-Free Package

Applications

- Cellular Phone
- Portable Electronics, PDA
- Wireless Devices, Wireless LAN
- Computer Peripherals
- Camera Module
- GPS Receiver

General Description

The dual LDO PAM3102 series of positive voltage linear regulators feature high output voltage accuracy, low quiescent current and low dropout voltage, making them ideal for battery powered applications. The line transient response and load transient response are excellent. Their high PSRR make them useful in applications where AC noise on the input power supply must be suppressed. Space-saving SOT23-6 package for 2-ch LDOs is attractive for portable and handheld applications. They have both thermal shutdown and a current limit feature to prevent device failure under extreme operating conditions. They are stable with an output capacitance of 2.2 μ F or greater.

Typical Application

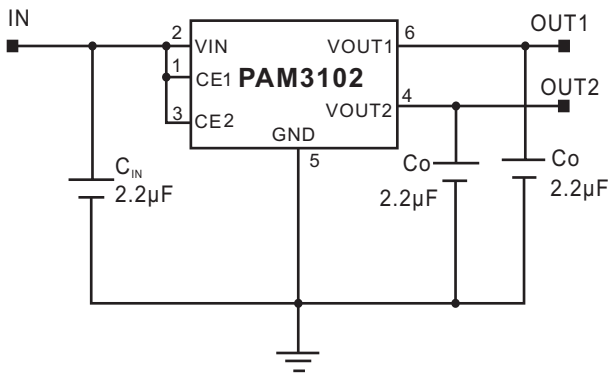

Block Diagram

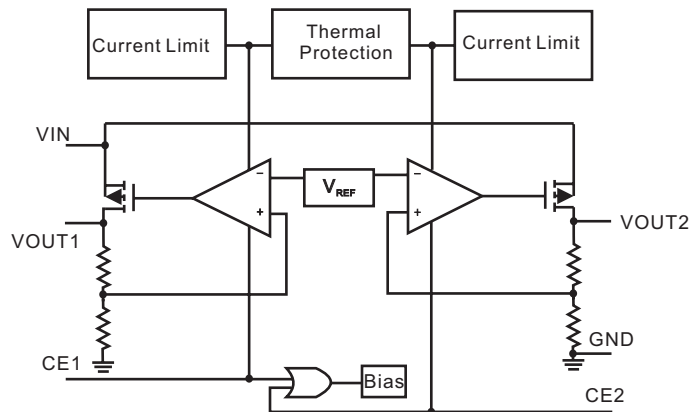

Pin Configuration & Marking Information

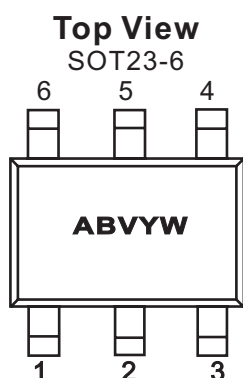

AB: Product Code of PAM3102
 V: Voltage Code
 Y: Year
 W: Week

Pin Number	Name	Function
1	CE1	Output 1 Enable
2	VIN	Input
3	CE2	Output 2 Enable
4	VOUT2	Output 2
5	GND	Ground
6	VOUT1	Output 1

Absolute Maximum Ratings

These are stress ratings only and functional operation is not implied. Exposure to absolute maximum ratings for prolonged time periods may affect device reliability. All voltages are with respect to ground.

Input Voltage.....	6.6V	Storage Temperature.....	-40°C to 125°C
Output Current.....	150/150mA	ESD Rating(HBM).....	2kV
Output Pin Voltage.....	GND-0.3V to V _{IN} +0.3V	Lead Soldering Temperature (5sec)	300°C

Recommended Operating Conditions

Supply Input Voltage.....	5.5V	Junction Temperature.....	-40°C to 125°C
Max. Supply Voltage (for Max. duration of 30 minutes).....	6.4V	Ambient Temperature.....	-40°C to 85°C
Enable Input Voltage.....	0V to V _{IN}		

Thermal Information

Parameter	Symbol	Package	Maximum	Unit
Thermal Resistance (Junction to Case)	θ_{JC}	SOT-23-6	130	°C/W
Thermal Resistance (Junction to Ambient)	θ_{JA}	SOT-23-6	250	
Internal Power Dissipation	P _D	SOT-23-6	400	mW



Electrical Characteristic

$V_{CE1}=V_{CE2}=V_{IN}=V_O+1V$, $T_A=25^\circ C$, $C_{IN}=2.2\mu F$, $C_O=2.2\mu F$, unless otherwise noted.

PARAMETER	SYMBOL	Test Conditions		MIN	TYP	MAX	UNITS
Input Voltage	V_{IN}			Note 1		5.5	V
Output Voltage Accuracy	V_O	$I_O=1mA$		-2.0		2.0	%
Dropout Voltage	V_{drop}	$V_O=1.8V$, $I_O=150mA$			950		mV
		$V_O=2.5V$, $I_O=150mA$			350		mV
		$V_O=2.8V$, $I_O=150mA$			180		mV
Output Current	I_O			150		Note 2	mA
Current Limit	I_{LIM}	$V_O \geq 1.2V$			200		mA
Quiescent Current	I_Q	$I_O=0mA$			175	250	μA
Ground Pin Current	I_{gnd}	$I_O=1mA$ to 150mA			200	250	μA
Shutdown Current	I_{SD}	$V_{CE1}=V_{CE2}=0V$			0.1	1	μA
Short Circuit Current	I_{sc}	$V_O=0V$			150		mA
Line Regulation	LNR	$I_O=50mA$ $V_{IN}=3.0V$ to 4.0V	$V_O=1.8V$	-0.15	0.1	0.15	%V
		$I_O=50mA$, $V_{IN}=3.5V$ to 4.5V	$V_O=2.5V$				
		$I_O=50mA$, $V_{IN}=3.8V$ to 4.8V	$V_O=2.8V$				
Load Regulation	LDR	$V_{IN}=3.3V$ $I_O=1mA$ to 150mA		-2	1.0	2	%
Power Supply Ripple Rejection	PSRR	$I_O=50mA$, $V_O=1.8V$	$f=100Hz$		70		dB
			$f=1kHz$		63		dB
			$f=10kHz$		45		dB
Output Noise	V_n	$f=10Hz$ to 100kHz			35		μV_{rms}
CE Input High Threshold	V_{TH}			1.5			V
CE Input Low Threshold	V_{TL}					0.3	V
CE Pull-Up Resistance	R_{CE}			1.7	5	15	$M\Omega$
Temperature Coefficient	T_c				40		ppm/ $^\circ C$
Over Temperature Shutdown	OTS	$I_O=1mA$			155		$^\circ C$
Over Temperature Hysteresis	OTH	$I_O=1mA$			40		$^\circ C$

Note1: The minimum input voltage ($V_{IN(MIN)}$) of the PAM3102 is determined by output voltage and dropout voltage. The minimum input voltage is defined as:

$$V_{IN(MIN)} = V_O + V_{drop}$$

Note 2: Output current is limited by P_D , maximum $I_O = P_D / (V_{IN(MAX)} - V_O)$.



Typical Performance Characteristics

$T_A=25^\circ\text{C}$, $C_{IN}=2.2\mu\text{F}$, $C_O=2.2\mu\text{F}$, unless otherwise noted.

1. Output Voltage vs Input Voltage

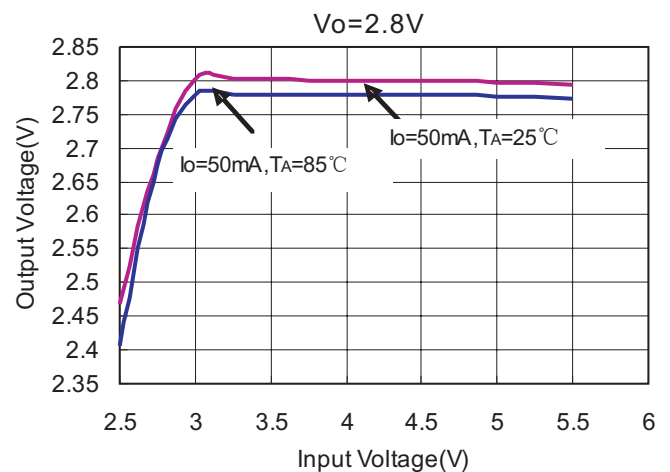
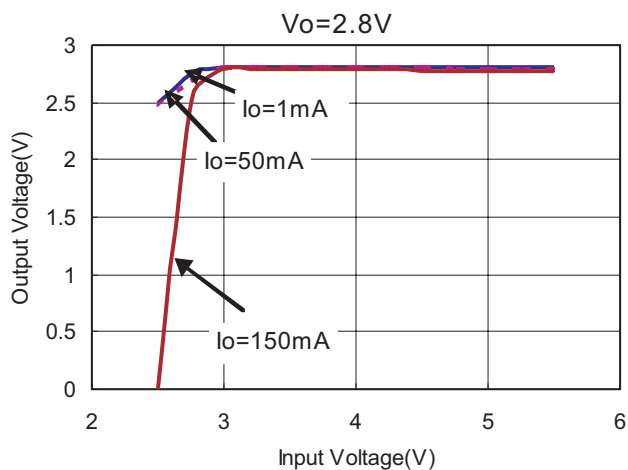
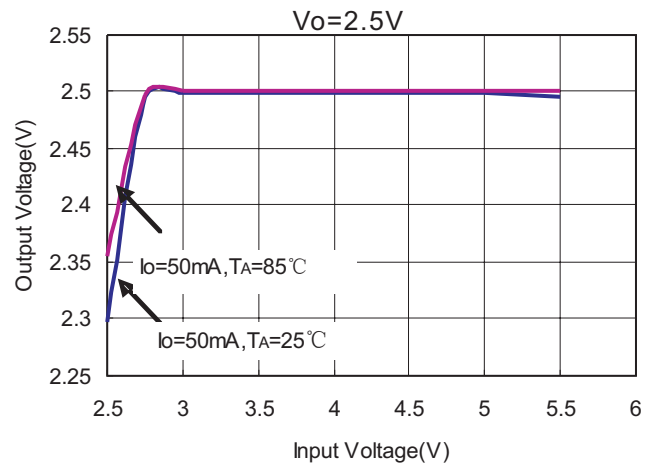
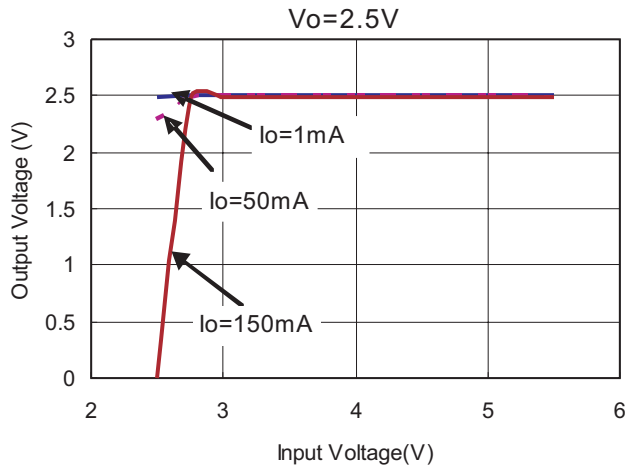
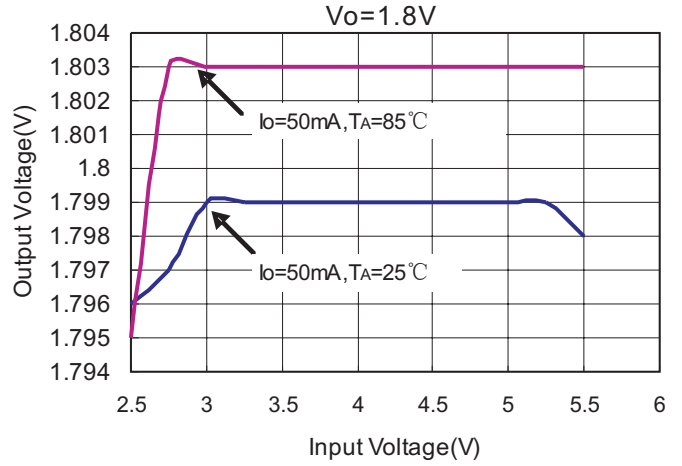
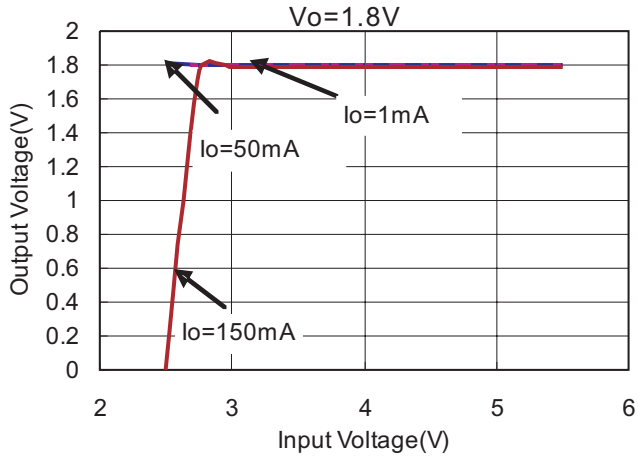

Typical Performance Characteristics (continued)

2. Output Voltage vs Output Current

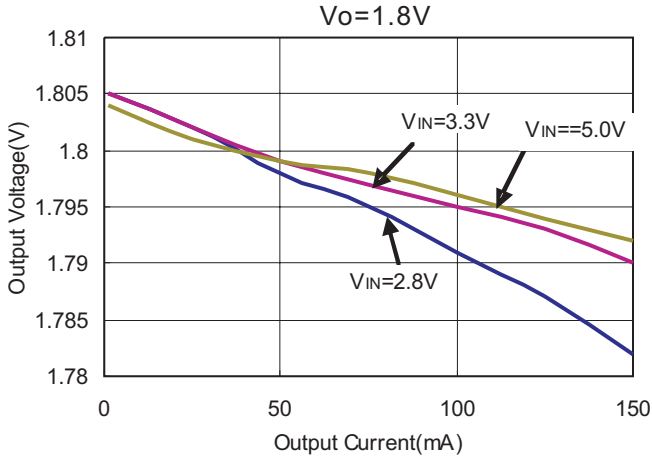

3. Output Voltage vs Temperature

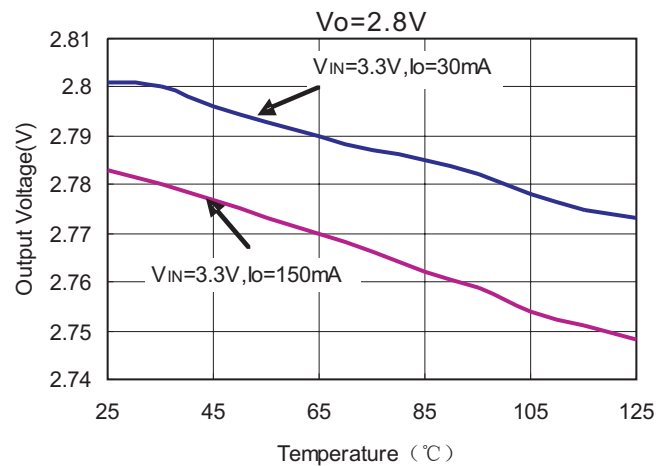
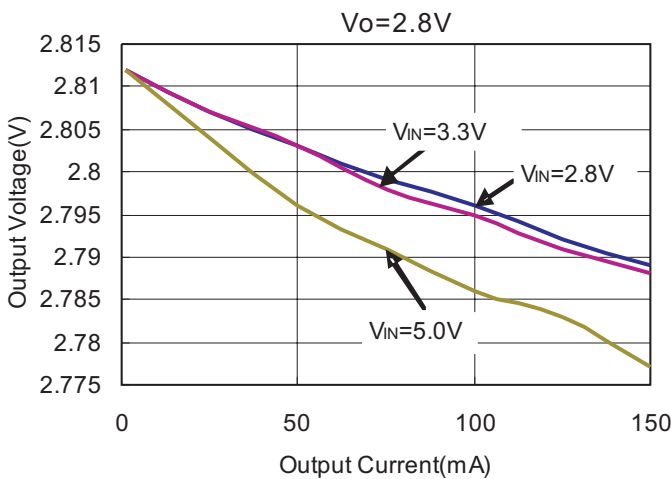
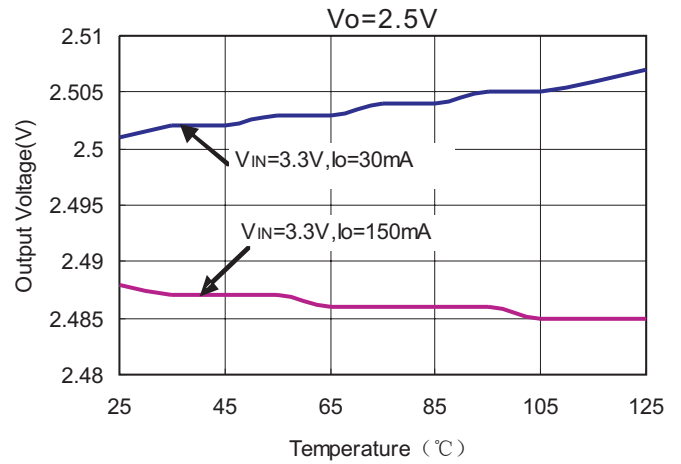
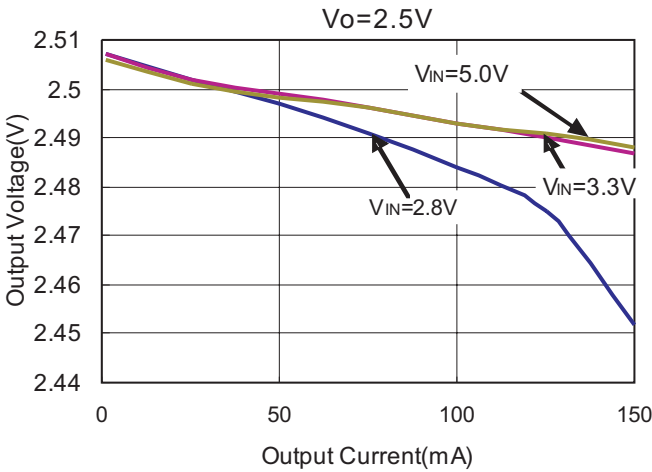
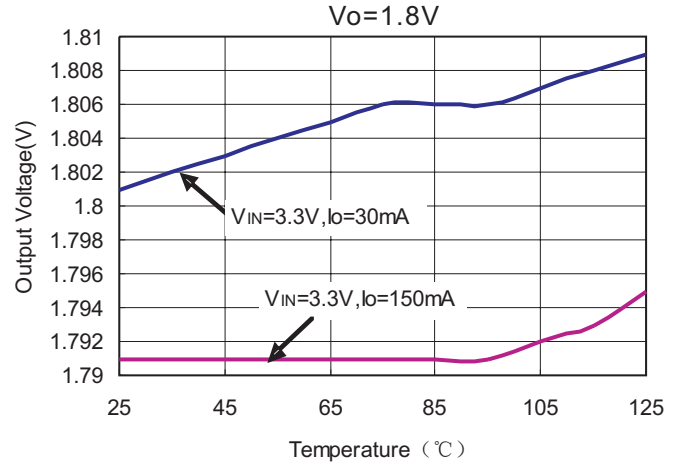

Typical Performance Characteristics (continued)

4. Ground Current vs Input Voltage

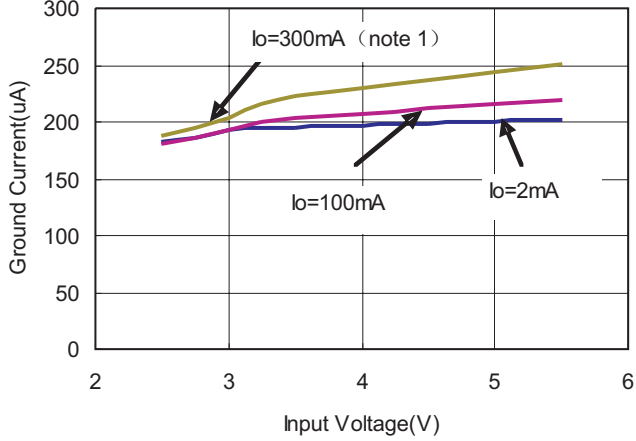

5. Ground Current vs Output Current

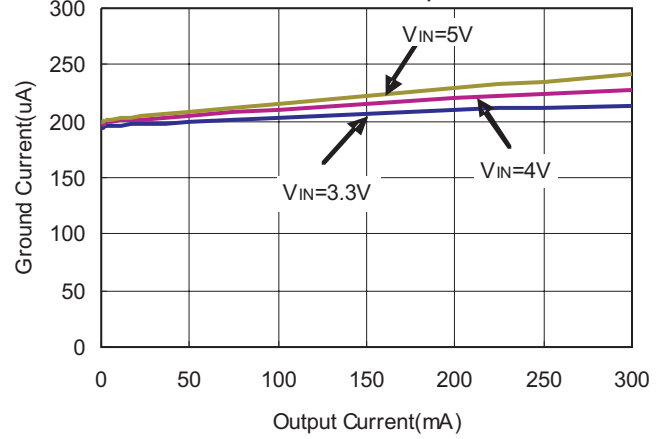

6. Quiescent Current vs Input Voltage

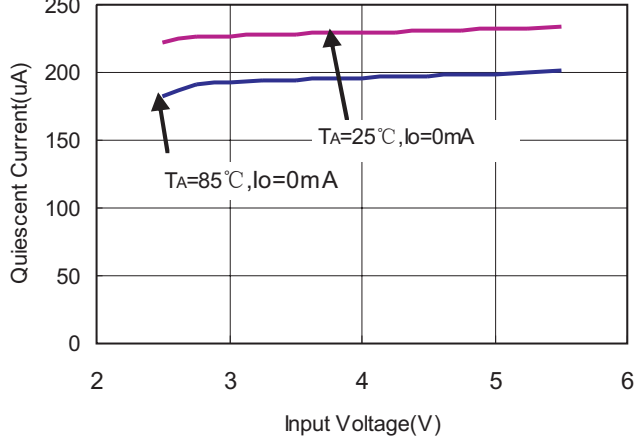

7. Quiescent Current vs Temperature

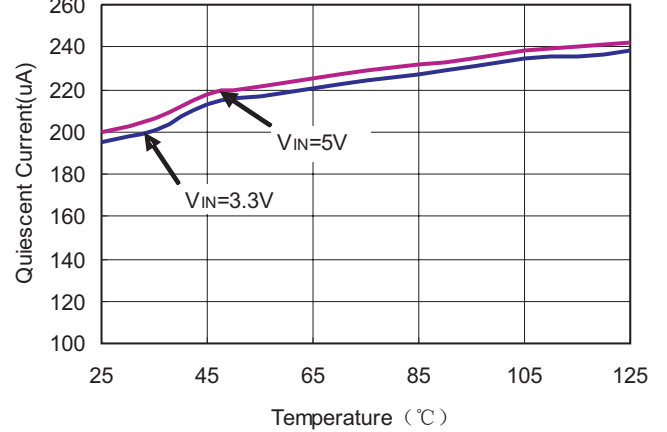

8. Dropout Voltage vs Output Current

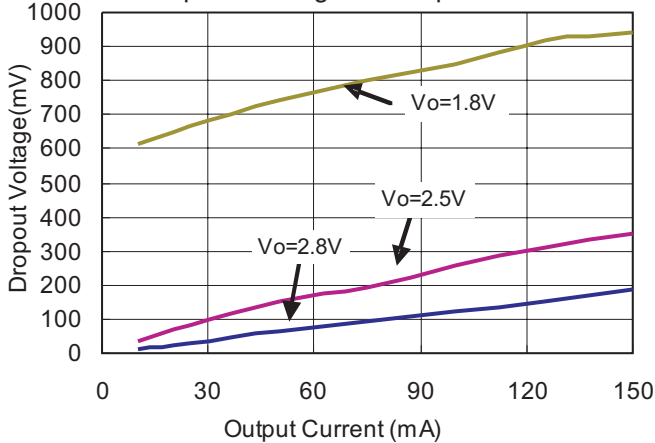

9. Dropout Voltage vs Temperature

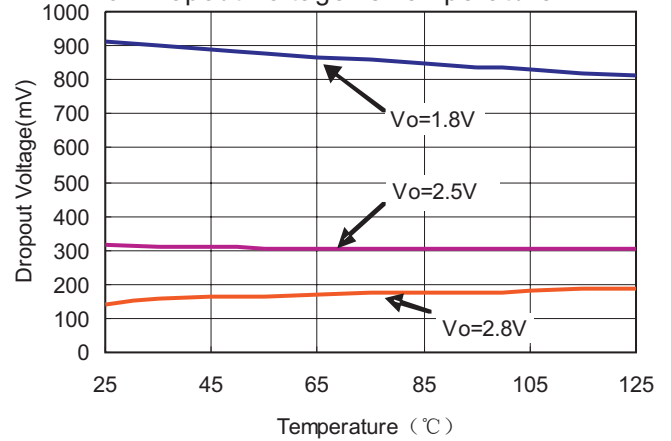

note 1: 2 channels total output current

Io=150mA

Typical Performance Characteristics (continued)

10. Power Supply Ripple Rejection

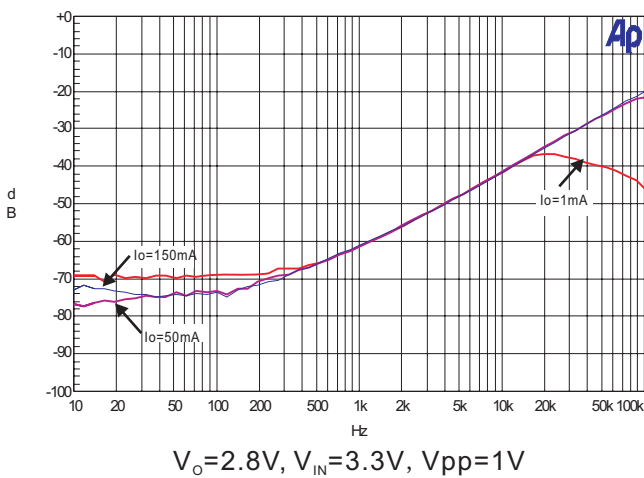
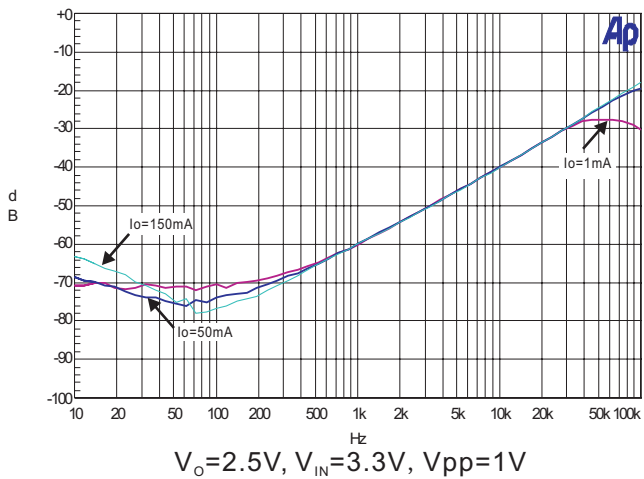
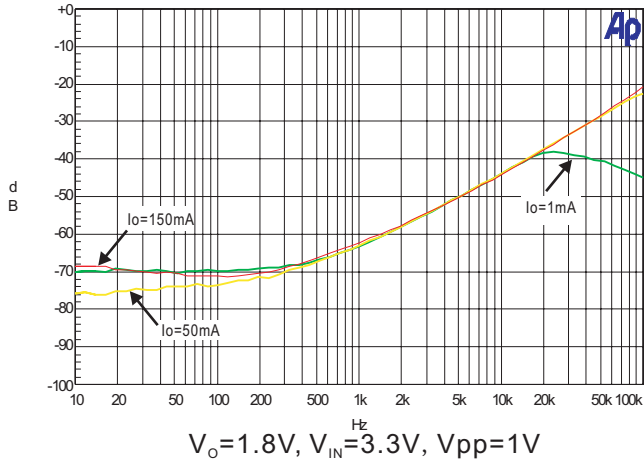

11. Load Transient Response

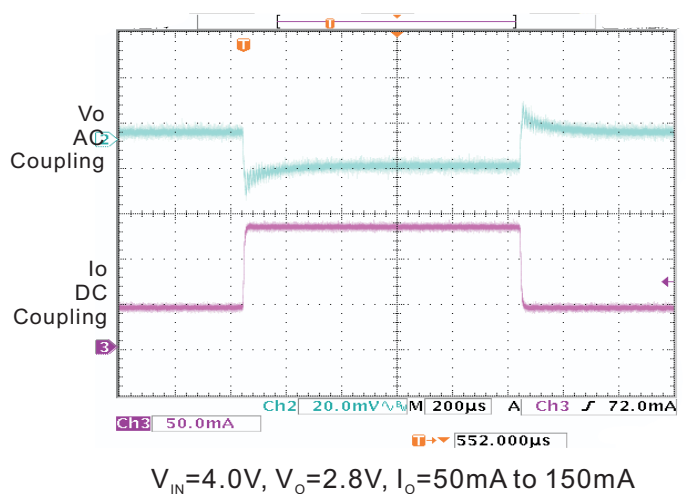
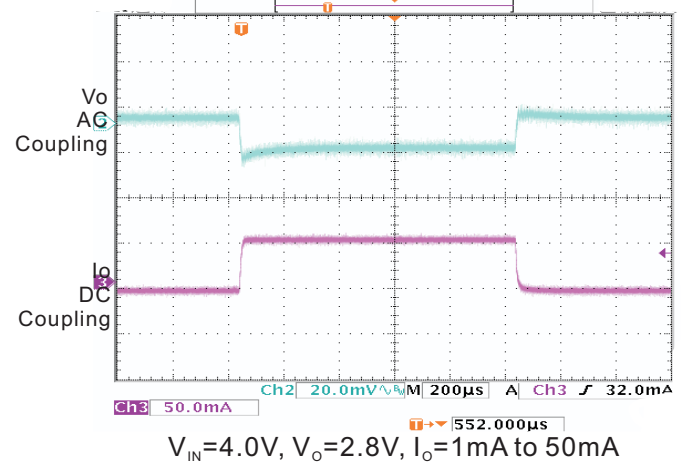
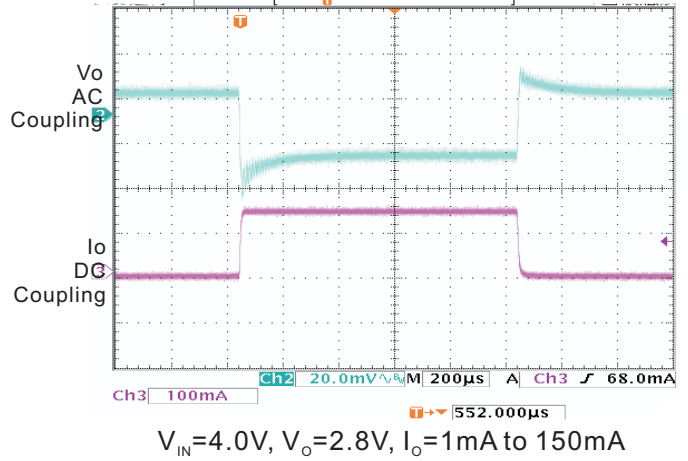

Typical Performance Characteristics (continued)

12. Line Transient Response

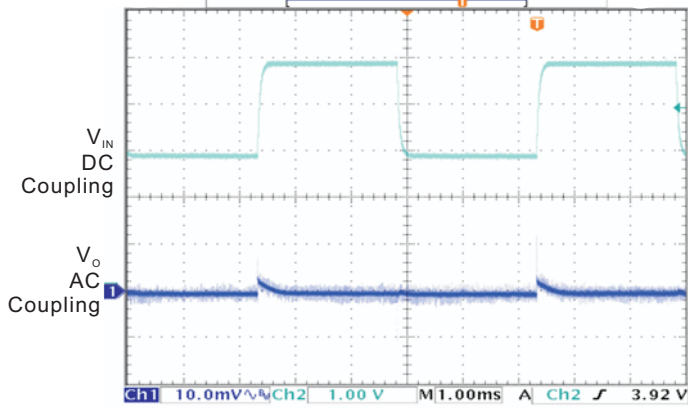

$V_o=2.5V, V_{IN}=3V \text{ to } 5V, I_o=1mA$

13. Turn-on Response

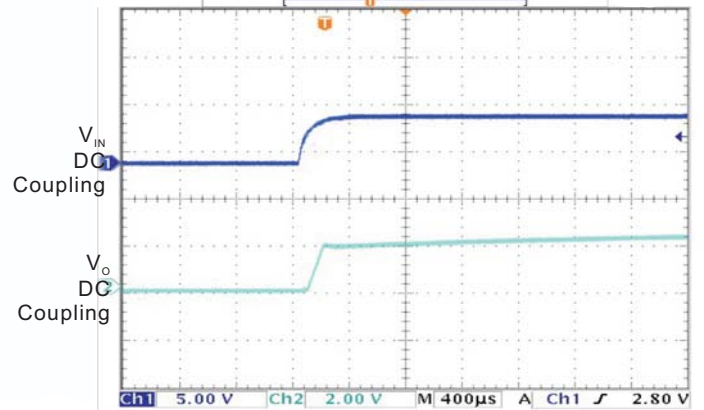

$V_{IN}=0 \text{ to } 5V$



Application Information

Capacitor Selection and Regulator Stability

Similar to any low dropout regulator, the external capacitors used with the PAM3102 must be carefully selected for regulator stability and performance.

A capacitor C_{IN} of more than $1\mu F$ can be employed in the input pin, while there is no upper limit for the capacitance of C_{IN} . Please note that the distance between C_{IN} and the input pin of the PAM3102 should not exceed 0.5 inch. Ceramic capacitors are suitable for the PAM3102. Capacitors with larger values and lower ESR (equivalent series resistance) provide better PSRR and line-transient response.

The PAM3102 is designed specifically to work with low ESR ceramic output capacitors in order to save space and improve performance. Using an output ceramic capacitor whose value is $>2.2\mu F$ with $ESR > 5m\Omega$ ensures stability.

Shutdown Input Operation

The PAM3102 is shutdown by pulling the CE input low, and turned on by tying the CE input to VIN or leaving the CE input floating.

Input-Output (Dropout) Voltage

A regulator's minimum input-output voltage differential (or dropout voltage) determines the lowest usable supply voltage. The PAM3102 has a typical 180mV dropout voltage. In battery-powered systems, this will determine the useful end-of-life battery voltage.

Current Limit and Short Circuit Protection

The PAM3102 features a current limit, which monitors and controls the gate voltage of the pass transistor. The output current can be limited to 300mA by regulating the gate voltage. The PAM3102 also has a built-in short circuit current limit.

Thermal considerations

Thermal protection limits power dissipation in the PAM3102. When the junction temperature exceeds $150^{\circ}C$, the OTP (Over Temperature Protection) starts the thermal shutdown and turns the pass transistor off. The pass transistor

resumes operation after the junction temperature drops below $120^{\circ}C$.

For continuous operation, the junction temperature should be maintained below $125^{\circ}C$. The power dissipation is defined as:

$$P_D = (V_{IN} - V_O) * I_O + V_{IN} * I_{GND}$$

The maximum power dissipation depends on the thermal resistance of IC package, PCB layout, the rate of surrounding airflow and temperature difference between junction and ambient. The maximum power dissipation can be calculated by the following formula:

$$P_{D(MAX)} = (T_{J(MAX)} - T_A) / \theta_{JA}$$

Where $T_{J(MAX)}$ is the maximum allowable junction temperature $125^{\circ}C$, T_A is the ambient temperature and θ_{JA} is the thermal resistance from the junction to the ambient.

For example, as θ_{JA} is $250^{\circ}C/W$ for the SOT-23 package based on the standard JEDEC 51-3 for a single-layer thermal test board, the maximum power dissipation at $T_A = 25^{\circ}C$ can be calculated by following formula:

$$P_{D(MAX)} = (125^{\circ}C - 25^{\circ}C) / 250 = 0.4W \text{ SOT-23}$$

It is also useful to calculate the junction temperature of the PAM3102 under a set of specific conditions. Suppose the input voltage $V_{IN} = 3.3V$, the output current $I_O = 300mA$ and the case temperature $T_A = 40^{\circ}C$ measured by a thermocouple during operation, the our power dissipation is defined as:

$$P_D = (3.3V - 2.8V) * 150mA + (3.3V - 1.8V) * 150mA + 3.3V * 200\mu A \approx 300mW$$

And the junction temperature T_J can be calculated as follows:

$$\begin{aligned} T_J &= T_A + P_D * \theta_{JA} \\ T_J &= 40^{\circ}C + 0.3W * 250^{\circ}C/W \\ &= 40^{\circ}C + 75^{\circ}C \\ &= 115^{\circ}C < T_{J(MAX)} = 125^{\circ}C \end{aligned}$$

For this application, T_J is lower than the absolute maximum operating junction temperature, $125^{\circ}C$, so it is safe to use the PAM3102 in this configuration.



Ordering Information

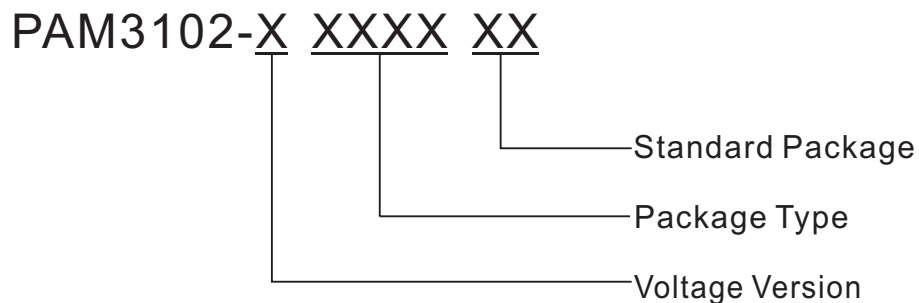

Part Number	Output Voltage	Marking	Package Type	Standard Package
PAM3102-AST26R1	VOUT1 1.8V VOUT2 2.8V	ABAYW	SOT-23-6	3,000Units/Tape&Reel
PAM3102-BST26R1	VOUT1 1.8V VOUT2 2.5V	ABBYW	SOT-23-6	3,000Units/Tape&Reel

Outline Dimension

SOT23-6

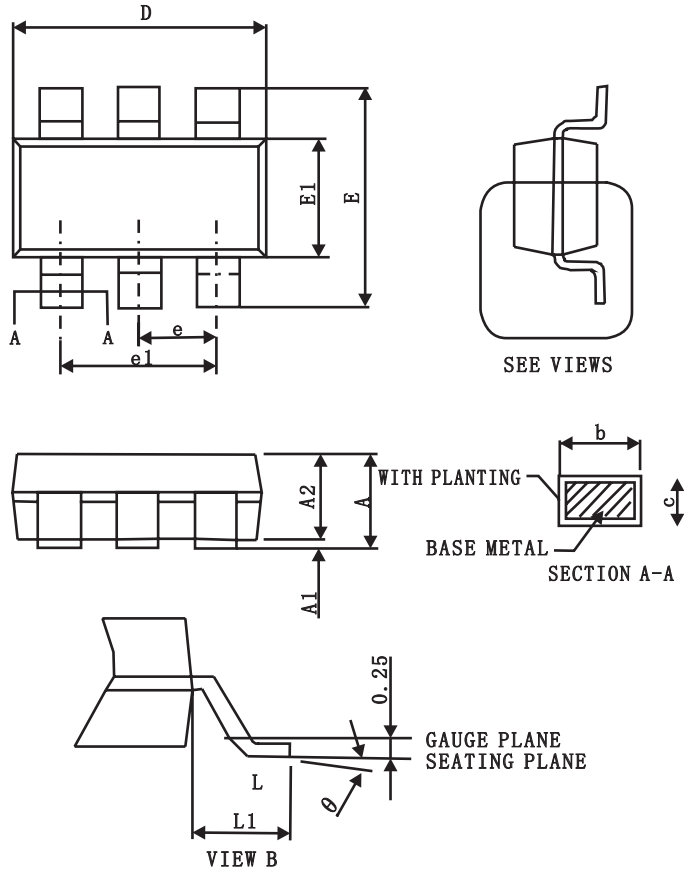

Symbol	A	A1	A2	b	c	D	E
Spec	1.20±0.25	0.10±0.05	1.10±0.2	0.40±0.1	0.15±0.07	2.90±0.1	2.80±0.2
Symbol	E1	e	e 1	L	L1	θ	
Spec	1.60±0.1	0.95BSC	1.90BSC	0.55±0.25	0.60REF	4°±4°	

Unit: Millimeter