

**13.56 MHz short-range contactless memory chip
with 512-bit EEPROM and anticollision functions**

Features

- ISO 14443-2 Type B air interface compliant
- ISO 14443-3 Type B frame format compliant
- 13.56 MHz carrier frequency
- 847 kHz subcarrier frequency
- 106 Kbit/second data transfer
- 8 bit Chip_ID based anticollision system
- 2 Count-down binary counters with automated antitearing protection
- 64-bit Unique Identifier
- 512-bit EEPROM with write protect feature
- Read_block and Write_block (32 bits)
- Internal tuning capacitor
- 1million erase/write cycles
- 40-year data retention
- Self-timed programming cycle
- 5 ms typical programming time

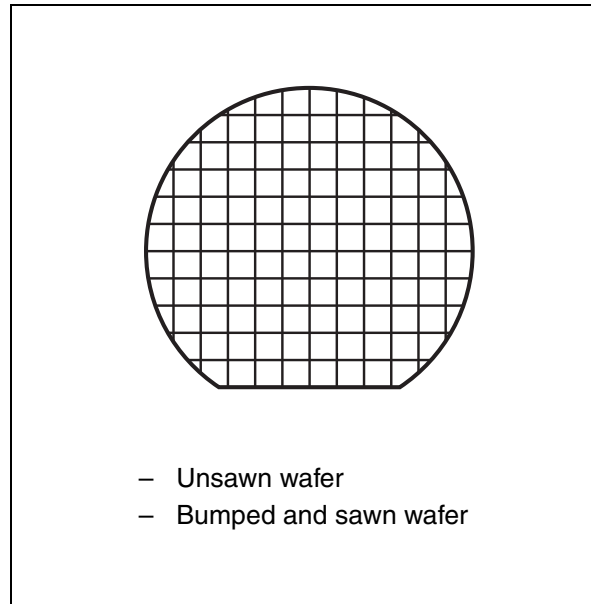

Contents

- 1 Description 7**
- 2 Signal description 8**
 - 2.1 AC1, AC0 8
- 3 Data transfer 9**
 - 3.1 Input data transfer from the reader to the SRI512 (request frame) 9
 - 3.1.1 Character transmission format for request frame 9
 - 3.1.2 Request start of frame 10
 - 3.1.3 Request end of frame 10
 - 3.2 Output data transfer from the SRI512 to the reader (answer frame) 11
 - 3.2.1 Character transmission format for answer frame 11
 - 3.2.2 Answer start of frame 11
 - 3.2.3 Answer end of frame 12
 - 3.3 Transmission frame 12
 - 3.4 CRC 13
- 4 Memory mapping 14**
 - 4.1 Resettable OTP area 15
 - 4.2 32-bit binary counters 16
 - 4.3 EEPROM area 18
 - 4.4 System area 19
 - 4.4.1 OTP_Lock_Reg 19
 - 4.4.2 Fixed Chip_ID (option) 20
- 5 SRI512 operation 21**
- 6 SRI512 states 22**
 - 6.1 Power-off state 22
 - 6.2 Ready state 22
 - 6.3 Inventory state 22
 - 6.4 Selected state 22
 - 6.5 Deselected state 22

| | | |
|--|--|-----------|
| 6.6 | Deactivated state | 22 |
| 7 | Anticollision | 24 |
| 7.1 | Description of an anticollision sequence | 26 |
| 8 | SRI512 commands | 28 |
| 8.1 | Initiate() command | 29 |
| 8.2 | Pcall16() command | 30 |
| 8.3 | Slot_marker(SN) command | 31 |
| 8.4 | Select(Chip_ID) command | 32 |
| 8.5 | Completion() command | 33 |
| 8.6 | Reset_to_inventory() command | 34 |
| 8.7 | Read_block(Addr) command | 35 |
| 8.8 | Write_block (Addr, Data) command | 36 |
| 8.9 | Get_UID() command | 37 |
| 8.10 | Power-on state | 38 |
| 9 | Maximum rating | 39 |
| 10 | DC and AC parameters | 40 |
| 11 | Part numbering | 42 |
| Appendix A ISO 14443 Type B CRC calculation | | 43 |
| Appendix B SRI512 command brief | | 44 |
| Revision history | | 46 |

List of tables

| | | |
|-----------|---|----|
| Table 1. | Signal names | 7 |
| Table 2. | Bit description | 10 |
| Table 3. | SRI512 memory mapping | 14 |
| Table 4. | Standard anticollision sequence | 26 |
| Table 5. | Command code | 28 |
| Table 6. | Absolute maximum ratings | 39 |
| Table 7. | Operating conditions | 40 |
| Table 8. | DC characteristics | 40 |
| Table 9. | AC characteristics | 40 |
| Table 10. | Ordering information scheme | 42 |
| Table 11. | Document revision history | 46 |

List of figures

| | | |
|------------|---|----|
| Figure 1. | Logic diagram | 7 |
| Figure 2. | Die floor plan. | 8 |
| Figure 3. | 10% ASK modulation of the received wave | 9 |
| Figure 4. | SRI512 request frame character format | 9 |
| Figure 5. | Request start of frame | 10 |
| Figure 6. | Request end of frame | 10 |
| Figure 7. | Wave transmitted using BPSK subcarrier modulation | 11 |
| Figure 8. | Answer start of frame | 11 |
| Figure 9. | Answer end of frame. | 12 |
| Figure 10. | Example of a complete transmission frame | 12 |
| Figure 11. | CRC transmission rules | 13 |
| Figure 12. | Resettable OTP area (addresses 0 to 4) | 15 |
| Figure 13. | Write_block update in standard mode (binary format) | 15 |
| Figure 14. | Write_block update in reload mode (binary format) | 16 |
| Figure 15. | Binary counter (addresses 5 to 6). | 16 |
| Figure 16. | Count down example (binary format) | 17 |
| Figure 17. | EEPROM (addresses 7 to 15) | 18 |
| Figure 18. | System area | 19 |
| Figure 19. | State transition diagram | 23 |
| Figure 20. | SRI512 Chip_ID description | 24 |
| Figure 21. | Description of a possible anticollision sequence | 25 |
| Figure 22. | Example of an anticollision sequence. | 27 |
| Figure 23. | Initiate request format | 29 |
| Figure 24. | Initiate response format | 29 |
| Figure 25. | Initiate frame exchange between reader and SRI512 | 29 |
| Figure 26. | Pcall16 request format | 30 |
| Figure 27. | Pcall16 response format. | 30 |
| Figure 28. | Pcall16 frame exchange between reader and SRI512 | 30 |
| Figure 29. | Slot_marker request format | 31 |
| Figure 30. | Slot_marker response format | 31 |
| Figure 31. | Slot_marker frame exchange between reader and SRI512 | 31 |
| Figure 32. | Select request format | 32 |
| Figure 33. | Select response format. | 32 |
| Figure 34. | Select frame exchange between reader and SRI512 | 32 |
| Figure 35. | Completion request format | 33 |
| Figure 36. | Completion response format. | 33 |
| Figure 37. | Completion frame exchange between reader and SRI512. | 33 |
| Figure 38. | Reset_to_inventory request format. | 34 |
| Figure 39. | Reset_to_inventory response format | 34 |
| Figure 40. | Reset_to_inventory frame exchange between reader and SRI512 | 34 |
| Figure 41. | Read_block request format. | 35 |
| Figure 42. | Read_block response format | 35 |
| Figure 43. | Read_block frame exchange between reader and SRI512 | 35 |
| Figure 44. | Write_block request format. | 36 |
| Figure 45. | Write_block response format | 36 |
| Figure 46. | Write_block frame exchange between reader and SRI512 | 37 |
| Figure 47. | Get_UID request format | 37 |
| Figure 48. | Get_UID response format. | 37 |

| | | |
|------------|---|----|
| Figure 49. | 64-bit unique identifier of the SRI512 | 38 |
| Figure 50. | Get_UID frame exchange between reader and SRI512 | 38 |
| Figure 51. | SRI512 synchronous timing, transmit and receive | 41 |
| Figure 52. | Initiate frame exchange between reader and SRI512 | 44 |
| Figure 53. | Pcall16 frame exchange between reader and SRI512 | 44 |
| Figure 54. | Slot_marker frame exchange between reader and SRI512 | 44 |
| Figure 55. | Select frame exchange between reader and SRI512 | 44 |
| Figure 56. | Completion frame exchange between reader and SRI512 | 44 |
| Figure 57. | Reset_to_inventory frame exchange between reader and SRI512 | 45 |
| Figure 58. | Read_block frame exchange between reader and SRI512 | 45 |
| Figure 59. | Write_block frame exchange between reader and SRI512 | 45 |
| Figure 60. | Get_UID frame exchange between reader and SRI512 | 45 |

1 Description

The SRI512 is a contactless memory, powered by an externally transmitted radio wave. It contains a 512-bit user EEPROM fabricated with STMicroelectronics CMOS technology. The memory is organized as 16 blocks of 32 bits. The SRI512 is accessed via the 13.56 MHz carrier. Incoming data are demodulated and decoded from the received amplitude shift keying (ASK) modulation signal and outgoing data are generated by load variation using bit phase shift keying (BPSK) coding of a 847 kHz subcarrier. The received ASK wave is 10% modulated. The data transfer rate between the SRI512 and the reader is 106 Kbit/s in both reception and emission modes.

The SRI512 follows the ISO 14443-2 Type B recommendation for the radio-frequency power and signal interface.

Figure 1. Logic diagram

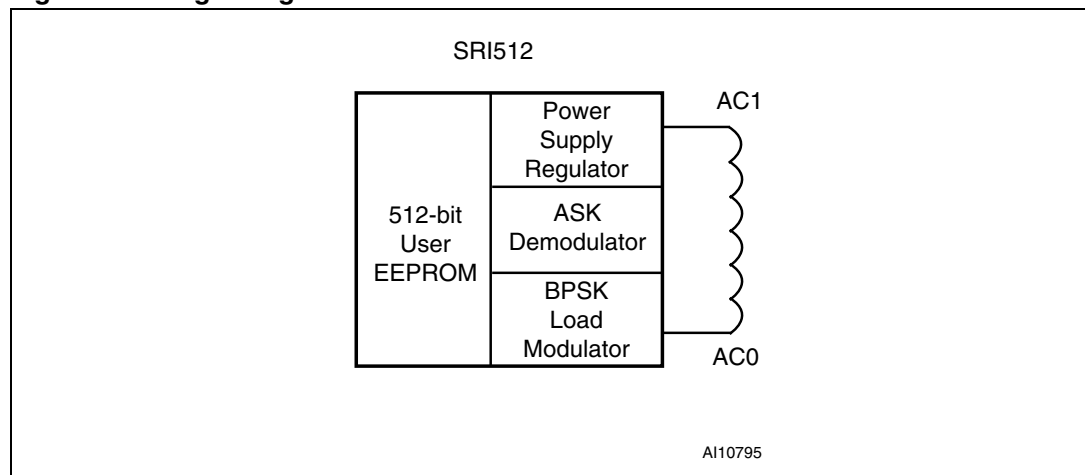

The SRI512 is specifically designed for short range applications that need re-usable products. The SRI512 includes an anticollision mechanism that allows it to detect and select tags present at the same time within range of the reader. Using the STMicroelectronics single chip coupler, CRX14, it is easy to design a reader and build a contactless system.

Table 1. Signal names

| Signal name | Description |
|-------------|--------------|
| AC1 | Antenna coil |
| AC0 | Antenna coil |

The SRI512 contactless EEPROM can be randomly read and written in block mode (each block containing 32 bits). The instruction set includes the following nine commands:

- Read_block
- Write_block
- Initiate
- Pcall16
- Slot_marker
- Select
- Completion
- Reset_to_inventory
- Get_UID

The SRI512 memory is organized in three areas, as described in [Table 3](#). The first area is a resettable OTP (one-time programmable) area in which bits can only be switched from 1 to 0. Using a special command, it is possible to erase all bits of this area to 1.

The second area provides two 32-bit binary counters that can only be decremented from FFFF FFFFh to 0000 0000h, and gives a capacity of 4,294,967,296 units per counter.

The last area is the EEPROM memory. It is accessible by block of 32 bits and includes an auto-erase cycle during each Write_block command.

Figure 2. Die floor plan

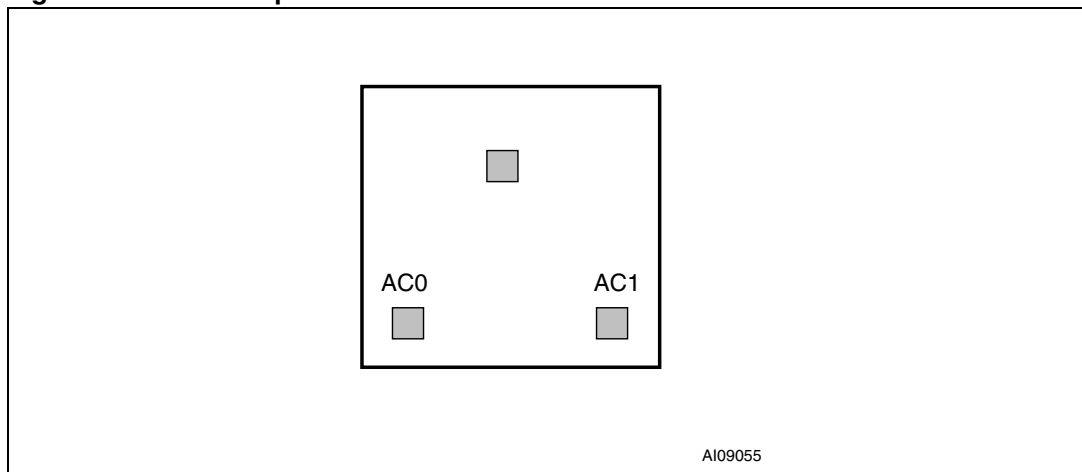

2 Signal description

2.1 AC1, AC0

The pads for the Antenna Coil. AC1 and AC0 must be directly bonded to the antenna.

3 Data transfer

3.1 Input data transfer from the reader to the SRI512 (request frame)

The reader must generate a 13.56 MHz sinusoidal carrier frequency at its antenna, with enough energy to “remote-power” the memory. The energy received at the SRI512’s antenna is transformed into a supply voltage by a regulator, and into data bits by the ASK demodulator. For the SRI512 to decode correctly the information it receives, the reader must 10% amplitude-modulate the 13.56 MHz wave before sending it to the SRI512. This is represented in *Figure 3*. The data transfer rate is 106 Kbits/s.

Figure 3. 10% ASK modulation of the received wave

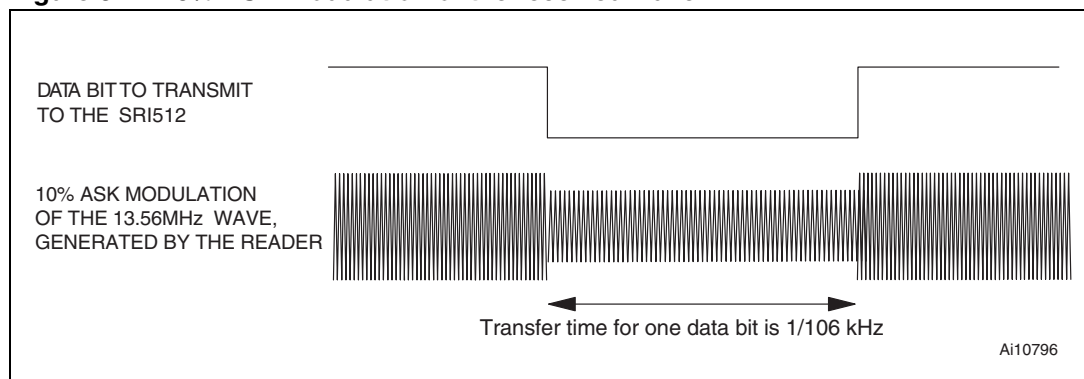

3.1.1 Character transmission format for request frame

The SRI512 transmits and receives data bytes as 10-bit characters, with the least significant bit (b_0) transmitted first, as shown in *Figure 4*. Each bit duration, an ETU (elementary time unit), is equal to 9.44 μ s (1/106 kHz).

These characters, framed by a start of frame (SOF) and an end of frame (EOF), are put together to form a command frame as shown in *Figure 10*. A frame includes an SOF, commands, addresses, data, a CRC and an EOF as defined in the ISO 14443-3 Type B Standard. If an error is detected during data transfer, the SRI512 does not execute the command, but it does not generate an error frame.

Figure 4. SRI512 request frame character format

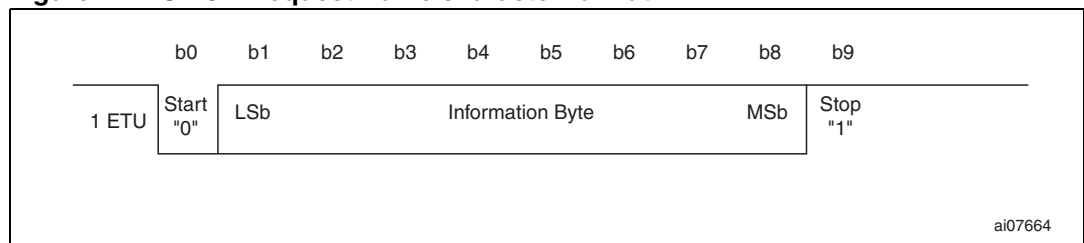

Table 2. Bit description

| Bit | Description | Value |
|----------------------------------|--|---|
| b ₀ | Start bit used to synchronize the transmission | b ₀ = 0 |
| b ₁ to b ₈ | Information byte (command, address or data) | The information byte is sent with the least significant bit first |
| b ₉ | Stop bit used to indicate the end of a character | b ₉ = 1 |

3.1.2 Request start of frame

The SOF described in [Figure 5](#) is composed of:

- one falling edge,
- followed by 10 ETUs at logic-0,
- followed by a single rising edge,
- followed by at least 2 ETUs (and at most 3) at logic-1.

Figure 5. Request start of frame

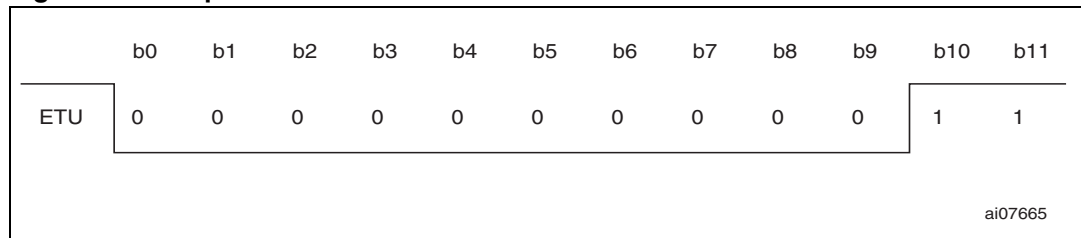

3.1.3 Request end of frame

The EOF shown in [Figure 6](#) is composed of:

- one falling edge,
- followed by 10 ETUs at logic-0,
- followed by a single rising edge.

Figure 6. Request end of frame

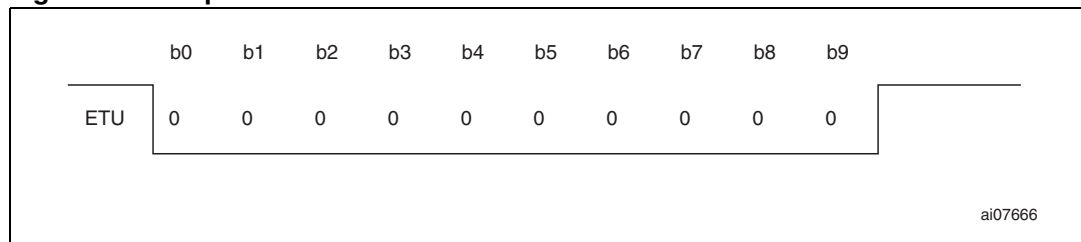

3.2 Output data transfer from the SRI512 to the reader (answer frame)

The data bits issued by the SRI512 use back-scattering. Back-scattering is obtained by modifying the SRI512 current consumption at the antenna (load modulation). The load modulation causes a variation at the reader antenna by inductive coupling. With appropriate detector circuitry, the reader is able to pick up information from the SRI512. To improve load-modulation detection, data is transmitted using a BPSK encoded, 847 kHz subcarrier frequency f_s as shown in *Figure 7*, and as specified in the ISO 14443-2 Type B Standard.

Figure 7. Wave transmitted using BPSK subcarrier modulation

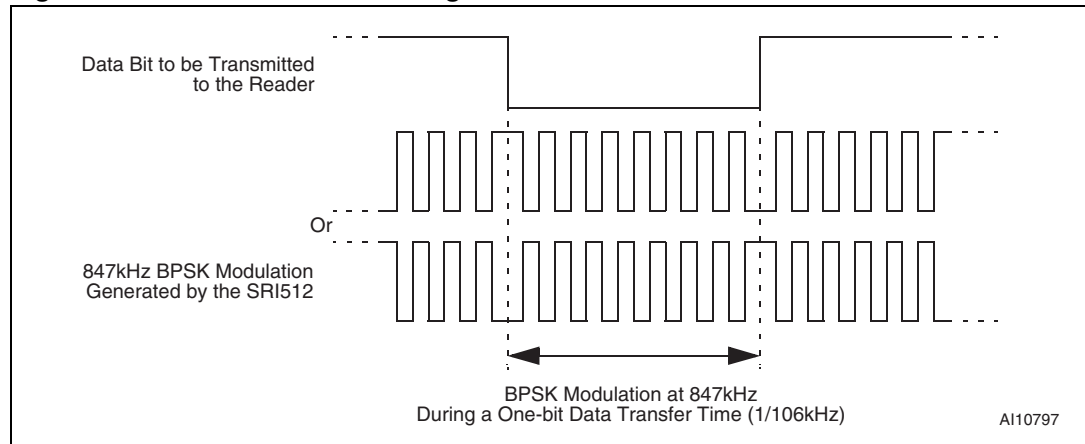

3.2.1 Character transmission format for answer frame

The character format is the same as for input data transfer (*Figure 4*). The transmitted frames are made up of an SOF, data, a CRC and an EOF (*Figure 10*). As with an input data transfer, if an error occurs, the reader does not issue an error code to the SRI512, but it should be able to detect it and manage the situation. The data transfer rate is 106 Kbits/second.

3.2.2 Answer start of frame

The SOF described in *Figure 8* is composed of:

- followed by 10 ETUs at logic-0
- followed by 2 ETUs at logic-1

Figure 8. Answer start of frame

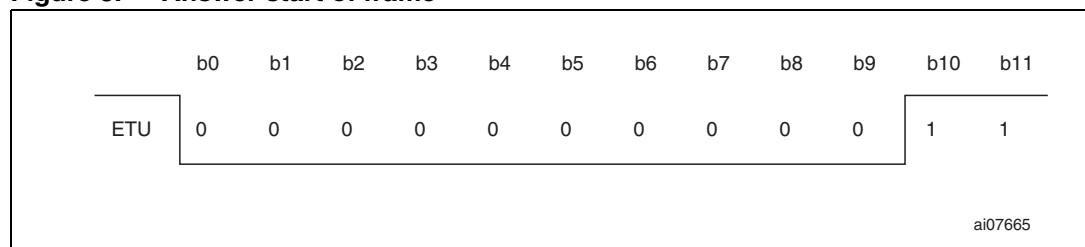

3.2.3 Answer end of frame

The EOF shown in *Figure 9* is composed of:

- followed by 10 ETUs at logic-0,
- followed by 2 ETUs at logic-1.

Figure 9. Answer end of frame

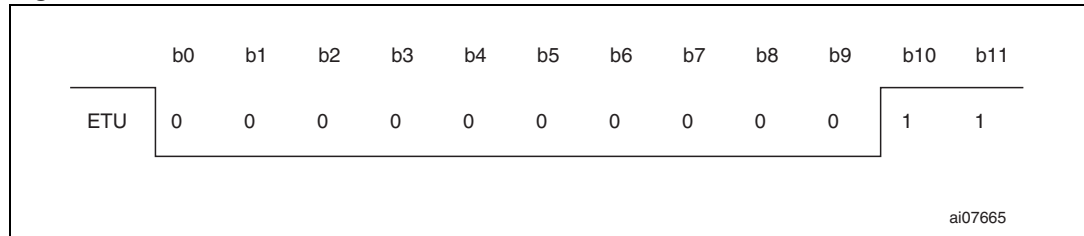

3.3 Transmission frame

Between the request data transfer and the answer data transfer, all ASK and BPSK modulations are suspended for a minimum time of $t_0 = 128/f_S$. This delay allows the reader to switch from Transmission to Reception mode. It is repeated after each frame. After t_0 , the 13.56 MHz carrier frequency is modulated by the SRI512 at 847 kHz for a period of $t_1 = 128/f_S$ to allow the reader to synchronize. After t_1 , the first phase transition generated by the SRI512 forms the start bit ('0') of the answer SOF. After the falling edge of the answer EOF, the reader waits a minimum time, t_2 , before sending a new request frame to the SRI512.

Figure 10. Example of a complete transmission frame

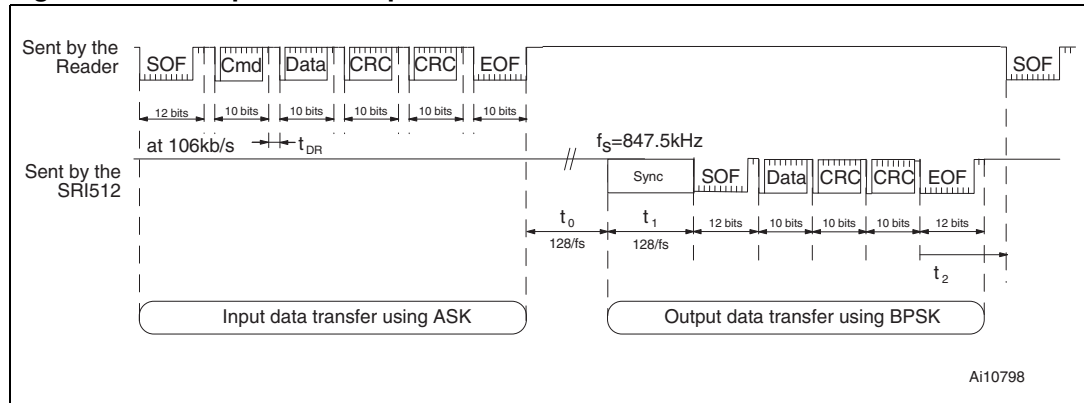

3.4 CRC

The 16-bit CRC used by the SRI512 is generated in compliance with the ISO14443 Type B recommendation. For further information, please see [Appendix A](#). The initial register contents are all 1's: FFFFh.

The two-byte CRC is present in every request and in every answer frame, before the EOF. The CRC is calculated on all the bytes between SOF (not included) and the CRC field.

Upon reception of a request from a reader, the SRI512 verifies that the CRC value is valid. If it is invalid, the SRI512 discards the frame and does not answer the reader.

Upon reception of an answer from the SRI512, the reader should verify the validity of the CRC. In case of error, the actions to be taken are the reader designer's responsibility.

The CRC is transmitted with the least significant byte first and each byte is transmitted with the least significant bit first.

Figure 11. CRC transmission rules

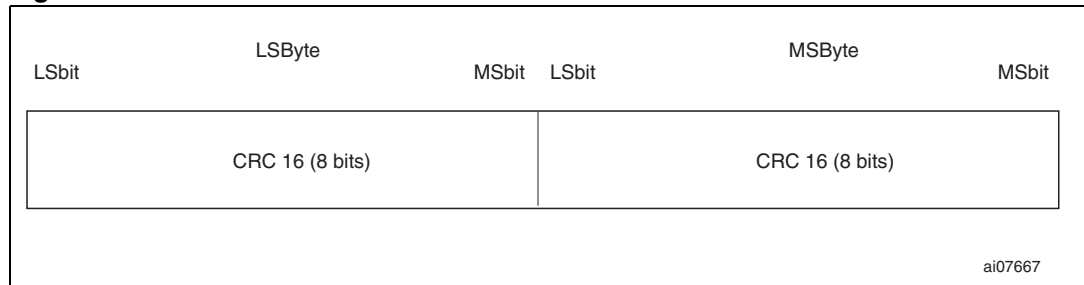

4 Memory mapping

The SRI512 is organized as 16 blocks of 32 bits as shown in [Table 3](#). All blocks are accessible by the Read_block command. Depending on the write access, they can be updated by the Write_block command. A Write_block updates all the 32 bits of the block.

Table 3. SRI512 memory mapping

| Block Addr | Msb b ₃₁ | 32-bit block | | | | Lsb b ₀ | Description |
|------------|------------------------|------------------------|-----------------|-----------------|-------------------------------|-----------------------|---------------------|
| | | b ₁₆ | b ₁₅ | b ₁₄ | b ₈ b ₇ | | |
| 0 | | 32 bits Boolean area | | | | | Resettable OTP bits |
| 1 | | 32 bits Boolean area | | | | | |
| 2 | | 32 bits Boolean area | | | | | |
| 3 | | 32 bits Boolean area | | | | | |
| 4 | | 32 bits Boolean area | | | | | |
| 5 | | 32 bits binary counter | | | | | Count down Counter |
| 6 | | 32 bits binary counter | | | | | |
| 7 | | User area | | | | | Lockable EEPROM |
| 8 | | User area | | | | | |
| 9 | | User area | | | | | |
| 10 | | User area | | | | | |
| 11 | | User area | | | | | |
| 12 | | User area | | | | | |
| 13 | | User area | | | | | |
| 14 | | User area | | | | | |
| 15 | | User area | | | | | |
| 255 | | OTP_Lock_Reg | 0 | ST Reserved | Fixed Chip_ID (Option) | | System OTP bits |
| UID0 | | 64 bits UID area | | | | | ROM |
| UID1 | | | | | | | |

4.1 Resettable OTP area

This area contains five individual 32-bit Boolean words (see [Figure 12](#) for a map of the area). A Write_block command will not erase the previous contents of the block as the write cycle is not preceded by an auto-erase cycle. This feature can be used to reset selected bits from 1 to 0. All bits previously at 0 remain unchanged. When the 32 bits of a block are all at 0, the block is empty, and cannot be updated any more. See [Figure 13](#) and [Figure 14](#) for examples of the result of the Write_block command in the resettable OTP area.

Figure 12. Resettable OTP area (addresses 0 to 4)

| Block Address | MSb b31 | 32-bit Block b16 b15 b14 | b8 b7 | LSb b0 | Description |
|---------------|---------|-----------------------------|-------|--------|--------------------|
| 0 | | 32-bit Boolean Area | | | Resettable OTP Bit |
| 1 | | 32-bit Boolean Area | | | |
| 2 | | 32-bit Boolean Area | | | |
| 3 | | 32-bit Boolean Area | | | |
| 4 | | 32-bit Boolean Area | | | |

ai12381

Figure 13. Write_block update in standard mode (binary format)

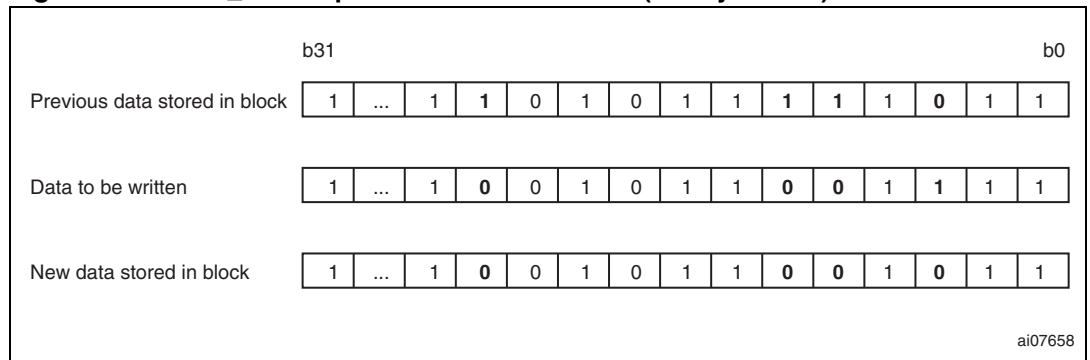

The five 32-bit blocks making up the Resettable OTP area can be erased in one go by adding an auto-erase cycle to the Write_block command. An auto-erase cycle is added each time the SRI512 detects a Reload command. The Reload command is implemented through a specific update of the 32-bit binary counter located at block address 6 (see [Section 4.2: 32-bit binary counters](#) for details).

Figure 14. Write_block update in reload mode (binary format)

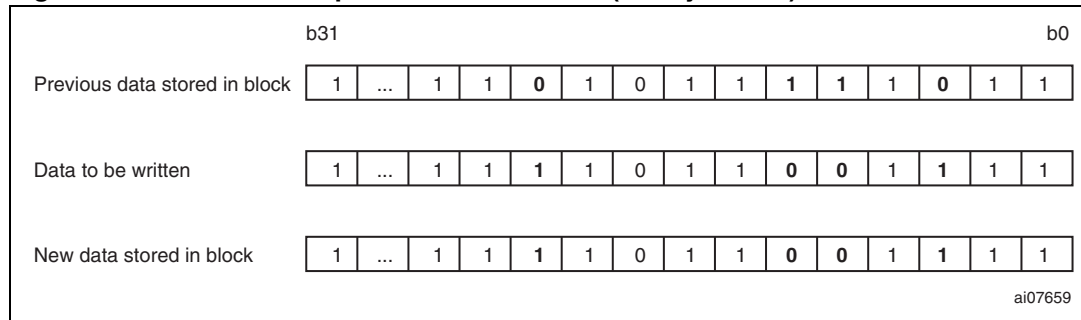

4.2 32-bit binary counters

The two 32-bit binary counters located at block addresses 5 and 6, respectively, are used to count down from 2^{32} (4096 million) to 0. The SRI512 uses dedicated logic that only allows the update of a counter if the new value is lower than the previous one. This feature allows the application to count down by steps of 1 or more. The initial value in the counter is FFFF FFFFh. When the value displayed is 0000 0000h, the counter is empty and cannot be reloaded. The counter is updated by issuing the Write_block command to block address 5 or 6, depending on which counter is to be updated. The Write_block command writes the new 32-bit value to the counter block address. *Figure 16* shows examples of how the counters operate.

The counter programming cycles are protected by automated antitearing logic. This function allows the counter value to be protected in case of power down within the programming cycle. In case of power down, the counter value is not updated and the previous value continues to be stored.

Blocks 5 and 6 can be write-protected using the OTP_Lock_Reg bits (block 255). Once a block has been protected, its contents cannot be modified. A protected counter block behaves like a ROM block.

Figure 15. Binary counter (addresses 5 to 6)

| Block Address | MSb b31 | 32-bit Block b16 b15 b14 b8 b7 | LSb b0 | Description |
|---------------|------------|--|-----------|--------------------|
| 5 | | 32-bit Binary Counter | | Count down Counter |
| 6 | | 32-bit Binary Counter | | |

ai12384

Figure 16. Count down example (binary format)

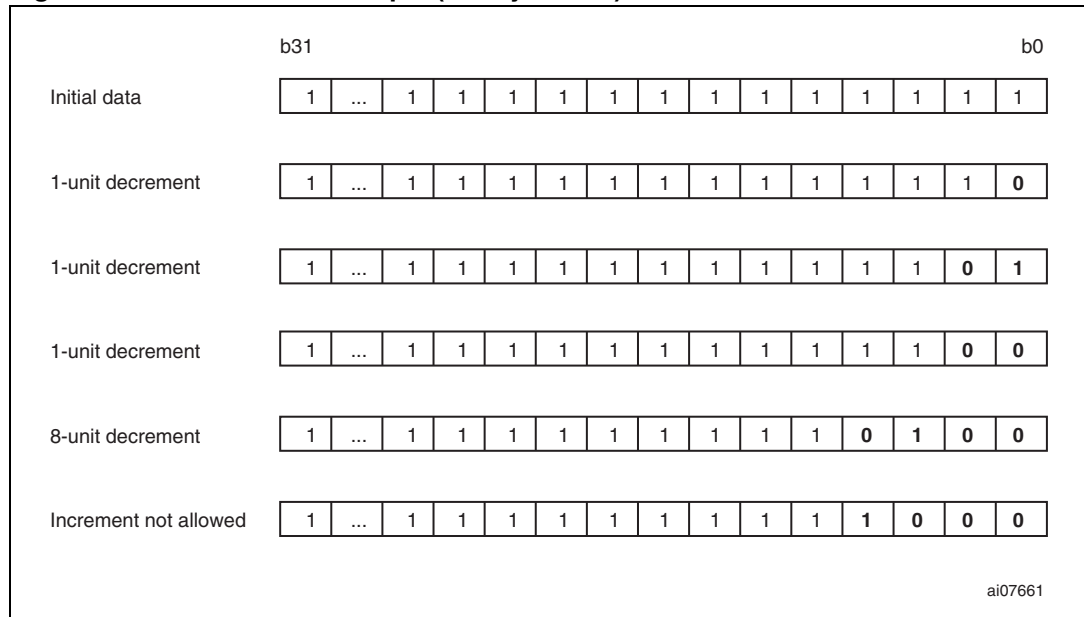

The counter with block address 6 controls the Reload command used to reset the resettable OTP area (addresses 0 to 4). Bits b_{31} to b_{21} act as an 11-bit Reload counter; whenever one of these 11 bits is updated, the SRI512 detects the change and adds an Erase cycle to the Write_block command for locations 0 to 4 (see [Section 4.1: Resettable OTP area](#)). The Erase cycle remains active until a Power-off or a Select command is issued. The SRI512's resettable OTP area can be reloaded up to 2,047 times ($2^{11}-1$).

4.3 EEPROM area

The 9 blocks between addresses 7 and 15 are EEPROM blocks of 32 bits each (36 bytes in total). (See [Figure 17](#) for a map of the area.) These blocks can be accessed using the Read_block and Write_block commands. The Write_block command for the EEPROM area always includes an auto-erase cycle prior to the write cycle.

Blocks 7 to 15 can be write-protected. Write access is controlled by the 9 bits of the OTP_Lock_Reg located at block address 255 (see [Section 4.4.1: OTP_Lock_Reg](#) for details). Once protected, these blocks (7 to 15) cannot be unprotected

Figure 17. EEPROM (addresses 7 to 15)

| Block address | MSb b31 | 32-bit block b16 b15 b14 b8 b7 | LSb b0 | Description |
|---------------|------------|--|-----------|--------------------|
| 7 | | User area | | Lockable EEPROM |
| 8 | | User area | | |
| 9 | | User area | | |
| 10 | | User area | | |
| 11 | | User area | | |
| 12 | | User area | | |
| 13 | | User area | | |
| 14 | | User area | | |
| 15 | | User area | | |

Ai12383b

4.4 System area

This area is used to modify the settings of the SRI512. It contains 3 registers: OTP_Lock_Reg, Fixed Chip_ID and ST Reserved. See [Figure 18](#) for a map of this area.

A Write_block command in this area will not erase the previous contents. Selected bits can thus be set from 1 to 0. All bits previously at 0 remain unchanged. Once all the 32 bits of a block are at 0, the block is empty and cannot be updated any more.

Figure 18. System area

| Block Address | 32-bit Block | | | | Description |
|---------------|--------------|-----|-------------|------------------------|-------------|
| | MSb b31 | b16 | b15 | LSb b0 | |
| 255 | OTP_Lock_Reg | 0 | ST Reserved | Fixed Chip_ID (Option) | OTP |

ai12374b

4.4.1 OTP_Lock_Reg

The 16 bits, b31 to b16, of the System area (block address 255) are used as OTP_Lock_Reg bits in the SRI512. They control the write access to the 16 blocks 0 to 15 as follows:

- When b16 is at 0, block 0 is write-protected
- When b17 is at 0, block 1 is write-protected
- When b18 is at 0, block 2 is write-protected
- When b19 is at 0, block 3 is write-protected
- When b20 is at 0, block 4 is write-protected
- When b21 is at 0, block 5 is write-protected
- When b22 is at 0, block 6 is write-protected
- When b23 is at 0, block 7 is write-protected
- When b24 is at 0, block 8 is write-protected
- When b25 is at 0, block 9 is write-protected
- When b26 is at 0, block 10 is write-protected
- When b27 is at 0, block 11 is write-protected
- When b28 is at 0, block 12 is write-protected
- When b29 is at 0, block 13 is write-protected
- When b30 is at 0, block 14 is write-protected
- When b31 is at 0, block 15 is write-protected.

The OTP_Lock_Reg bits cannot be erased. Once write-protected, the blocks behave like ROM blocks and cannot be unprotected. After any modification of the OTP_Lock_Reg bits, it is necessary to send a Select command with a valid Chip_ID to the SRI512 in order to load the block write protection into the logic.

4.4.2 Fixed Chip_ID (option)

The SRI512 is provided with an anticollision feature based on a random 8-bit Chip_ID. Prior to selecting an SRI512, an anticollision sequence has to be run to search for the Chip_ID of the SRI512. This is a very flexible feature, however the searching loop requires time to run.

For some applications, much time could be saved by knowing the value of the SRI512 Chip_ID beforehand, so that the SRI512 can be identified and selected directly without having to run an anticollision sequence. This is why the SRI512 was designed with an optional mask setting used to program a fixed 8-bit Chip_ID to bits b_7 to b_0 of the system area. When the fixed Chip_ID option is used, the random Chip_ID function is disabled.

5 SRI512 operation

All commands, data and CRC are transmitted to the SRI512 as 10-bit characters using ASK modulation. The start bit of the 10 bits, b_0 , is sent first. The command frame received by the SRI512 at the antenna is demodulated by the 10% ASK demodulator, and decoded by the internal logic. Prior to any operation, the SRI512 must have been selected by a Select command. Each frame transmitted to the SRI512 must start with a start of frame, followed by one or more data characters, two CRC bytes and the final end of frame. When an invalid frame is decoded by the SRI512 (wrong command or CRC error), the memory does not return any error code.

When a valid frame is received, the SRI512 may have to return data to the reader. In this case, data is returned using BPSK encoding, in the form of 10-bit characters framed by an SOF and an EOF. The transfer is ended by the SRI512 sending the 2 CRC bytes and the EOF.

6 SRI512 states

The SRI512 can be switched into different states. Depending on the current state of the SRI512, its logic will only answer to specific commands. These states are mainly used during the anticollision sequence, to identify and to access the SRI512 in a very short time. The SRI512 provides 6 different states, as described in the following paragraphs and in [Figure 19](#).

6.1 Power-off state

The SRI512 is in Power-off state when the electromagnetic field around the tag is not strong enough. In this state, the SRI512 does not respond to any command.

6.2 Ready state

When the electromagnetic field is strong enough, the SRI512 enters the Ready state. After Power-up, the Chip_ID is initialized with a random value. The whole logic is reset and remains in this state until an Initiate() command is issued. Any other command will be ignored by the SRI512.

6.3 Inventory state

The SRI512 switches from the Ready to the Inventory state after an Initiate() command has been issued. In Inventory state, the SRI512 will respond to any anticollision commands: Initiate(), Pcall16() and Slot_marker(), and then remain in the Inventory state. It will switch to the Selected state after a Select(Chip_ID) command is issued, if the Chip_ID in the command matches its own. If not, it will remain in Inventory state.

6.4 Selected state

In Selected state, the SRI512 is active and responds to all Read_block(), Write_block(), and Get_UID() commands. When an SRI512 has entered the Selected state, it no longer responds to anticollision commands. So that the reader can access another tag, the SRI512 can be switched to the Deselected state by sending a Select(Chip_ID2) with a Chip_ID that does not match its own, or it can be placed in Deactivated state by issuing a Completion() command. Only one SRI512 can be in Selected state at a time.

6.5 Deselected state

Once the SRI512 is in Deselected state, only a Select(Chip_ID) command with a Chip_ID matching its own can switch it back to Selected state. All other commands are ignored.

6.6 Deactivated state

When in this state, the SRI512 can only be turned off. All commands are ignored.

Figure 19. State transition diagram

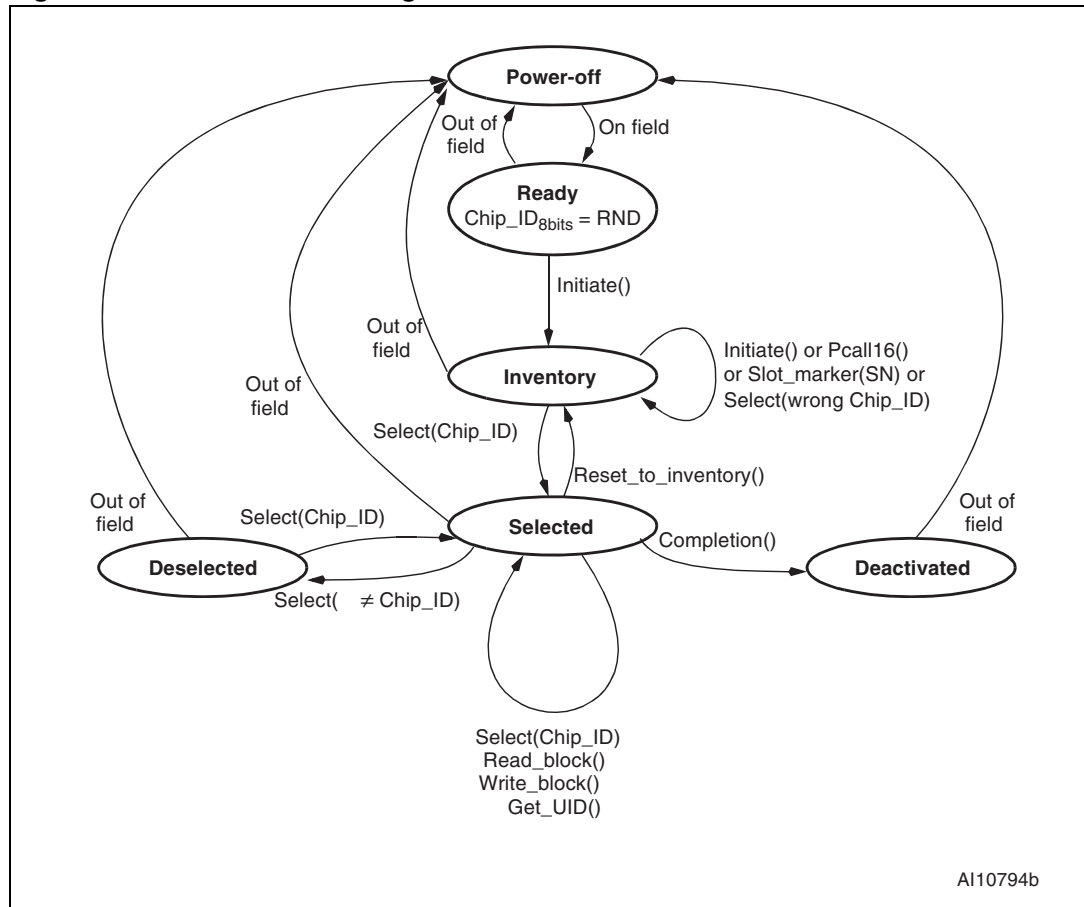

AI10794b

7 Anticollision

The SRI512 provides an anticollision mechanism that searches for the Chip_ID of each device that is present in the reader field range. When known, the Chip_ID is used to select an SRI512 individually, and access its memory. The anticollision sequence is managed by the reader through a set of commands described in [Section 5: SRI512 operation](#):

- Initiate()
- Pcall16()
- Slot_marker().

The reader is the master of the communication with one or more SRI512 device(s). It initiates the tag communication activity by issuing an Initiate(), Pcall16() or Slot_marker() command to prompt the SRI512 to answer. During the anticollision sequence, it might happen that two or more SRI512 devices respond simultaneously, so causing a collision. The command set allows the reader to handle the sequence, to separate SRI512 transmissions into different time slots. Once the anticollision sequence has completed, SRI512 communication is fully under the control of the reader, allowing only one SRI512 to transmit at a time.

The Anticollision scheme is based on the definition of time slots during which the SRI512 devices are invited to answer with minimum identification data: the Chip_ID. The number of slots is fixed at 16 for the Pcall16() command. For the Initiate() command, there is no slot and the SRI512 answers after the command is issued. SRI512 devices are allowed to answer only once during the anticollision sequence. Consequently, even if there are several SRI512 devices present in the reader field, there will probably be a slot in which only one SRI512 answers, allowing the reader to capture its Chip_ID. Using the Chip_ID, the reader can then establish a communication channel with the identified SRI512. The purpose of the anticollision sequence is to allow the reader to select one SRI512 at a time.

The SRI512 is given an 8-bit Chip_ID value used by the reader to select only one among up to 256 tags present within its field range. The Chip_ID is initialized with a random value during the Ready state, or after an Initiate() command in the Inventory state.

The four least significant bits (b₀ to b₃) of the Chip_ID are also known as the Chip_slot_number. This 4-bit value is used by the Pcall16() and Slot_marker() commands during the anticollision sequence in the Inventory state.

Figure 20. SRI512 Chip_ID description

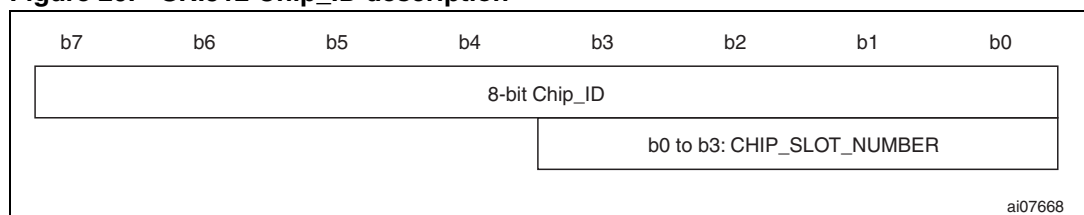

Each time the SRI512 receives a Pcall16() command, the Chip_slot_number is given a new 4-bit random value. If the new value is 0000_b, the SRI512 returns its whole 8-bit Chip_ID in its answer to the Pcall16() command. The Pcall16() command is also used to define the slot number 0 of the anticollision sequence. When the SRI512 receives the Slot_marker(SN) command, it compares its Chip_slot_number with the Slot_number parameter (SN). If they match, the SRI512 returns its Chip_ID as a response to the command. If they do not, the SRI512 does not answer. The Slot_marker(SN) command is used to define all the anticollision slot numbers from 1 to 15.

Figure 21. Description of a possible anticollision sequence

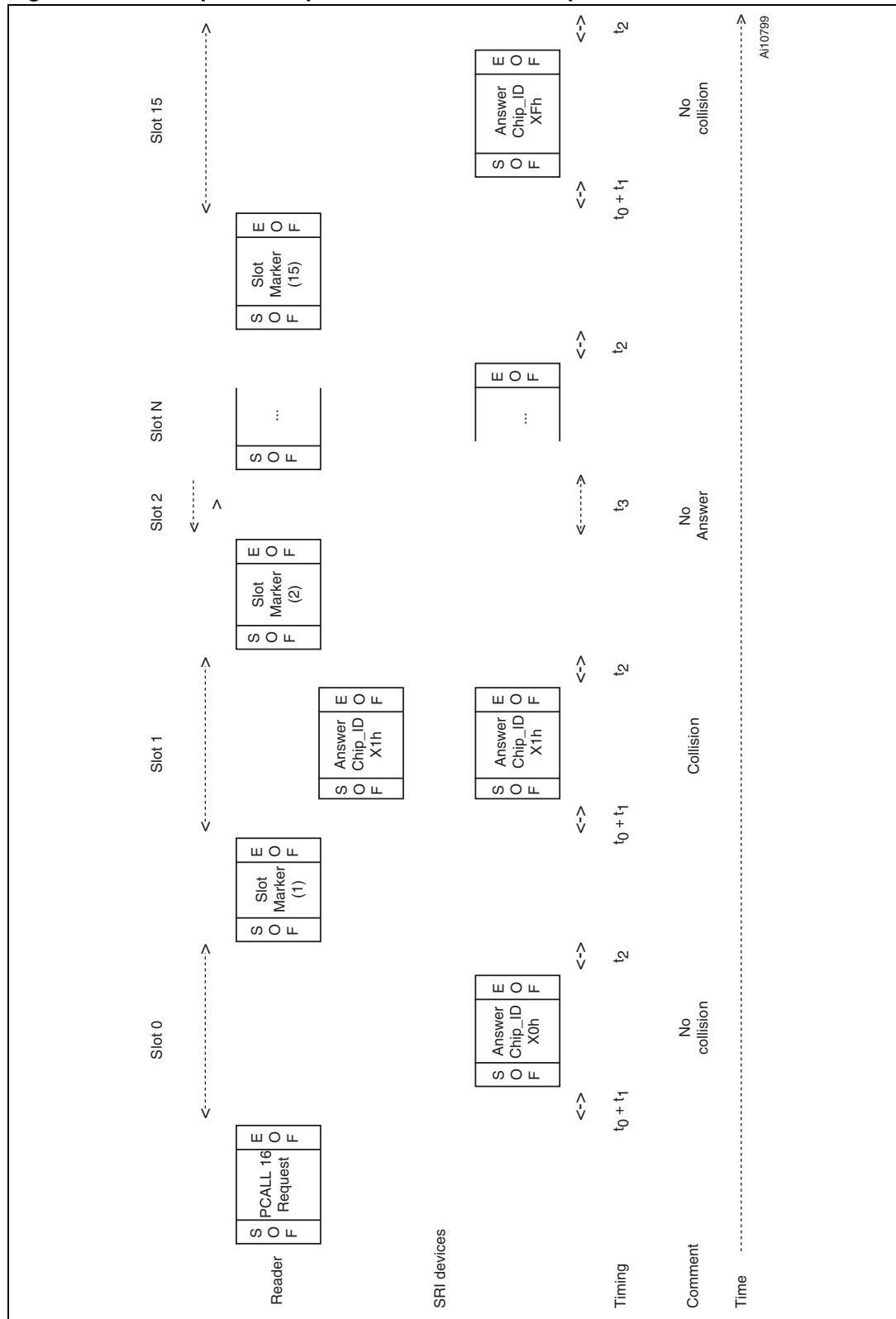

1. The value X in the answer Chip_ID means a random hexadecimal character from 0 to F.

7.1 Description of an anticollision sequence

The anticollision sequence is initiated by the Initiate() command which triggers all the SRI512 devices that are present in the reader field range, and that are in Inventory state. Only SRI512 devices in Inventory state will respond to the Pcall16() and Slot_marker(SN) anticollision commands.

A new SRI512 introduced in the field range during the anticollision sequence will not be taken into account as it will not respond to the Pcall16() or Slot_marker(SN) command (Ready state). To be considered during the anticollision sequence, it must have received the Initiate() command and entered the Inventory state.

Table 4 shows the elements of a standard anticollision sequence. (See Figure 22 for an example.)

Table 4. Standard anticollision sequence

| | | |
|---------|---------|---|
| Step 1 | Init: | Send Initiate(). – If no answer is detected, go to step1. – If only 1 answer is detected, select and access the SRI512. After accessing the SRI512, deselect the tag and go to step1. – If a collision (many answers) is detected, go to step2. |
| Step 2 | Slot 0 | Send Pcall16(). – If no answer or collision is detected, go to step3. – If 1 answer is detected, store the Chip_ID, Send Select() and go to step3. |
| Step 3 | Slot 1 | Send Slot_marker(1). – If no answer or collision is detected, go to step4. – If 1 answer is detected, store the Chip_ID, Send Select() and go to step4. |
| Step 4 | Slot 2 | Send Slot_marker(2). – If no answer or collision is detected, go to step5. – If 1 answer is detected, store the Chip_ID, Send Select() and go to step5. |
| Step N | Slop N | Send Slot_marker(3 up to 14) ... – If no answer or collision is detected, go to stepN+1. – If 1 answer is detected, store the Chip_ID, Send Select() and go to stepN+1. |
| Step 17 | Slot 15 | Send Slot_marker(15). – If no answer or collision is detected, go to step18. – If 1 answer is detected, store the Chip_ID, Send Select() and go to step18. |
| Step 18 | | All the slots have been generated and the Chip_ID values should be stored into the reader memory. Issue the Select(Chip_ID) command and access each identified SRI512 one by one. After accessing each SRI512, switch them into Deselected or Deactivated state, depending on the application needs. – If collisions were detected between Step2 and Step17, go to Step2. – If no collision was detected between Step2 and Step17, go to Step1. |

After each Slot_marker() command, there may be several, one or no answers from the SRI512 devices. The reader must handle all the cases and store all the Chip_IDs, correctly decoded. At the end of the anticollision sequence, after Slot_marker(15), the reader can start working with one SRI512 by issuing a Select() command containing the desired Chip_ID. If a collision is detected during the anticollision sequence, the reader has to generate a new sequence in order to identify all unidentified SRI512 devices in the field. The anticollision sequence can stop when all SRI512 devices have been identified.

Figure 22. Example of an anticollision sequence

| Command | Tag 1 Chip_ID | Tag 2 Chip_ID | Tag 3 Chip_ID | Tag 4 Chip_ID | Tag 5 Chip_ID | Tag 6 Chip_ID | Tag 7 Chip_ID | Tag 8 Chip_ID | Comments |
|----------------|------------------|------------------|------------------|------------------|------------------|------------------|------------------|------------------|---|
| READY State | 28h | 75h | 40h | 01h | 02h | FEh | A9h | 7Ch | Each tag gets a random Chip_ID |
| INITIATE () | 40h | 13h | 3Fh | 4Ah | 50h | 48h | 52h | 7Ch | Each tag get a new random Chip_ID All tags answer: collisions |
| PCALL16() | 45h | 12h | 30h | 43h | 55h | 43h | 53h | 73h | All CHIP_SLOT_NUMBERS get a new random value Slot0: only one answer |
| SELECT(30h) | | | 30h | | | | | | Tag3 is identified |
| SLOT_MARKER(1) | | | | | | | | | Slot1: no answer |
| SLOT_MARKER(2) | | 12h | | | | | | | Slot2: only one answer |
| SELECT(12h) | | 12h | | | | | | | Tag2 is identified |
| SLOT_MARKER(3) | | | | 43h | | 43h | 53h | 73h | Slot3: collisions |
| SLOT_MARKER(4) | | | | | | | | | Slot4: no answer |
| SLOT_MARKER(5) | 45h | | | | 55h | | | | Slot5: collisions |
| SLOT_MARKER(6) | | | | | | | | | Slot6: no answer |
| SLOT_MARKER(N) | | | | | | | | | SlotN: no answer |
| SLOT_MARKER(F) | | | | | | | | | SlotF: no answer |
| PCALL16() | 40h | | | 41h | 53h | 42h | 50h | 74h | All CHIP_SLOT_NUMBERS get a new random value Slot0: collisions |
| SLOT_MARKER(1) | 40h | | | 41h | | | 50h | | Slot1: only one answer |
| SELECT(41h) | | | | 41h | | | | | Tag4 is identified |
| SLOT_MARKER(2) | | | | | | 42h | | | Slot2: only one answer |
| SELECT(42h) | | | | | | 42h | | | Tag6 is identified |
| SLOT_MARKER(3) | | | | | 53h | | | | Slot3: only one answer |
| SELECT(53h) | | | | | 53h | | | | Tag5 is identified |
| SLOT_MARKER(4) | | | | | | | | 74h | Slot4: only one answer |
| SELECT(74h) | | | | | | | | 74h | Tag8 is identified |
| SLOT_MARKER(N) | | | | | | | | | SlotN: no answer |
| PCALL16() | 41h | | | | | | 50h | | All CHIP_SLOT_NUMBERS get a new random value Slot0: only one answer |
| SELECT(50h) | | | | | | | 50h | | Tag7 is identified |
| SLOT_MARKER(1) | 41h | | | | | | | | Slot1: only one answer but already found for tag4 |
| SLOT_MARKER(N) | | | | | | | | | SlotN: no answer |
| PCALL16() | 43h | | | | | | | | All CHIP_SLOT_NUMBERS get a new random value Slot0: only one answer |
| SLOT_MARKER(3) | 43h | | | | | | | | Slot3: only one answer |
| SELECT(43h) | | | | | | | | 43h | Tag1 is identified |
| | | | | | | | | | All tags are identified |

ai07669

8 SRI512 commands

See the paragraphs below for a detailed description of the Commands available on the SRI512. The commands and their hexadecimal codes are summarized in [Table 5](#). A brief is given in [Appendix B](#).

Table 5. Command code

| Hexadecimal Code | Command |
|------------------|-------------------------|
| 06h-00h | Initiate() |
| 06h-04h | Pcall16() |
| x6h | Slot_marker (SN) |
| 08h | Read_block(Addr) |
| 09h | Write_block(Addr, Data) |
| 0Bh | Get_UID() |
| 0Ch | Reset_to_inventory |
| 0Eh | Select(Chip_ID) |
| 0Fh | Completion() |

8.1 Initiate() command

Command code = 06h - 00h

Initiate() is used to initiate the anticollision sequence of the SRI512. On receiving the Initiate() command, all SRI512 devices in Ready state switch to Inventory state, set a new 8-bit Chip_ID random value, and return their Chip_ID value. This command is useful when only one SRI512 in Ready state is present in the reader field range. It speeds up the Chip_ID search process. The Chip_slot_number is not used during Initiate() command access.

Figure 23. Initiate request format

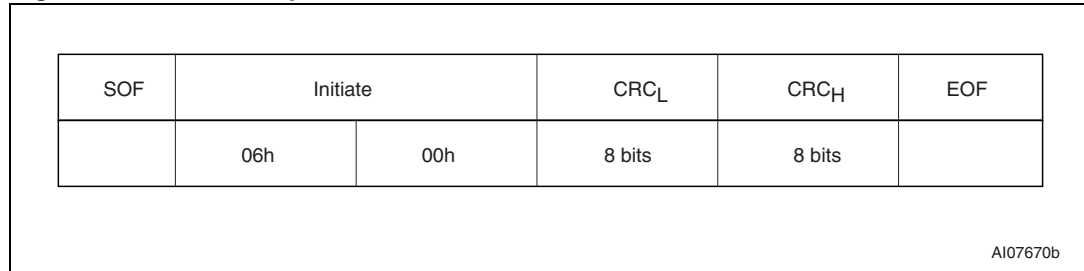

Request parameter:

- No parameter

Figure 24. Initiate response format

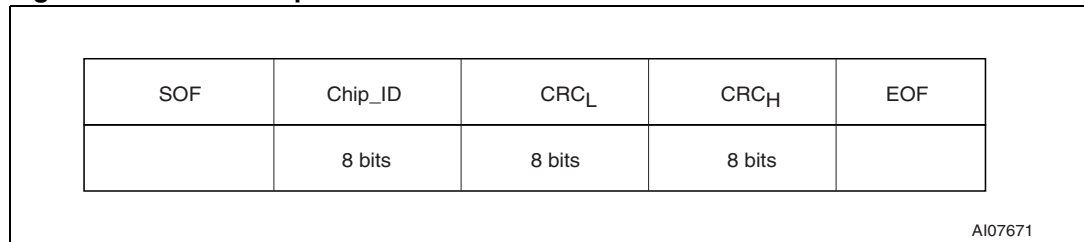

Response parameter:

- Chip_ID of the SRI512

Figure 25. Initiate frame exchange between reader and SRI512

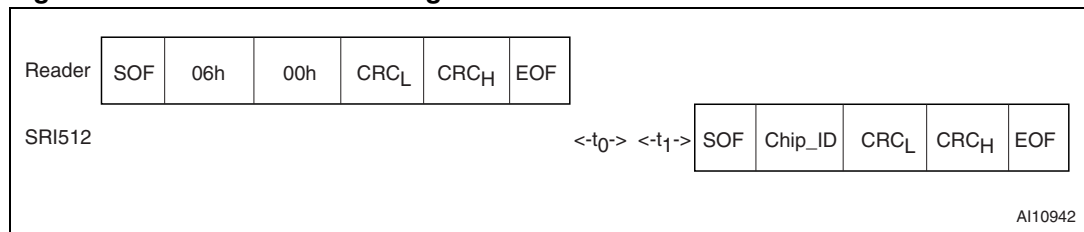

8.3 Slot_marker(SN) command

Command code = x6h

The SRI512 must be in Inventory state to interpret the Slot_marker(SN) command.

The Slot_marker byte code is divided into two parts:

- b₃ to b₀: 4-bit command code with fixed value 6.
- b₇ to b₄: 4 bits known as the Slot_number (SN). They assume a value between 1 and 15. The value 0 is reserved by the Pcall16() command.

On receiving the Slot_marker() command, the SRI512 compares its Chip_slot_number value with the Slot_number value given in the command code. If they match, the SRI512 returns its Chip_ID value. If not, the SRI512 does not send any response.

The Slot_marker() command, used together with the Pcall16() command, allows the reader to search for all the Chip_IDs when there are more than one SRI512 device in Inventory state present in the reader field range.

Figure 29. Slot_marker request format

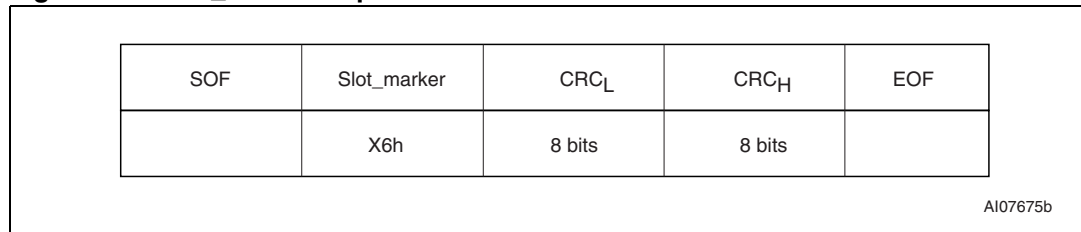

Request parameter:

- x: Slot number

Figure 30. Slot_marker response format

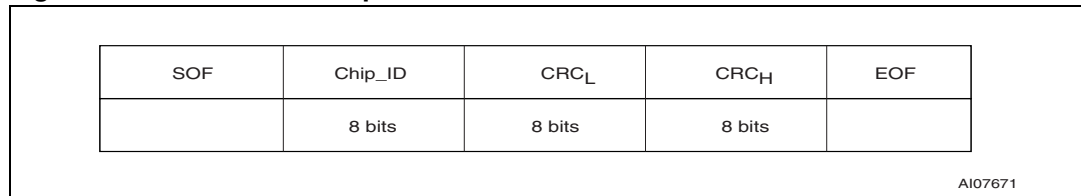

Response parameters:

- Chip_ID of the SRI512

Figure 31. Slot_marker frame exchange between reader and SRI512

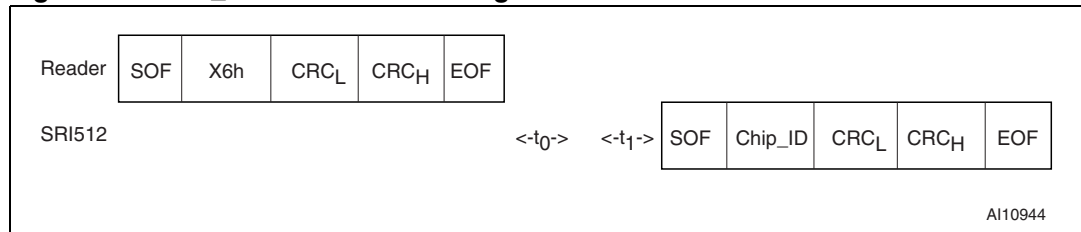

8.5 Completion() command

Command code = 0Fh

On receiving the Completion() command, an SRI512 in Selected state switches to Deactivated state and stops decoding any new commands. The SRI512 is then locked in this state until a complete reset (tag out of the field range). A new SRI512 can thus be accessed through a Select() command without having to remove the previous one from the field. The Completion() command does not generate a response.

All SRI512 devices not in Selected state ignore the Completion() command.

Figure 35. Completion request format

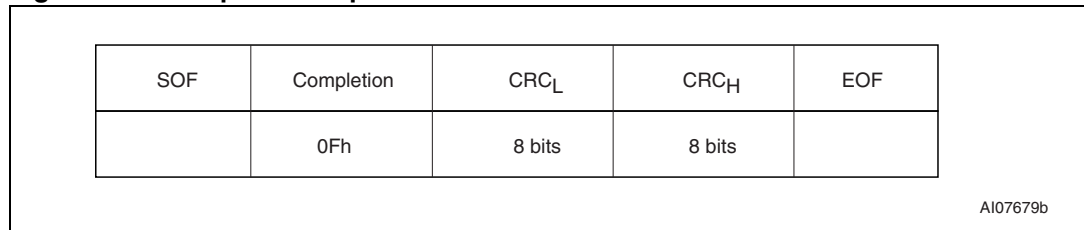

Request parameters:

- No parameter

Figure 36. Completion response format

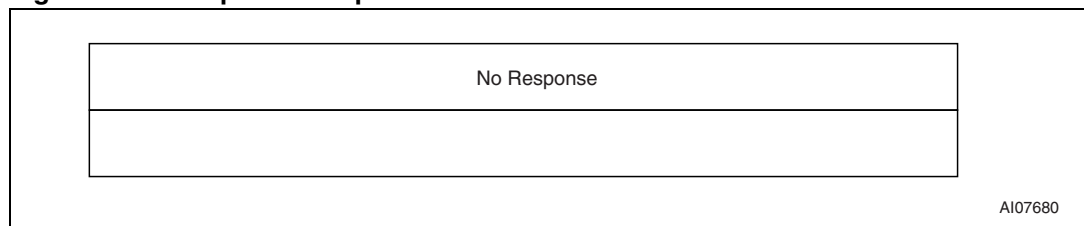
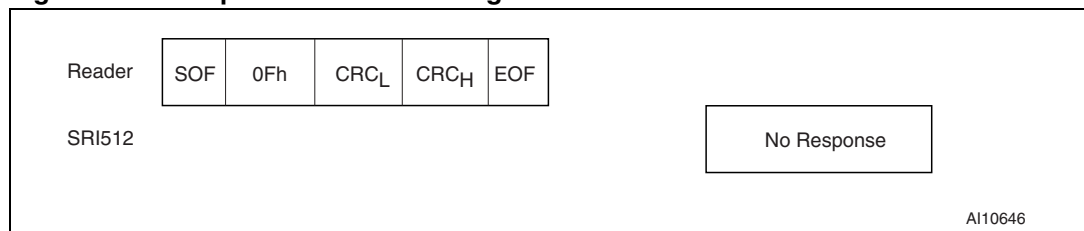

Figure 37. Completion frame exchange between reader and SRI512



8.6 Reset_to_inventory() command

Command code = 0Ch

On receiving the Reset_to_inventory() command, all SRI512 devices in Selected state revert to Inventory state. The concerned SRI512 devices are thus resubmitted to the anticollision sequence. This command is useful when two SRI512 devices with the same 8-bit Chip_ID happen to be in Selected state at the same time. Forcing them to go through the anticollision sequence again allows the reader to generate new Pcall16() commands and so, to set new random Chip_IDs.

The Reset_to_inventory() command does not generate a response.

All SRI512 devices that are not in Selected state ignore the Reset_to_inventory() command.

Figure 38. Reset_to_inventory request format

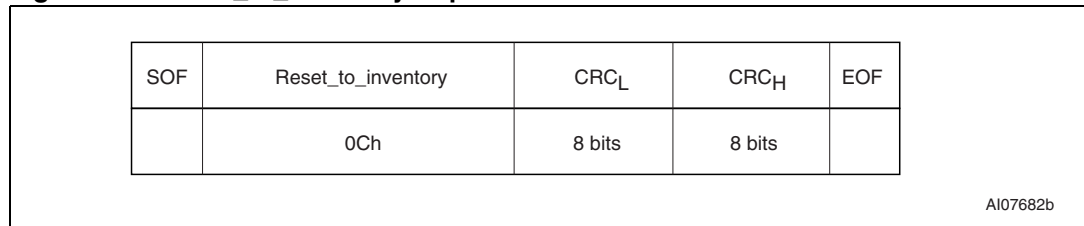

Request parameter:

- No parameter

Figure 39. Reset_to_inventory response format

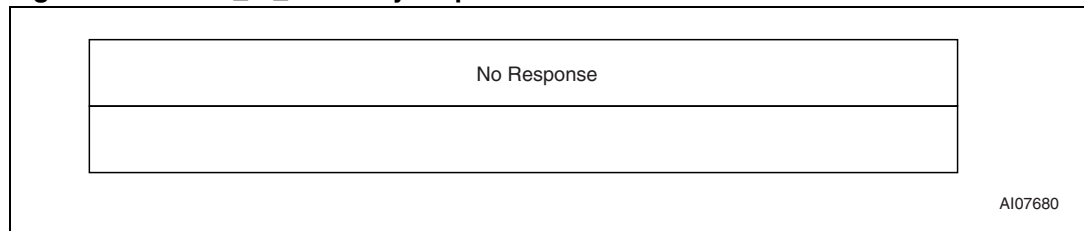
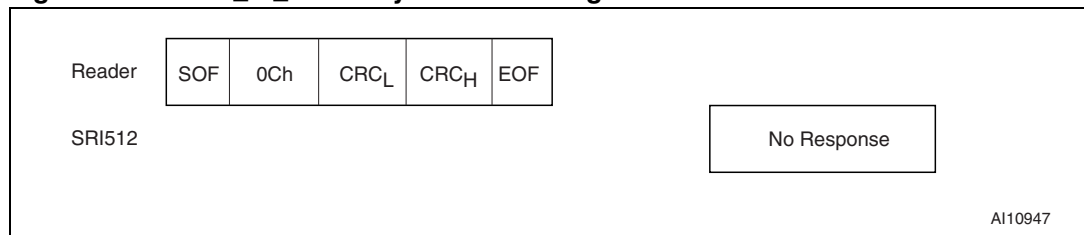

Figure 40. Reset_to_inventory frame exchange between reader and SRI512



8.7 Read_block(Addr) command

Command code = 08h

On receiving the Read_block command, the SRI512 reads the desired block and returns the 4 data bytes contained in the block. Data bytes are transmitted with the Least Significant byte first and each byte is transmitted with the least significant bit first.

The address byte gives access to the 16 blocks of the SRI512 (addresses 0 to 15). Read_block commands issued with a block address above 15 will not be interpreted and the SRI512 will not return any response, except for the System area located at address 255.

The SRI512 must have received a Select() command and be switched to Selected state before any Read_block() command can be accepted. All Read_block() commands sent to the SRI512 before a Select() command is issued are ignored.

Figure 41. Read_block request format

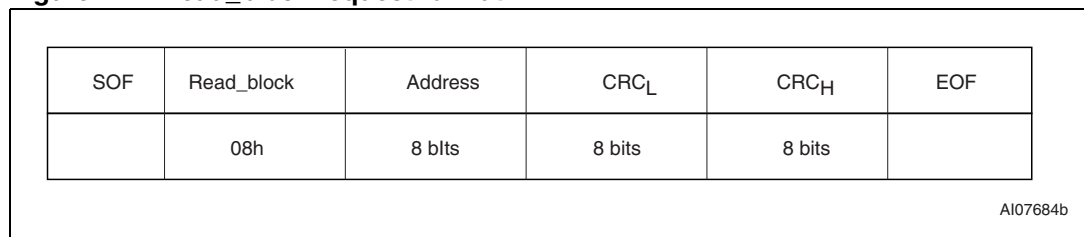

Request parameter:

- Address: block addresses from 0 to 15, or 255

Figure 42. Read_block response format

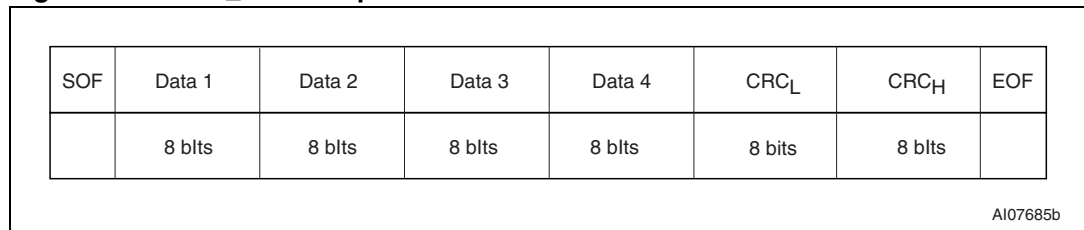

Response parameters:

- Data 1: Less significant data byte
- Data 2: Data byte
- Data 3: Data byte
- Data 4: Most significant data byte

Figure 43. Read_block frame exchange between reader and SRI512

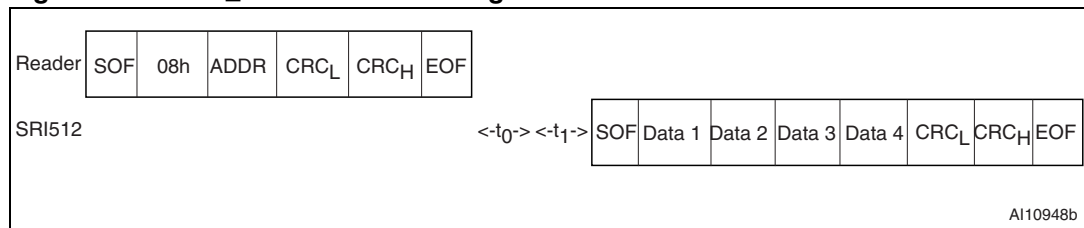

8.8 Write_block (Addr, Data) command

Command code = 09h

On receiving the Write_block command, the SRI512 writes the 4 bytes contained in the command to the addressed block, provided that the block is available and not write-protected. Data bytes are transmitted with the least significant byte first, and each byte is transmitted with the least significant bit first.

The address byte gives access to the 16 blocks of the SRI512 (addresses 0 to 15). Write_block commands issued with a block address above 15 will not be interpreted and the SRI512 will not return any response, except for the System area located at address 255.

The result of the Write_block command is submitted to the addressed block. See the following paragraphs for a complete description of the Write_block command:

- [Figure 12: Resettable OTP area \(addresses 0 to 4\).](#)
- [Figure 15: Binary counter \(addresses 5 to 6\).](#)
- [Figure 17: EEPROM \(addresses 7 to 15\).](#)

The Write_block command does not give rise to a response from the SRI512. The reader must check after the programming time, t_{W} , that the data was correctly programmed. The SRI512 must have received a Select() command and be switched to Selected state before any Write_block command can be accepted. All Write_block commands sent to the SRI512 before a Select() command is issued, are ignored.

Figure 44. Write_block request format

| SOF | Write_block | Address | Data 1 | Data 2 | Data 3 | Data 4 | CRC _L | CRC _H | EOF |
|-----|-------------|---------|--------|--------|--------|--------|------------------|------------------|-----|
| | 09h | 8 blts | 8 blts | 8 blts | 8 blts | 8 blts | 8 bits | 8 bits | |

AI07687b

Request parameters:

- Address: block addresses from 0 to 15, or 255
- Data 1: Less significant data byte
- Data 2: Data byte
- Data 3: Data byte
- Data 4: Most significant data byte.

Figure 45. Write_block response format

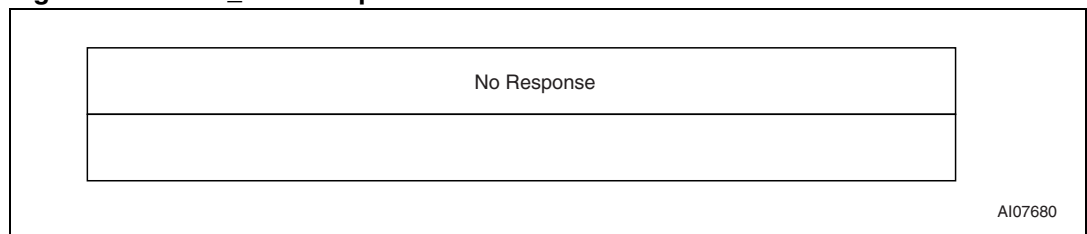
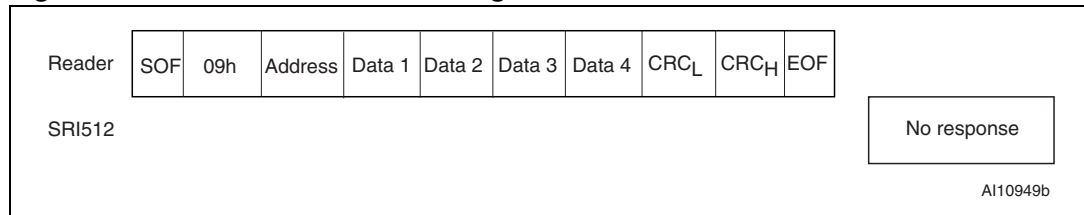

Figure 46. Write_block frame exchange between reader and SRI512



8.9 Get_UID() command

Command code = 0Bh

On receiving the Get_UID command, the SRI512 returns its 8 UID bytes. UID bytes are transmitted with the least significant byte first, and each byte is transmitted with the least significant bit first.

The SRI512 must have received a Select() command and be switched to Selected state before any Get_UID() command can be accepted. All Get_UID() commands sent to the SRI512 before a Select() command is issued, are ignored.

Figure 47. Get_UID request format

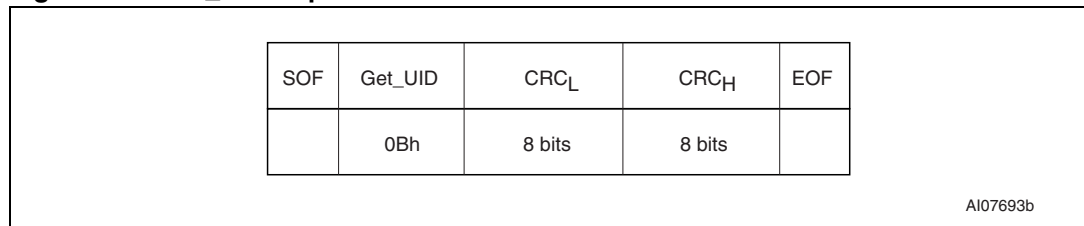

Request parameter:

- No parameter

Figure 48. Get_UID response format

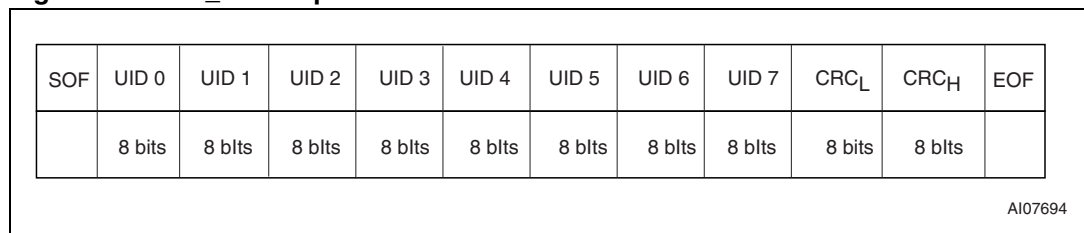

Response parameters:

- UID 0: Less significant UID byte
- UID 1 to UID 6: UID bytes
- UID 7: Most significant UID byte.

Unique Identifier (UID)

Members of the SRI512 family are uniquely identified by a 64-bit Unique Identifier (UID). This is used for addressing each SRI512 device uniquely after the anticollision loop. The UID complies with ISO/IEC 15963 and ISO/IEC 7816-6. It is a read-only code, and comprises (as summarized in *Figure 49*):

- an 8-bit prefix, with the most significant bits set to D0h
- an 8-bit IC manufacturer code (ISO/IEC 7816-6/AM1) set to 02h (for STMicroelectronics)
- a 6-bit IC code set to 00 0110b = 6d for SRI512
- a 42-bit unique serial number

Figure 49. 64-bit unique identifier of the SRI512

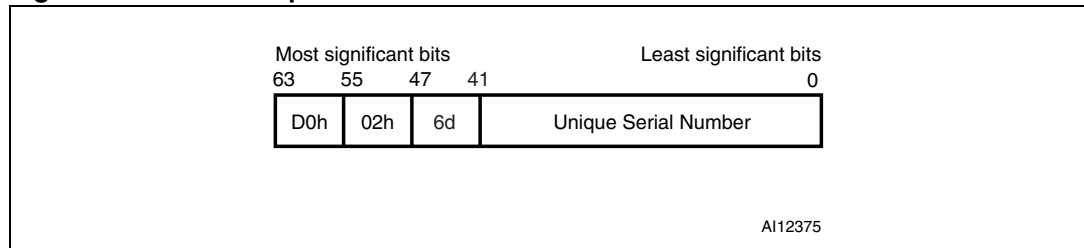
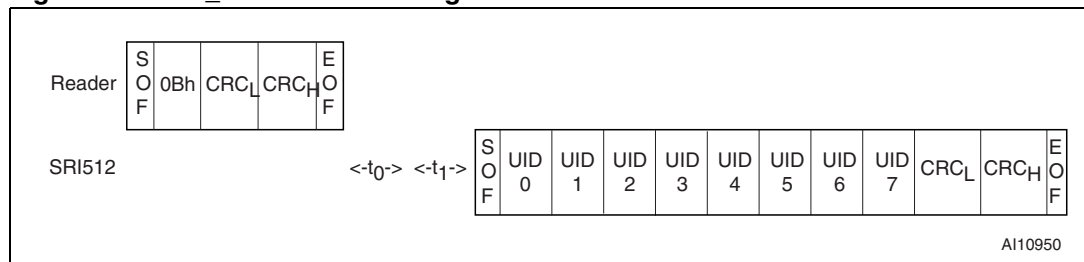

Figure 50. Get_UID frame exchange between reader and SRI512



8.10 Power-on state

After power-on, the SRI512 is in the following state:

- It is in the low-power state.
- It is in Ready state.
- It shows highest impedance with respect to the reader antenna field.
- It will not respond to any command except Initiate().

9 Maximum rating

Stressing the device above the rating listed in the absolute maximum ratings table may cause permanent damage to the device. These are stress ratings only and operation of the device at these or any other conditions above those indicated in the operating sections of this specification is not implied. Exposure to absolute maximum rating conditions for extended periods may affect device reliability. Refer also to the STMicroelectronics SURE Program and other relevant quality documents.

Table 6. Absolute maximum ratings

| Symbol | Parameter | | Min. | Max. | Unit |
|--------------------------------------|---------------------------------|---------------------------------|-------|------|--------|
| T _{STG} t _{STG} | Storage conditions | Wafer | 15 | 25 | °C |
| | | (kept in its antistatic bag) | | 23 | months |
| I _{CC} | Supply current on AC0 / AC1 | | -20 | 20 | mA |
| V _{MAX} | Input voltage on AC0 / AC1 | | -7 | 7 | V |
| V _{ESD} | Electrostatic discharge voltage | Machine model ⁽¹⁾ | -100 | 100 | V |
| | | Human body model ⁽¹⁾ | -1000 | 1000 | V |

1. Mil. Std. 883 - Method 3015

10 DC and AC parameters

Table 7. Operating conditions

| Symbol | Parameter | Min. | Max. | Unit |
|----------------|-------------------------------|------|------|------|
| T _A | Ambient operating temperature | -20 | 85 | °C |

Table 8. DC characteristics

| Symbol | Parameter | Condition | Min | Typ | Max | Unit |
|------------------|----------------------------------|-------------------------|-----|-----|-----|------|
| V _{CC} | Regulated voltage | | 2.5 | | 3.5 | V |
| I _{CC} | Supply current (active in read) | V _{CC} = 3.0 V | | | 100 | μA |
| I _{CC} | Supply current (active in write) | V _{CC} = 3.0 V | | | 250 | μA |
| V _{RET} | Backscattering-induced voltage | ISO 10373-6 | 20 | | | mV |
| C _{TUN} | Internal tuning capacitor | 13.56 MHz | | 64 | | pF |

Table 9. AC characteristics⁽¹⁾

| Symbol | Parameter | Condition | Min | Max | Unit |
|-------------------------------------|--|--------------------------------|--------|--------|------|
| f _{CC} | External RF signal frequency | | 13.553 | 13.567 | MHz |
| MI _{CARRIER} | Carrier modulation Index | MI=(A-B)/(A+B) | 8 | 14 | % |
| t _{RFR} , t _{RFF} | 10% rise and fall times | | 0.8 | 2.5 | μs |
| t _{RFSBL} | Minimum pulse width for start bit | ETU = 128/f _{CC} | 9.44 | | μs |
| t _{JIT} | ASK modulation data jitter | Coupler to SRI512 | -2 | +2 | μs |
| t _{MIN CD} | Minimum time from carrier generation to first data | | 5 | | ms |
| f _S | Subcarrier frequency | f _{CC} /16 | 847.5 | | kHz |
| t ₀ | Antenna reversal delay | 128/f _S | 151 | | μs |
| t ₁ | Synchronization delay | 128/f _S | 151 | | μs |
| t ₂ | Answer to new request delay | 14 ETU | 132 | | μs |
| t _{DR} | Time between request characters | Coupler to SRI512 | 0 | 57 | μs |
| t _{DA} | Time between answer characters | SRI512 to coupler | 0 | | μs |
| t _W | Programming time for write | With no auto-erase cycle (OTP) | | 3 | ms |
| | | With auto-erase cycle (EEPROM) | | 5 | ms |
| | | Binary counter decrement | | 7 | ms |

1. All timing measurements were performed on a reference antenna with the following characteristics:
 External size: 75 mm x 48 mm
 Number of turns: 3
 Width of conductor: 1 mm
 Space between 2 conductors: 0.4 mm
 Value of the coil: 1.4 μH
 Tuning Frequency: 14.4 MHz.

Figure 51. SRI512 synchronous timing, transmit and receive

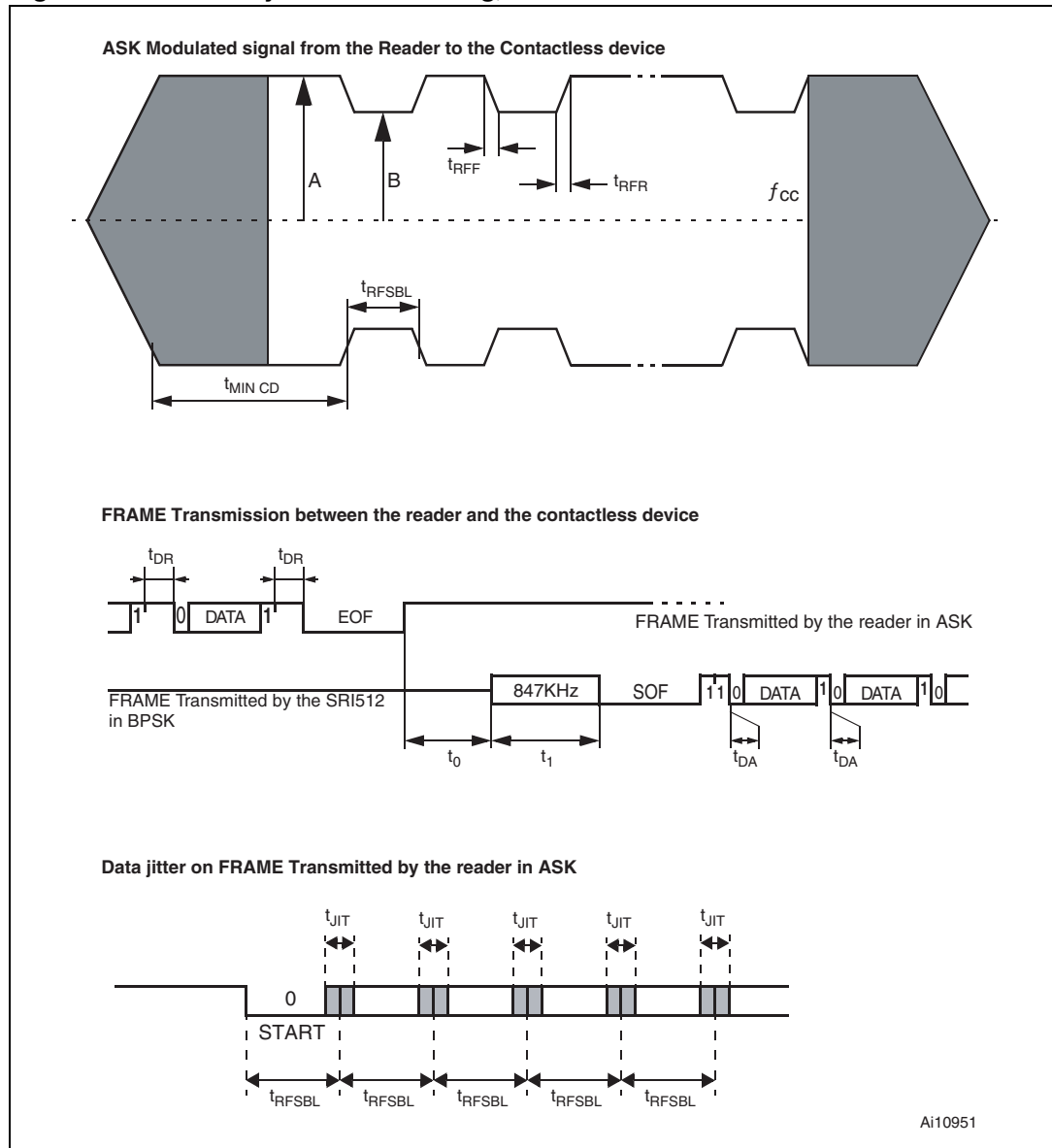

11 Part numbering

Table 10. Ordering information scheme

| | | | |
|----------------------|--|---|----------|
| Example: | SRI512 | - | W4 / 1GE |
| Device type | SRI512 | | |
| Package | W4 = 180 μm ± 15 μm unsawn wafer SBN18 = 180 μm ± 15 μm bumped and sawn wafer on 8-inch frame | | |
| Customer code | 1GE = generic product xxx = customer code after personalization | | |

Note: Devices are shipped from the factory with the memory content bits erased to 1.
For a list of available options (speed, package, etc.) or for further information on any aspect of this device, please contact your nearest ST sales office.

Appendix A ISO 14443 Type B CRC calculation

```

#include <stdio.h>
#include <stdlib.h>
#include <string.h>
#include <ctype.h>
#define BYTE unsigned char
#define USHORT unsigned short

unsigned short UpdateCrc(BYTE ch, USHORT *lpwCrc)
{
    ch = (ch^(BYTE)((*lpwCrc) & 0x00FF));
    ch = (ch^(ch<<4));
    *lpwCrc = (*lpwCrc >> 8)^((USHORT)ch <<
8)^((USHORT)ch<<3)^((USHORT)ch>>4);
    return(*lpwCrc);
}

void ComputeCrc(char *Data, int Length, BYTE *TransmitFirst, BYTE
*TransmitSecond)
{
    BYTE chBlock; USHORTt wCrc;
    wCrc = 0xFFFF; // ISO 3309
    do
    {
        {
            chBlock = *Data++;
            UpdateCrc(chBlock, &wCrc);
        } while (--Length);
    }
    wCrc = ~wCrc; // ISO 3309
    *TransmitFirst = (BYTE) (wCrc & 0xFF);
    *TransmitSecond = (BYTE) ((wCrc >> 8) & 0xFF);
    return;
}

int main(void)
{
    BYTE BuffCRC_B[10] = {0x0A, 0x12, 0x34, 0x56}, First, Second, i;
    printf("Crc-16 G(x) = x^16 + x^12 + x^5 + 1");
    printf("CRC_B of [ ");
    for(i=0; i<4; i++)
        printf("%02X ",BuffCRC_B[i]);
    ComputeCrc(BuffCRC_B, 4, &First, &Second);
    printf("] Transmitted: %02X then %02X.", First, Second);
    return(0);
}

```

Appendix B SRI512 command brief

Figure 52. Initiate frame exchange between reader and SRI512

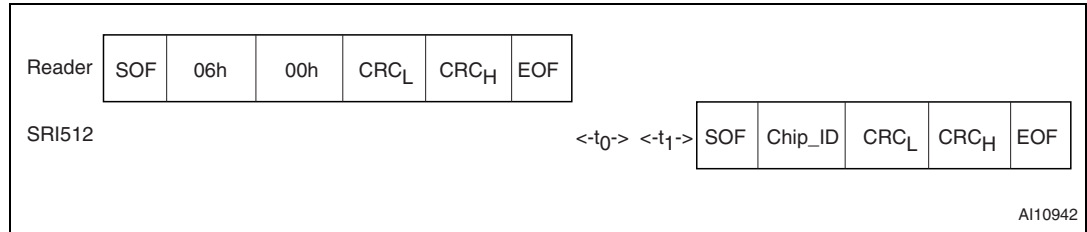

Figure 53. Pcall16 frame exchange between reader and SRI512

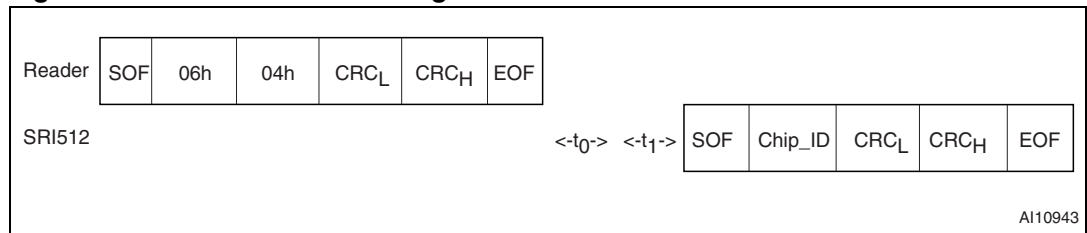

Figure 54. Slot_marker frame exchange between reader and SRI512

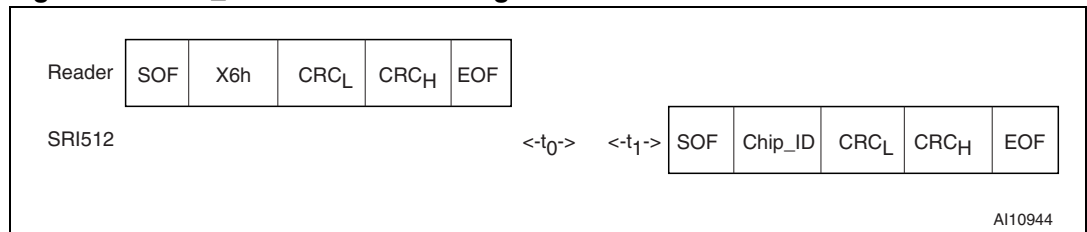

Figure 55. Select frame exchange between reader and SRI512

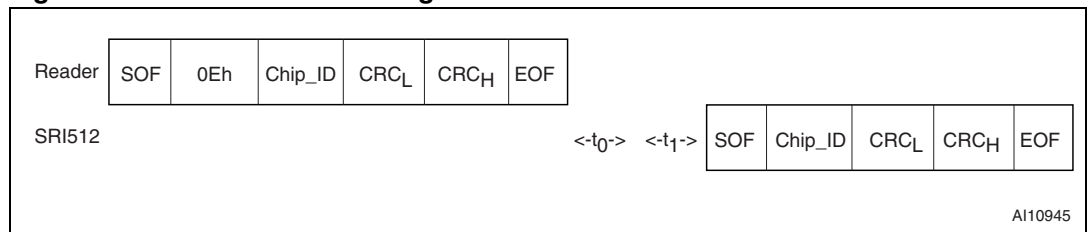

Figure 56. Completion frame exchange between reader and SRI512

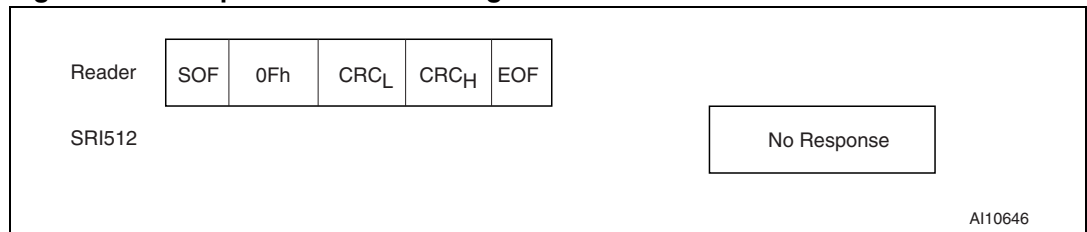

Figure 57. Reset_to_inventory frame exchange between reader and SRI512

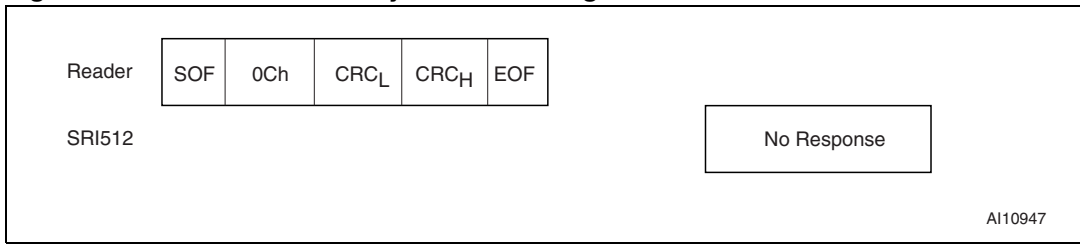

Figure 58. Read_block frame exchange between reader and SRI512

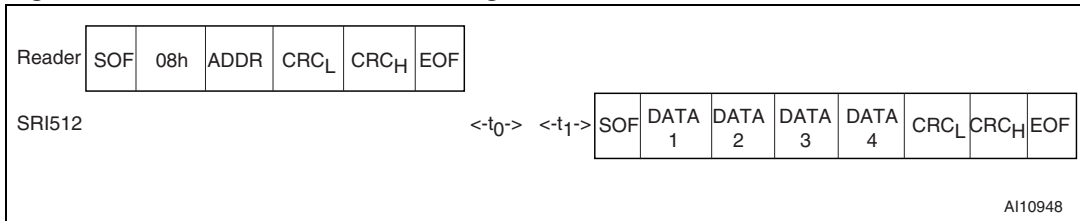

Figure 59. Write_block frame exchange between reader and SRI512

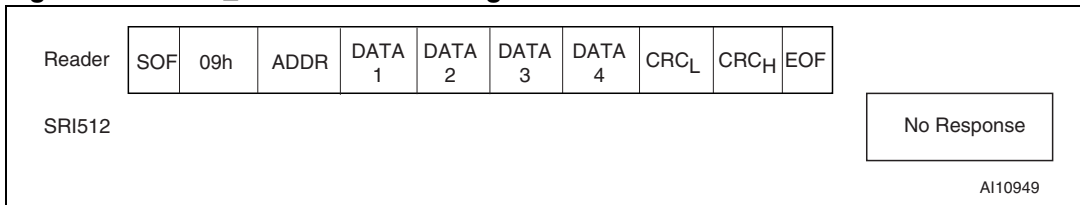
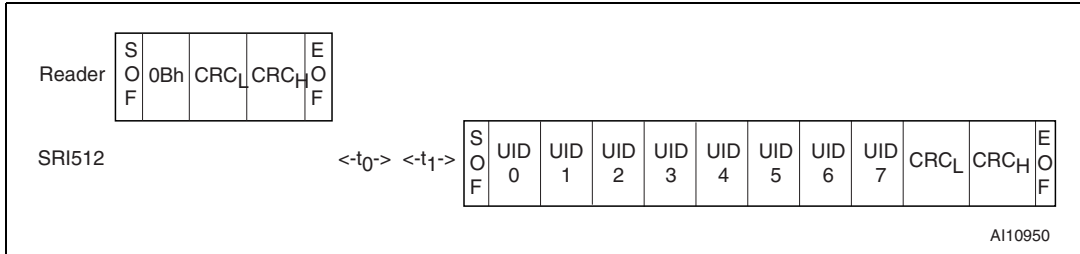

Figure 60. Get_UID frame exchange between reader and SRI512



Revision history

Table 11. Document revision history

| Date | Revision | Changes |
|-------------|----------|--|
| 10-Apr-2006 | 1 | Initial release. |
| 31-Oct-2006 | 2 | Document status promoted from Target Specification to Preliminary Data. The Resettable OTP area can no longer be optionally set as a lockable EEPROM area. References to the OTP_Config_bit removed, this bit is always at '0'. V_{RET} and C_{TUN} added to Table 8: DC characteristics . |
| 05-Apr-2007 | 3 | Document status promoted from Preliminary Data to full Datasheet. C_{TUN} min and max values removed, typical value added in Table 8: DC characteristics . Small text changes. All antennas are ECOPACK® compliant. |
| 28-Aug-2008 | 4 | SRI512 products are no longer delivered with A3, A4 and A5 antennas. Table 6: Absolute maximum ratings and Table 10: Ordering information scheme clarified. Small text changes. |

Please Read Carefully:

Information in this document is provided solely in connection with ST products. STMicroelectronics NV and its subsidiaries ("ST") reserve the right to make changes, corrections, modifications or improvements, to this document, and the products and services described herein at any time, without notice.

All ST products are sold pursuant to ST's terms and conditions of sale.

Purchasers are solely responsible for the choice, selection and use of the ST products and services described herein, and ST assumes no liability whatsoever relating to the choice, selection or use of the ST products and services described herein.

No license, express or implied, by estoppel or otherwise, to any intellectual property rights is granted under this document. If any part of this document refers to any third party products or services it shall not be deemed a license grant by ST for the use of such third party products or services, or any intellectual property contained therein or considered as a warranty covering the use in any manner whatsoever of such third party products or services or any intellectual property contained therein.

UNLESS OTHERWISE SET FORTH IN ST'S TERMS AND CONDITIONS OF SALE ST DISCLAIMS ANY EXPRESS OR IMPLIED WARRANTY WITH RESPECT TO THE USE AND/OR SALE OF ST PRODUCTS INCLUDING WITHOUT LIMITATION IMPLIED WARRANTIES OF MERCHANTABILITY, FITNESS FOR A PARTICULAR PURPOSE (AND THEIR EQUIVALENTS UNDER THE LAWS OF ANY JURISDICTION), OR INFRINGEMENT OF ANY PATENT, COPYRIGHT OR OTHER INTELLECTUAL PROPERTY RIGHT.

UNLESS EXPRESSLY APPROVED IN WRITING BY AN AUTHORIZED ST REPRESENTATIVE, ST PRODUCTS ARE NOT RECOMMENDED, AUTHORIZED OR WARRANTED FOR USE IN MILITARY, AIR CRAFT, SPACE, LIFE SAVING, OR LIFE SUSTAINING APPLICATIONS, NOR IN PRODUCTS OR SYSTEMS WHERE FAILURE OR MALFUNCTION MAY RESULT IN PERSONAL INJURY, DEATH, OR SEVERE PROPERTY OR ENVIRONMENTAL DAMAGE. ST PRODUCTS WHICH ARE NOT SPECIFIED AS "AUTOMOTIVE GRADE" MAY ONLY BE USED IN AUTOMOTIVE APPLICATIONS AT USER'S OWN RISK.

Resale of ST products with provisions different from the statements and/or technical features set forth in this document shall immediately void any warranty granted by ST for the ST product or service described herein and shall not create or extend in any manner whatsoever, any liability of ST.

ST and the ST logo are trademarks or registered trademarks of ST in various countries.

Information in this document supersedes and replaces all information previously supplied.

The ST logo is a registered trademark of STMicroelectronics. All other names are the property of their respective owners.

© 2008 STMicroelectronics - All rights reserved

STMicroelectronics group of companies

Australia - Belgium - Brazil - Canada - China - Czech Republic - Finland - France - Germany - Hong Kong - India - Israel - Italy - Japan - Malaysia - Malta - Morocco - Singapore - Spain - Sweden - Switzerland - United Kingdom - United States of America

www.st.com

