

FDA24N40F

N-Channel MOSFET, FRFET

400V, 23A, 0.19Ω

Features

- $R_{DS(on)} = 0.15\Omega$ (Typ.) @ $V_{GS} = 10V, I_D = 11.5A$
- Low gate charge (Typ. 46nC)
- Low Crss (Typ. 25pF)
- Fast switching
- 100% avalanche tested
- Improved dv/dt capability
- RoHS compliant



Description

These N-Channel enhancement mode power field effect transistors are produced using Fairchild's proprietary, planar stripe, DMOS technology.

This advanced technology has been especially tailored to minimize on-state resistance, provide superior switching performance, and withstand high energy pulse in the avalanche and commutation mode. These devices are well suited for high efficient switched mode power supplies and active power factor correction.

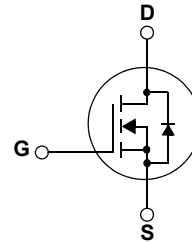
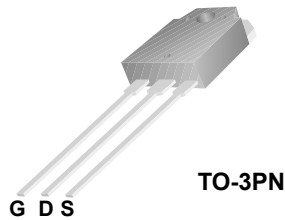

MOSFET Maximum Ratings $T_C = 25^\circ\text{C}$ unless otherwise noted*

Symbol	Parameter	Ratings	Units
V_{DSS}	Drain to Source Voltage	400	V
V_{GSS}	Gate to Source Voltage	± 30	V
I_D	Drain Current	-Continuous ($T_C = 25^\circ\text{C}$)	23
		-Continuous ($T_C = 100^\circ\text{C}$)	13.8
I_{DM}	Drain Current	- Pulsed (Note 1)	92
E_{AS}	Single Pulsed Avalanche Energy	(Note 2)	1190
I_{AR}	Avalanche Current	(Note 1)	23
E_{AR}	Repetitive Avalanche Energy	(Note 1)	23.5
dv/dt	Peak Diode Recovery dv/dt	(Note 3)	4.5
P_D	Power Dissipation	($T_C = 25^\circ\text{C}$)	235
		- Derate above 25°C	1.8
T_J, T_{STG}	Operating and Storage Temperature Range	-55 to +150	$^\circ\text{C}$
T_L	Maximum Lead Temperature for Soldering Purpose, 1/8" from Case for 5 Seconds	300	$^\circ\text{C}$

Thermal Characteristics

Symbol	Parameter	Min.	Max.	Units
$R_{\theta JC}$	Thermal Resistance, Junction to Case	-	0.53	$^\circ\text{C/W}$
$R_{\theta CS}$	Thermal Resistance, Case to Sink Typ.	0.24	-	
$R_{\theta JA}$	Thermal Resistance, Junction to Ambient	-	40	

Package Marking and Ordering Information $T_C = 25^\circ\text{C}$ unless otherwise noted

Device Marking	Device	Package	Reel Size	Tape Width	Quantity
FDA24N40F	FDA24N40F	TO-3PN	-	-	30

Electrical Characteristics

Symbol	Parameter	Test Conditions	Min.	Typ.	Max.	Units
--------	-----------	-----------------	------	------	------	-------

Off Characteristics

BV_{DSS}	Drain to Source Breakdown Voltage	$I_D = 250\mu\text{A}, V_{GS} = 0\text{V}, T_J = 25^\circ\text{C}$	400	-	-	V
$\frac{\Delta BV_{DSS}}{\Delta T_J}$	Breakdown Voltage Temperature Coefficient	$I_D = 250\mu\text{A}$, Referenced to 25°C	-	0.5	-	$\text{V}/^\circ\text{C}$
I_{DSS}	Zero Gate Voltage Drain Current	$V_{DS} = 400\text{V}, V_{GS} = 0\text{V}$ $V_{DS} = 320\text{V}, T_C = 125^\circ\text{C}$	-	-	10 100	μA
I_{GSS}	Gate to Body Leakage Current	$V_{GS} = \pm 30\text{V}, V_{DS} = 0\text{V}$	-	-	± 100	nA

On Characteristics

$V_{GS(th)}$	Gate Threshold Voltage	$V_{GS} = V_{DS}, I_D = 250\mu\text{A}$	3.0	-	5.0	V
$R_{DS(on)}$	Static Drain to Source On Resistance	$V_{GS} = 10\text{V}, I_D = 11.5\text{A}$	-	0.15	0.19	Ω
g_{FS}	Forward Transconductance	$V_{DS} = 20\text{V}, I_D = 11.5\text{A}$ (Note 4)	-	29	-	S

Dynamic Characteristics

C_{iss}	Input Capacitance	$V_{DS} = 25\text{V}, V_{GS} = 0\text{V}$ $f = 1\text{MHz}$	-	2280	3030	pF
C_{oss}	Output Capacitance		-	370	490	pF
C_{rss}	Reverse Transfer Capacitance		-	25	38	pF
$Q_{g(tot)}$	Total Gate Charge at 10V	$V_{DS} = 320\text{V}$ $I_D = 23\text{A}$ (Note 4, 5)	-	46	60	nC
Q_{gs}	Gate to Source Gate Charge		-	13	-	nC
Q_{gd}	Gate to Drain "Miller" Charge		-	18	-	nC

Switching Characteristics

$t_{d(on)}$	Turn-On Delay Time	$V_{DS} = 200\text{V}, I_D = 23\text{A}$ $R_G = 25\Omega$ (Note 4, 5)	-	40	90	ns
t_r	Turn-On Rise Time		-	92	195	ns
$t_{d(off)}$	Turn-Off Delay Time		-	120	250	ns
t_f	Turn-Off Fall Time		-	75	160	ns

Drain-Source Diode Characteristics

I_S	Maximum Continuous Drain to Source Diode Forward Current	-	-	23	A	
I_{SM}	Maximum Pulsed Drain to Source Diode Forward Current	-	-	92	A	
V_{SD}	Drain to Source Diode Forward Voltage	$V_{GS} = 0\text{V}, I_{SD} = 23\text{A}$	-	-	1.5	V
t_{rr}	Reverse Recovery Time	$V_{GS} = 0\text{V}, I_{SD} = 23\text{A}$	-	110	-	ns
Q_{rr}	Reverse Recovery Charge	$di_F/dt = 100\text{A}/\mu\text{s}$ (Note 4)	-	0.3	-	μC

Notes:

- 1: Repetitive Rating: Pulse width limited by maximum junction temperature
- 2: $L = 4.5\text{mH}, I_{AS} = 23\text{A}, V_{DD} = 50\text{V}, R_G = 25\Omega$, Starting $T_J = 25^\circ\text{C}$
- 3: $I_{SD} \leq 23\text{A}, di/dt \leq 200\text{A}/\mu\text{s}, V_{DD} \leq BV_{DSS}$, Starting $T_J = 25^\circ\text{C}$
- 4: Pulse Test: Pulse width $\leq 300\mu\text{s}$, Duty Cycle $\leq 2\%$
- 5: Essentially Independent of Operating Temperature Typical Characteristics

Typical Performance Characteristics

Figure 1. On-Region Characteristics

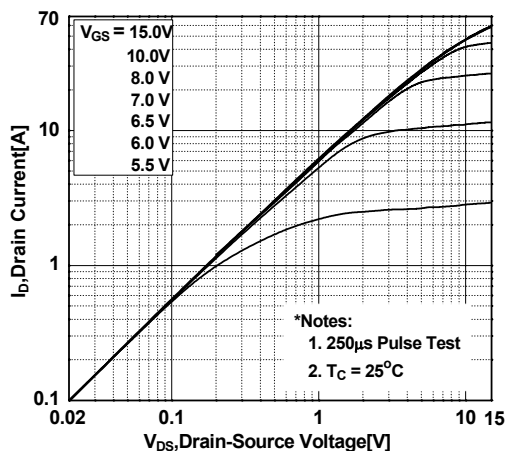

Figure 2. Transfer Characteristics

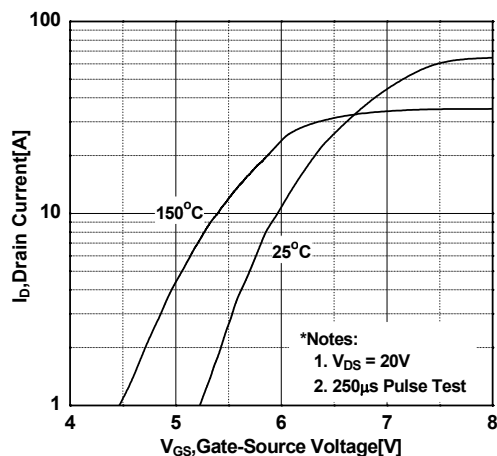

Figure 3. On-Resistance Variation vs. Drain Current and Gate Voltage

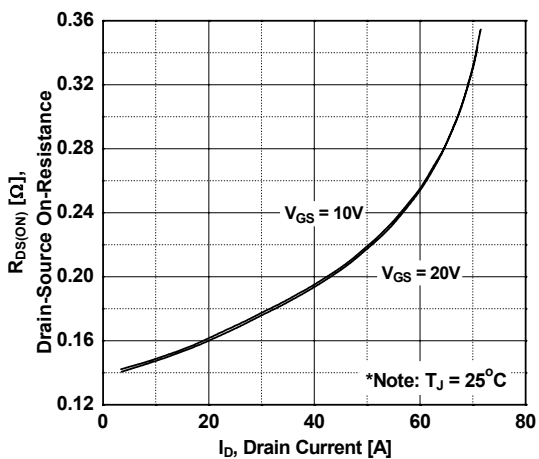

Figure 4. Body Diode Forward Voltage Variation vs. Source Current and Temperature

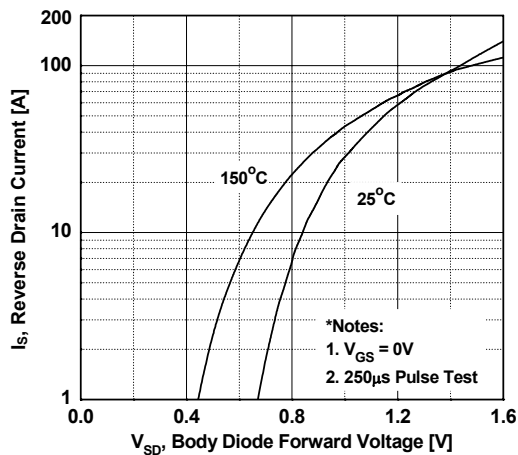

Figure 5. Capacitance Characteristics

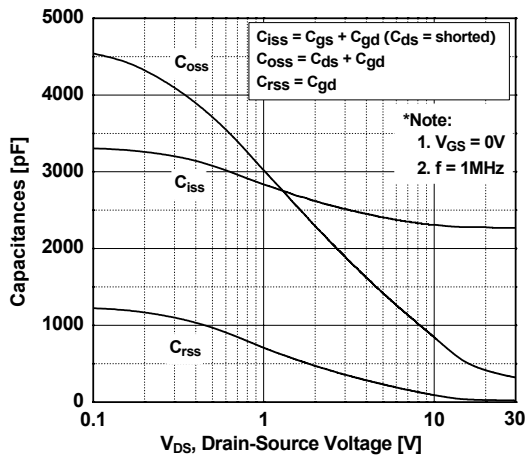
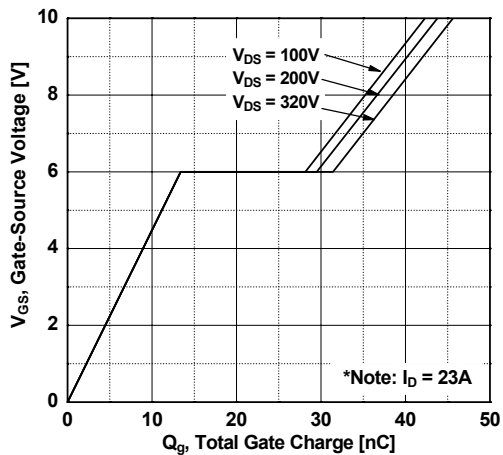

Figure 6. Gate Charge Characteristics



Typical Performance Characteristics (Continued)

Figure 7. Breakdown Voltage Variation vs. Temperature

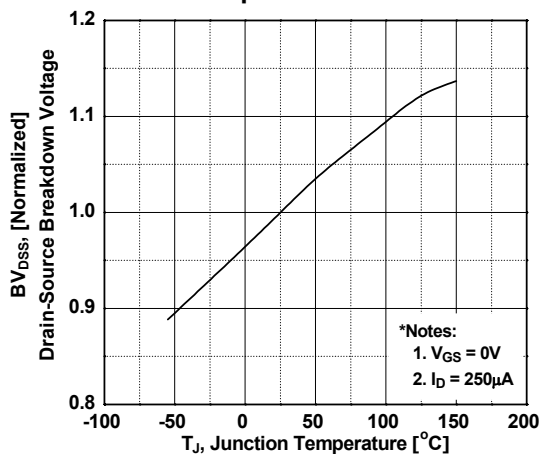

Figure 8. Maximum Safe Operating Area

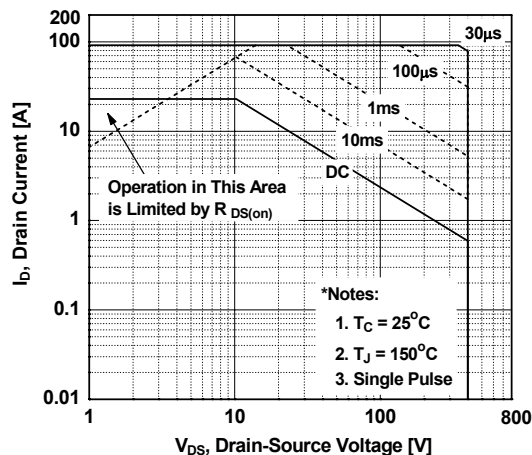

Figure 9. Maximum Drain Current vs. Case Temperature

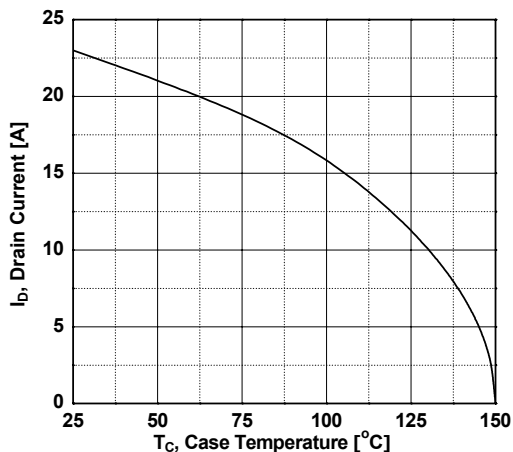
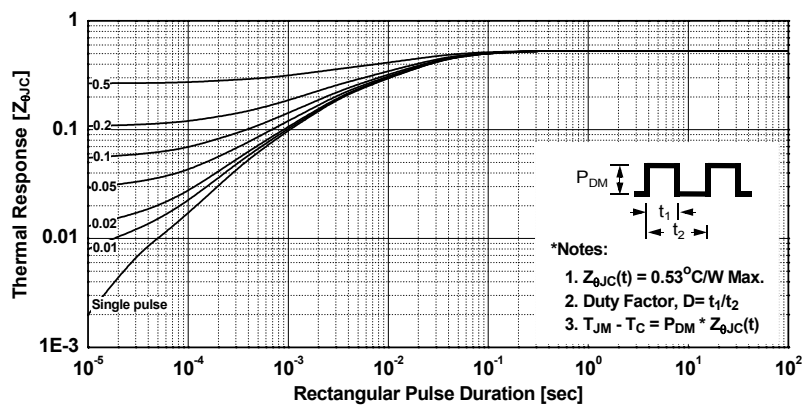
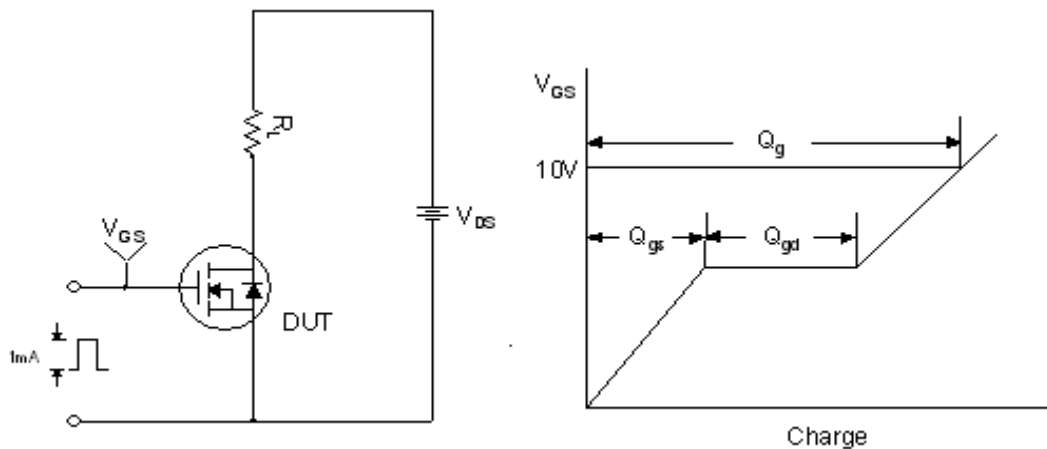

Figure 10. Transient Thermal Response Curve



Gate Charge Test Circuit & Waveform



Resistive Switching Test Circuit & Waveforms



Unclamped Inductive Switching Test Circuit & Waveforms

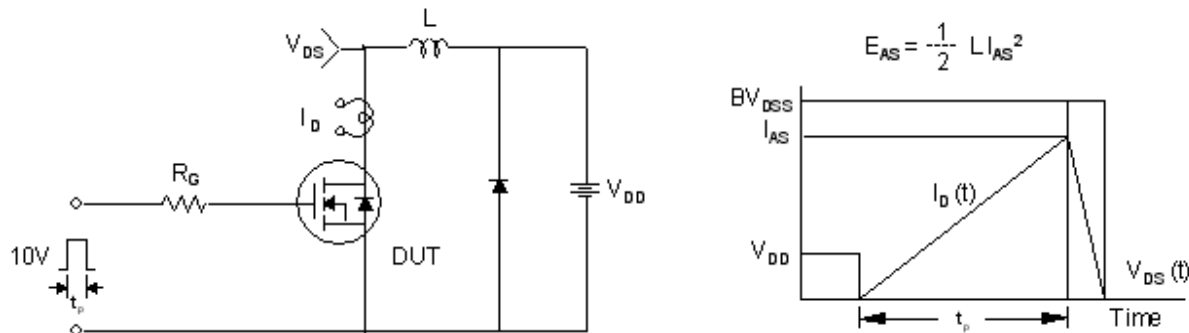

Peak Diode Recovery dv/dt Test Circuit & Waveforms

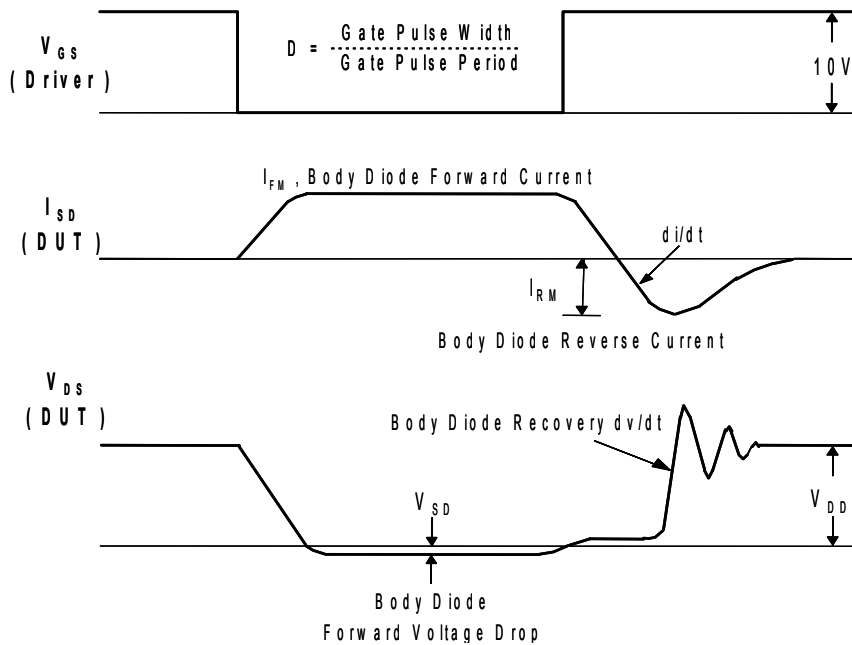
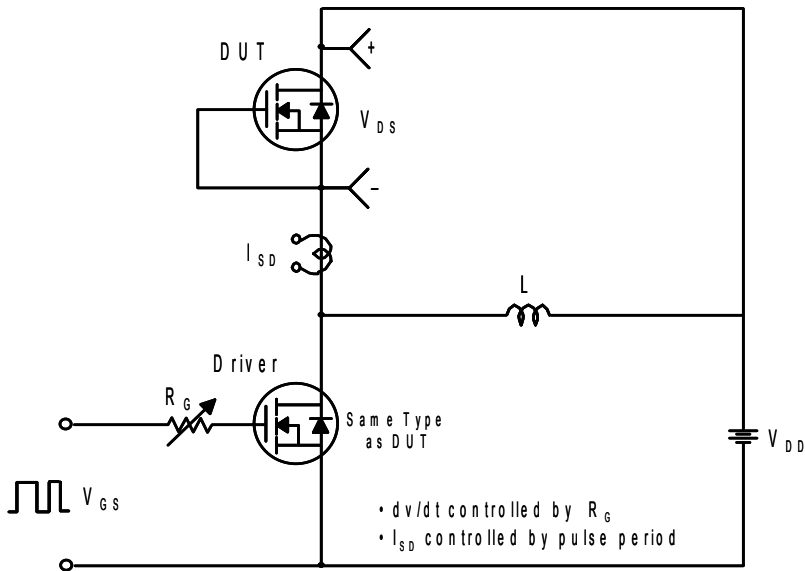

Mechanical Dimensions

TO-3PN

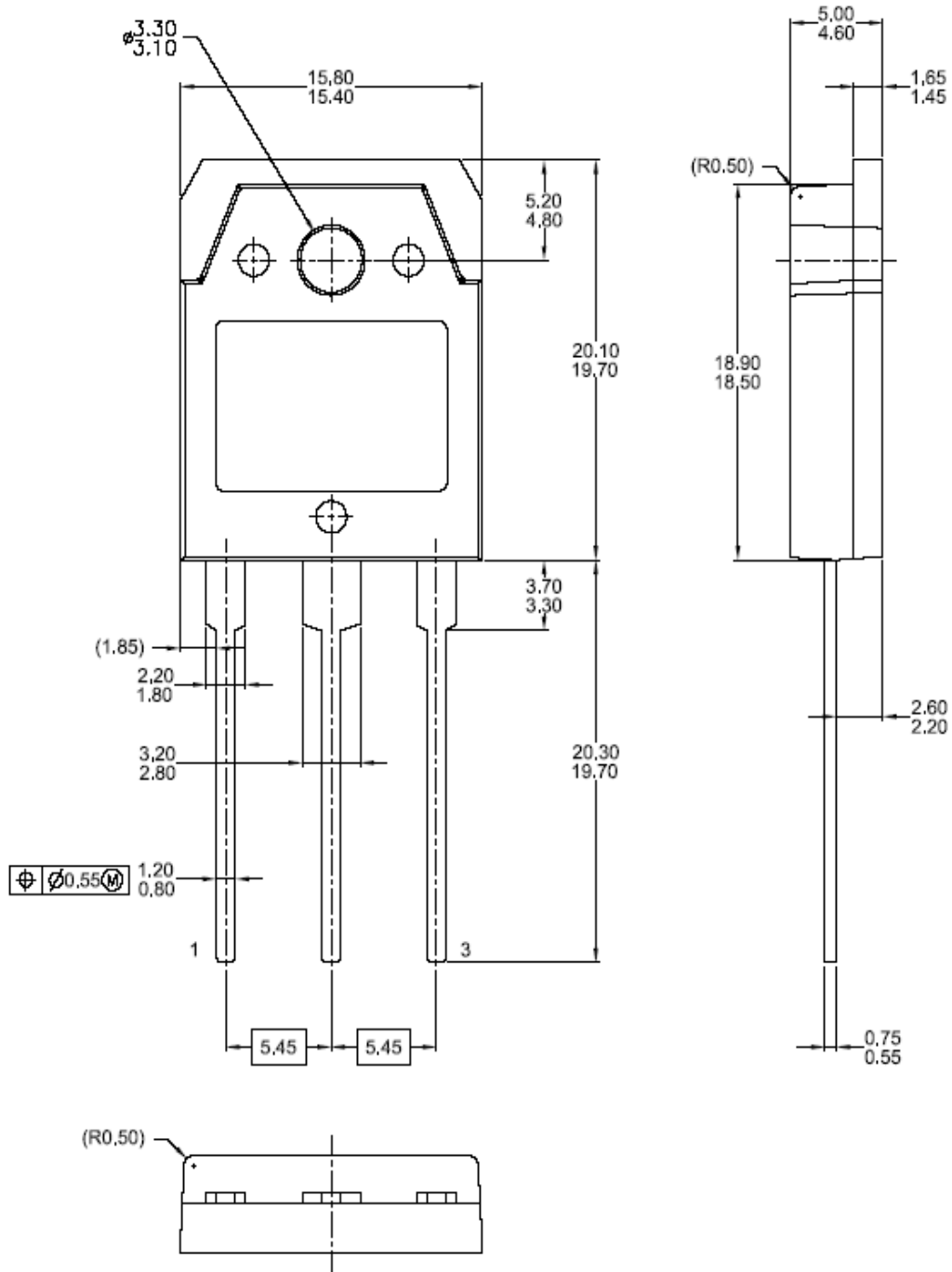





Dimensions in Millimeters

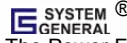

TRADEMARKS

The following are registered and unregistered trademarks and service marks Fairchild Semiconductor owns or is authorized to use and is not intended to be an exhaustive list of all such trademarks.

ACEx [®]	FPS [™]	PDP-SPM [™]	SyncFET [™]
Build it Now [™]	FRFET [®]	Power220 [®]	 SYSTEM GENERAL [®]
CorePLUS [™]	Global Power Resource SM	Power247 [®]	The Power Franchise [®]
CROSSVOLT [™]	Green FPS [™]	POWEREDGE [®]	the power franchise
CTL [™]	Green FPS [™] e-Series [™]	Power-SPM [™]	TinyBoost [™]
Current Transfer Logic [™]	GTO [™]	PowerTrench [®]	TinyBuck [™]
EcoSPARK [®]	<i>i-Lo</i> [™]	Programmable Active Droop [™]	TinyLogic [®]
EZSWITCH [™] *	IntelliMAX [™]	QFET [®]	TINYOPTO [™]
 EZ [™]	ISOPLANAR [™]	QS [™]	TinyPower [™]
 F [®]	MegaBuck [™]	QT Optoelectronics [™]	TinyPWM [™]
Fairchild [®]	MICROCOUPLER [™]	Quiet Series [™]	TinyWire [™]
Fairchild Semiconductor [®]	MicroFET [™]	RapidConfigure [™]	μSerDes [™]
FACT Quiet Series [™]	MicroPak [™]	SMART START [™]	UHC [®]
FACT [®]	MillerDrive [™]	SPM [®]	Ultra FRFET [™]
FAST [®]	Motion-SPM [™]	STEALTH [™]	UniFET [™]
FastvCore [™]	OPTOLOGIC [®]	SuperFET [™]	VCX [™]
FlashWriter [®] *	OPTOPLANAR [®]	SuperSOT [™] -3	
		SuperSOT [™] -6	
		SuperSOT [™] -8	

* EZSWITCH[™] and FlashWriter[®] are trademarks of System General Corporation, used under license by Fairchild Semiconductor.

DISCLAIMER

FAIRCHILD SEMICONDUCTOR RESERVES THE RIGHT TO MAKE CHANGES WITHOUT NOTICE TO ANY PRODUCTS HEREIN TO IMPROVE RELIABILITY, FUNCTION, OR DESIGN. FAIRCHILD DOES NOT ASSUME ANY LIABILITY ARISING OUT OF THE APPLICATION OR USE OF ANY PRODUCT OR CIRCUIT DESCRIBED HEREIN; NEITHER DOES IT CONVEY ANY LICENSE UNDER ITS PATENT RIGHTS, NOR THE RIGHTS OF OTHERS. THESE SPECIFICATIONS DO NOT EXPAND THE TERMS OF FAIRCHILD'S WORLDWIDE TERMS AND CONDITIONS, SPECIFICALLY THE WARRANTY THEREIN, WHICH COVERS THESE PRODUCTS.

LIFE SUPPORT POLICY

FAIRCHILD'S PRODUCTS ARE NOT AUTHORIZED FOR USE AS CRITICAL COMPONENTS IN LIFE SUPPORT DEVICES OR SYSTEMS WITHOUT THE EXPRESS WRITTEN APPROVAL OF FAIRCHILD SEMICONDUCTOR CORPORATION.

As used herein:

1. Life support devices or systems are devices or systems which, (a) are intended for surgical implant into the body, or (b) support or sustain life, and (c) whose failure to perform when properly used in accordance with instructions for use provided in the labeling, can be reasonably expected to result in significant injury to the user.
2. A critical component is any component of a life support device or system whose failure to perform can be reasonably expected to cause the failure of the life support device or system, or to affect its safety or effectiveness.

PRODUCT STATUS DEFINITIONS

Definition of Terms

Datasheet Identification	Product Status	Definition
Advance Information	Formative or In Design	This datasheet contains the design specifications for product development. Specifications may change in any manner without notice.
Preliminary	First Production	This datasheet contains preliminary data; supplementary data will be published at a later date. Fairchild Semiconductor reserves the right to make changes at any time without notice to improve design.
No Identification Needed	Full Production	This datasheet contains final specifications. Fairchild Semiconductor reserves the right to make changes at any time without notice to improve design.
Obsolete	Not In Production	This datasheet contains specifications on a product that has been discontinued by Fairchild semiconductor. The datasheet is printed for reference information only.

Rev. I32