

Synchronous 4 Bit Counters; Binary, Direct Reset

KK74LS161

This synchronous, presettable counter features an internal carry look-ahead for application in high-speed counting designs. Synchronous operation is provided by having all flip-flops clocked simultaneously so that the outputs change coincident with each other when so instructed by the count-enable inputs and internal gating.

This mode of operation eliminates the output counting spikes that are normally associated with asynchronous (ripple clock) counters. A buffered clock input triggers the four flip-flops on the rising (positive-going) edge of the clock input wave form.

This counter is fully programmable; that is the outputs may be preset to either level. As presetting is synchronous setting up a low level at the load input disables the counter and causes the outputs to agree with the setup data after the next clock pulse regardless of the levels of the enable inputs.

The carry look-ahead circuitry provides for cascading counters for n-bit synchronous applications without additional gating. Instrumental in accomplishing this function are two counter-enable inputs and a ripple carry output. Both countenable inputs (ENABLE P and ENABLE T) must be high to count, and ENABLE T is fed forward to enable the ripple carry output. The ripple carry output thus enabled will produce a high-level output pulse with a duration approximately equal to the high level portion of the Q_A output. The high-level overflow ripple carry pulse can be enable successive cascaded stages. Transitions at the ENP or ENT are allowed regardless of the level of the clock input.

- Internal Look-Ahead for Fast Counting
- Carry Output for n-Bit Cascading
- Synchronous Counting
- Synchronously Programmable
- Load Control Line
- Diode-Clamped Inputs

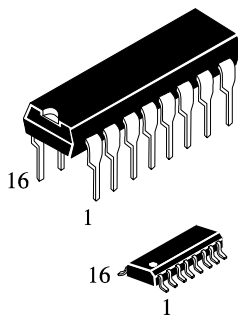

N SUFFIX PLASTIC

D SUFFIX SOIC

ORDERING INFORMATION
 KK74LS161N Plastic
 KK74LS161D SOIC
 $T_A = 0^\circ \text{ to } 70^\circ \text{ C}$ for all packages

PIN ASSIGNMENT



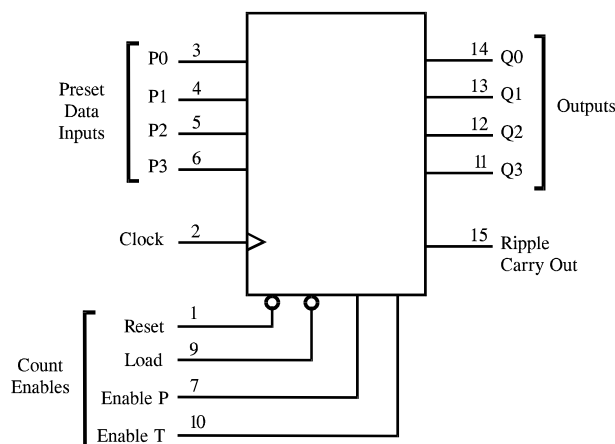

Reset	1 ●	16	V_{CC}
Clock	2	15	Ripple Carry Out
P0	3	14	Q0
P1	4	13	Q1
P2	5	12	Q2
P3	6	11	Q3
Enable P	7	10	Enable T
GND	8	9	Load

LOGIC DIAGRAM



PIN 16 = V_{CC}
 PIN 8 = GND

FUNCTION TABLE

Inputs					Outputs				Function
Reset	Load	Enable P	Enable T	Clock	Q0	Q1	Q2	Q3	
L	X	X	X	X	L	L	L	L	Reset to "0"
H	L	X	X		P0	P1	P2	P3	Preset Data
H	H	X	L		No change				No count
H	H	L	X		No change				No count
H	H	H	H		Count up				Count
H	X	X	X		No change				No count

X=don't care

P0,P1,P2,P3 = logic level of Data inputs

Ripple Carry Out = Enable T • Q0 • Q1 • Q2 • Q3

MAXIMUM RATINGS*

Symbol	Parameter	Value	Unit
V _{CC}	Supply Voltage	7.0	V
V _{IN}	Input Voltage	7.0	V
V _{OUT}	Output Voltage	5.5	V
Tstg	Storage Temperature Range	-65 to +150	°C

*Maximum Ratings are those values beyond which damage to the device may occur. Functional operation should be restricted to the Recommended Operating Conditions.

RECOMMENDED OPERATING CONDITIONS

Symbol	Parameter	Min	Max	Unit
V _{CC}	Supply Voltage	4.75	5.25	V
V _{IH}	High Level Input Voltage	2.0		V
V _{IL}	Low Level Input Voltage		0.8	V
I _{OH}	High Level Output Current		-0.4	mA
I _{OL}	Low Level Output Current		8.0	mA
f _{clock}	Clock frequency	0	25	MHz
t _{w(clock)}	Width of clock pulse	25		ns
t _{w(reset)}	Width of reset pulse	20		ns
t _{su}	Setup time	Data inputs P0, P1, P2, P3	20	ns
		Enable P or T	20	
		Load	20	
t _h	Hold time at any input	3		ns
T _A	Ambient Temperature Range	0	+70	°C

DC ELECTRICAL CHARACTERISTICS over full operating conditions

Symbol	Parameter		Test Conditions	Guaranteed Limit		Unit	
				Min	Max		
V_{IK}	Input Clamp Voltage		$V_{CC} = \text{min}, I_{IN} = -18 \text{ mA}$		-1.5	V	
V_{OH}	High Level Output Voltage		$V_{CC} = \text{min}, I_{OH} = -0.4 \text{ mA}$	2.7		V	
V_{OL}	Low Level Output Voltage		$V_{CC} = \text{min}, I_{OL} = 4 \text{ mA}$		0.4	V	
			$V_{CC} = \text{min}, I_{OL} = 8 \text{ mA}$		0.5		
I_{IH}	High Level Input Current		$V_{CC} = \text{max}$ $V_{IN} = 2.7 \text{ V}$	Data or enable P		20	μA
				Load, clock or enable T		40	
				Reset		20	
			$V_{CC} = \text{max}$ $V_{IN} = 7.0 \text{ V}$	Data or enable P		0.1	mA
				Load, clock or enable T		0.2	
				Reset		0.1	
I_{IL}	Low Level Input Current		$V_{CC} = \text{max}$ $V_{IN} = 0.4 \text{ V}$	Data or enable P		-0.4	mA
				Load, clock or enable T		-0.8	
				Reset			
I_O	Output Short Circuit Current		$V_{CC} = \text{max}, V_O = 0 \text{ V}$ (Note 1)	-20	-100	mA	
I_{CC}	Supply Current	All outputs high	$V_{CC} = \text{max}$ (Note 2)		31	mA	
		All outputs low	$V_{CC} = \text{max}$ (Note 3)		32		

Note 1: Not more than one output should be shorted at a time, and the duration should not exceed one second.

Note 2: I_{CCH} is measured with the load high, then again with the load low, with all other inputs high and all outputs open.

Note 3: I_{CCL} is measured with the clock input high, then again with the clock input low, with all other inputs low and all outputs open.

AC ELECTRICAL CHARACTERISTICS ($T_A=25^\circ\text{C}$, $V_{CC} = 5.0\text{ V}$, $C_L = 15\text{ pF}$, $R_L = 2\text{ k}\Omega$, $t_r=15\text{ ns}$, $t_f = 6.0\text{ ns}$)

Symbol	Parameter	Min	Max	Unit
t_{PLH}	Propagation Delay, Clock to Ripple carry		35	ns
t_{PHL}	Propagation Delay, Clock to Ripple carry		35	ns
t_{PLH}	Propagation Delay, Clock (load input high) to Any Q		24	ns
t_{PHL}	Propagation Delay, Clock (load input high) to Any Q		27	ns
t_{PLH}	Propagation Delay, Clock (load input low) to Any Q		24	ns
t_{PHL}	Propagation Delay, Clock (load input low) to Any Q		27	ns
t_{PLH}	Propagation Delay, Enable T to Ripple carry		14	ns
t_{PHL}	Propagation Delay, Enable T to Ripple carry		14	ns
t_{PHL}	Propagation Delay, Reset to Any Q		28	ns

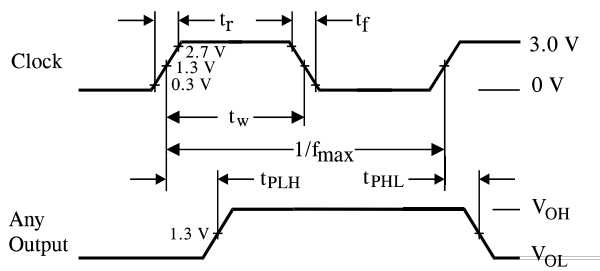

Figure 1. Switching Waveform

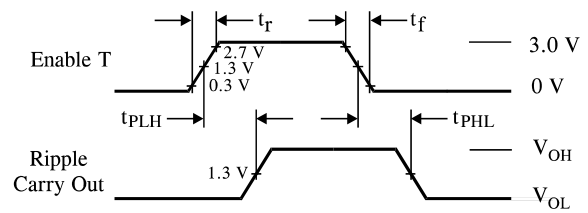

Figure 2. Switching Waveform

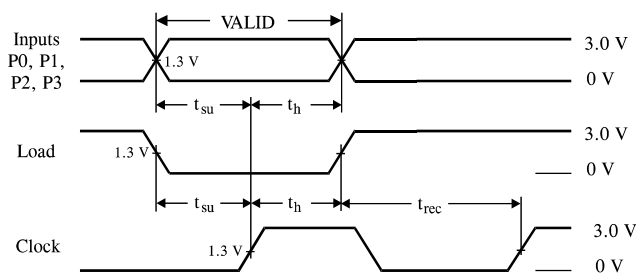

Figure 3. Switching Waveform

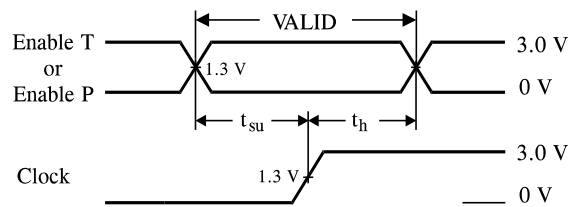
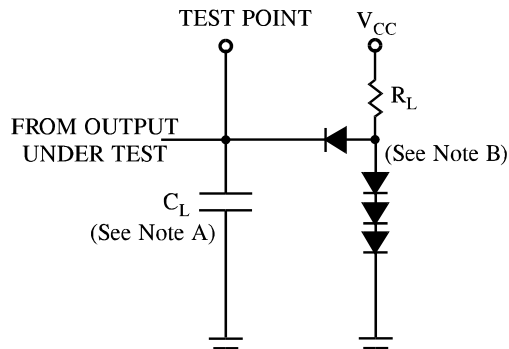
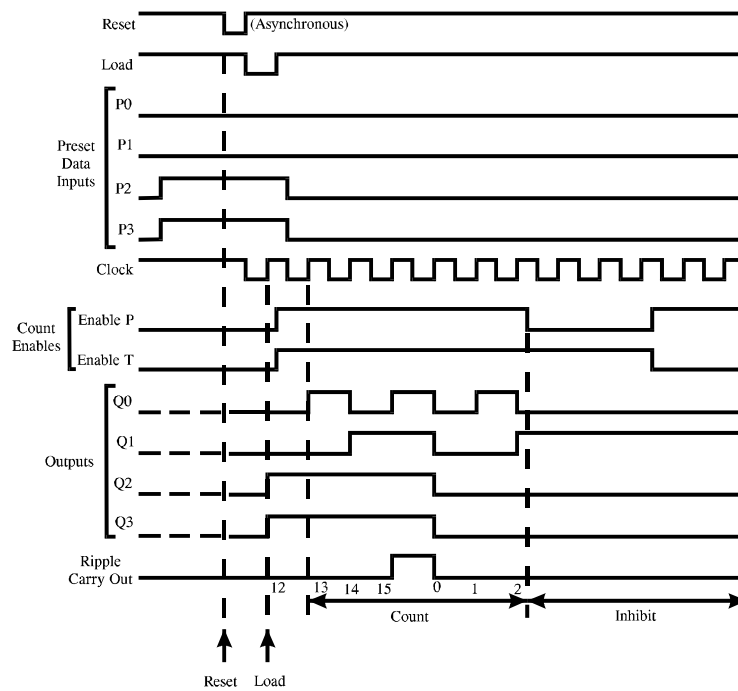

Figure 4. Switching Waveform



NOTES A. C_L includes probe and jig capacitance.
 B. All diodes are 1N916 or 1N3064.

Figure 5. Test Circuit



Sequence illustrated in waveforms:

1. Reset outputs to zero.
2. Preset to binary twelve.
3. Count to thirteen, fourteen, fifteen, zero, one, and two.
4. Inhibit.

Figure 7. Timing Diagram

**N SUFFIX PLASTIC DIP
(MS - 001BB)**



$\oplus 0.25 (0.010) \text{ (M) T}$

NOTES:

- Dimensions "A", "B" do not include mold flash or protrusions.
Maximum mold flash or protrusions 0.25 mm (0.010) per side.

Symbol	Dimension, mm	
	MIN	MAX
A	18.67	19.69
B	6.1	7.11
C		5.33
D	0.36	0.56
F	1.14	1.78
G	2.54	
H	7.62	
J	0°	10°
K	2.92	3.81
L	7.62	8.26
M	0.2	0.36
N	0.38	

**D SUFFIX SOIC
(MS - 012AC)**

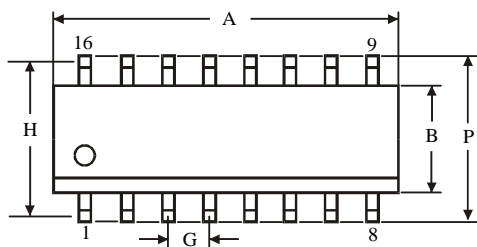

$\oplus 0.25 (0.010) \text{ (M) T C (M)}$

NOTES:

- Dimensions A and B do not include mold flash or protrusion.
- Maximum mold flash or protrusion 0.15 mm (0.006) per side for A; for B - 0.25 mm (0.010) per side.

Symbol	Dimension, mm	
	MIN	MAX
A	9.8	10
B	3.8	4
C	1.35	1.75
D	0.33	0.51
F	0.4	1.27
G	1.27	
H	5.72	
J	0°	8°
K	0.1	0.25
M	0.19	0.25
P	5.8	6.2
R	0.25	0.5