



EVERLIGHT ELECTRONICS CO., LTD.

DATA SHEET

Part No. : 67-03/BHGHR6W-B11/2T

Date : 2007.09.21

Department : RD3

Revision : 1.1

Received	
<input type="checkbox"/>	MASS PRODUCTION
<input checked="" type="checkbox"/>	PRELIMINARY
<input type="checkbox"/>	CUSTOMER DESIGN
PAGE : 14	

Revised record		
REV.	DESCRIPTION	RELEASE DATE
1.1	New Spec.	2007.9.21

OFFICE:..NO.25,LANE76,SEC.3,CHUNG YANG RD.,TUCHENG 236,TAIPEI,TAIWAN,R.O.C

TEL : 886-2-22672000

FAX : 886-2-22676244

<http://www.everlight.com>



Technical Data Sheet - Preliminary

Full Color Top View LEDs

67-03/BHGHR6W-B11/2T

Features

- P-LCC-4 package.
- White package and black surface.
- Optical indicator.
- Colorless clear window.
- Ideal for backlight and light pipe application.
- Inter reflector.
- Wide viewing angle.
- Suitable for vapor-phase reflow, Infrared reflow and wave solder processes.
- Computable with automatic placement equipment.
- Available on tape and reel (8mm Tape).
- Pb-free.
- The product itself will remain with RoHS compliant version



Descriptions

- The 67-03 series is available in soft orange, green, blue and yellow. Due to the package design, the LED has wide viewing angle and optimized light coupling by inter reflector. This feature makes the LED ideal for light pipe application. The low current requirement makes this device ideal for portable equipment or any other application where power is at a premium.

Applications

- Telecommunication: indicator and backlighting in telephone and fax.
- Flat backlight for LCD's, switches and symbols.
- Light pipe application.
- General use.

Device Selection Guide

Chip		Emitted Color	Resin Color
Type	Material		
R6	AlGaInP	Brilliant Red	White Diffuse
GH	InGaN	Brilliant Green	
BH	InGaN	Blue	

Technical Data Sheet - Preliminary

Full Color Top View LEDs

67-03/BHGHR6W-B11/2T

Package Outline Dimensions

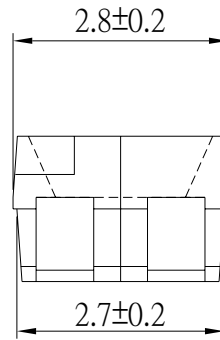
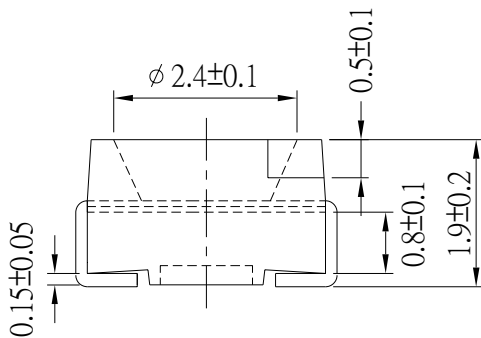
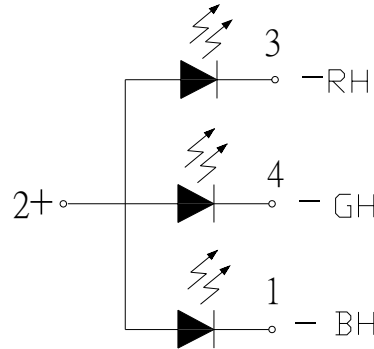
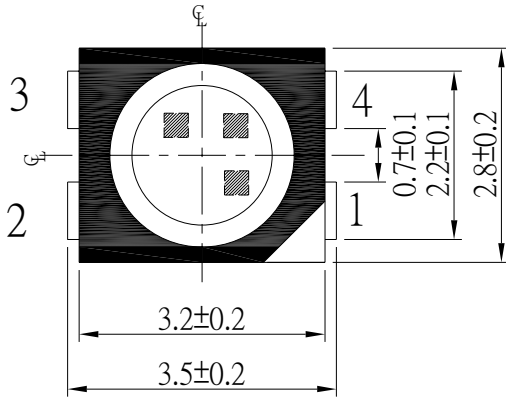

Recommended soldering pad design

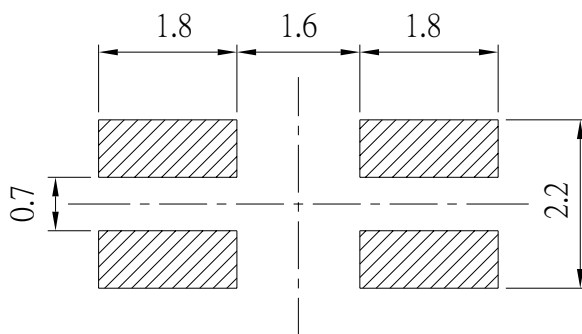
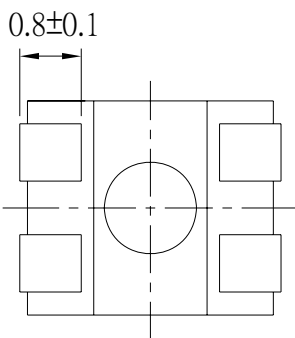

Notes:

1. All dimensions are in millimeters
2. Tolerance unless mentioned is ± 0.1 mm

**Technical Data Sheet - Preliminary****Full Color Top View LEDs****67-03/BHGHR6W-B11/2T****Absolute Maximum Ratings (Ta=25°C)**

Parameter	Symbol	Rating		Unit
Reverse Voltage	V_R	5		V
Forward Current	I_F	R6	50	mA
		GH	25	
		BH	25	
Peak Forward Current (Duty 1/10 @ 1KHz)	I_{FP}	R6	100	mA
		GH	100	
		BH	100	
Power Dissipation	P_d	R6	120	mW
		GH	110	
		BH	110	
Electrostatic Discharge(HBM)	ESD	R6	2000	V
		GH	150	
		BH	150	
Operating Temperature	T_{opr}	-40 ~ +85		°C
Storage Temperature	T_{stg}	-40~ +90		°C
Soldering Temperature	T_{sol}	Reflow Soldering : 260 °C for 10 sec. Hand Soldering : 350 °C for 3 sec.		



Technical Data Sheet - Preliminary

Full Color Top View LEDs

67-03/BHGHR6W-B11/2T

Electro-Optical Characteristics (Ta=25°C)

Parameter	Symbol	Min.	Typ.	Max.	Unit	Condition	
Luminous Intensity	I _v	R6	200	-----	345	mcd	I _F =20mA
		GH	500	-----	860		
		BH	165	-----	285		
Peak Wavelength	λ _p	R6	-----	632	-----	nm	I _F =20mA
		GH	-----	518	-----		
		BH	-----	468	-----		
Dominant Wavelength	λ _d	R6	619	-----	628	nm	I _F =20mA
		GH	525	-----	532.5		
		BH	465	-----	472.5		
Spectrum Radiation Bandwidth	Δλ	R6	-----	20	-----	nm	I _F =20mA
		GH	-----	35	-----		
		BH	-----	35	-----		
Forward Voltage	V _F	R6	1.75	-----	2.35	V	I _F =20mA
		GH	2.9	-----	3.5		
		BH	2.9	-----	3.5		
Viewing Angle	2θ _{1/2}	-----	120	-----	deg	I _F =20mA	
Reverse Current	I _R	R6	-----	-----	10	μA	V _R =5V
		GH	-----	-----	50		
		BH	-----	-----	50		

Note:

1. Tolerance of Luminous Intensity: ±11%
2. Tolerance of Dominant Wavelength: ±1nm
3. Tolerance of Forward Voltage: ±11%

**Technical Data Sheet - Preliminary****Full Color Top View LEDs****67-03/BHGHR6W-B11/2T****Bin Range of Luminous Intensity**

Symbol		Bin Code	Min.	Max.	Unit	Condition
I _v	R6	6	200	240	mcd	I _F =20mA
		7	240	285		
		8	285	345		
	GB	11	500	600		
		12	600	720		
		13	720	860		
	B7	5	165	200		
		6	200	240		
		7	240	285		

Bin Range of Dominant Wavelength

Symbol		Bin Code	Min.	Max.	Unit	Condition
λ _d	RS	R1	619	622	nm	I _F =20mA
		R2	622	625		
		R3	625	628		
	GB	G1	525	527.5		
		G2	527.5	530		
		G3	530	532.5		
	B7	B1	465	467.5		
		B2	467.5	470		
		B3	470	472.5		

Note:

1. Tolerance of Luminous Intensity: ±11%
2. Tolerance of Dominant Wavelength: ±1nm

**Technical Data Sheet - Preliminary****Full Color Top View LEDs****67-03/BHGHR6W-B11/2T****Bin Range of Forward Voltage**

Symbol		Bin Code	Min.	Max.	Unit	Condition
V _F	RS	0	1.75	1.95	V	I _F = 20mA
		1	1.95	2.15		
		2	2.15	2.35		
	GB	11	2.90	3.10		
		12	3.10	3.30		
		13	3.30	3.50		
	B7	11	2.90	3.10		
		12	3.10	3.30		
		13	3.30	3.50		

Note:

1. Tolerance of Forward Voltage: $\pm 11\%$



Technical Data Sheet - Preliminary

Full Color Top View LEDs

67-03/BHGHR6W-B11/2T

Typical Electro-Optical Characteristics Curves (BH)

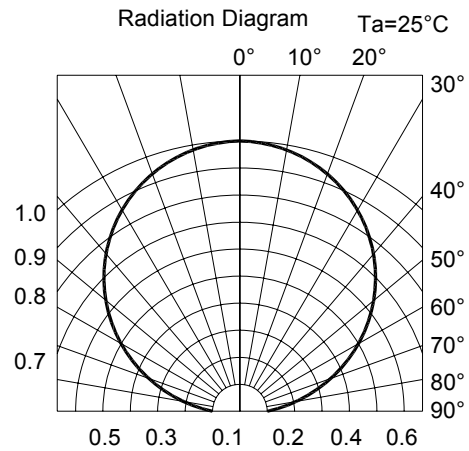
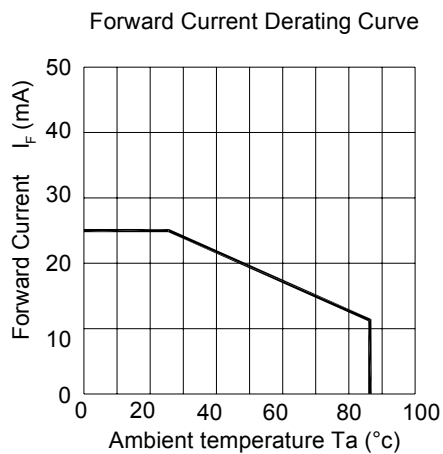
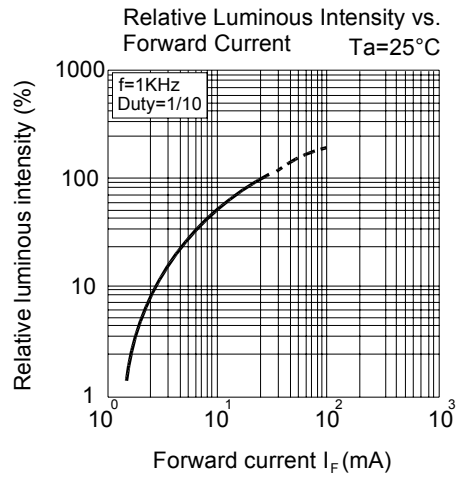
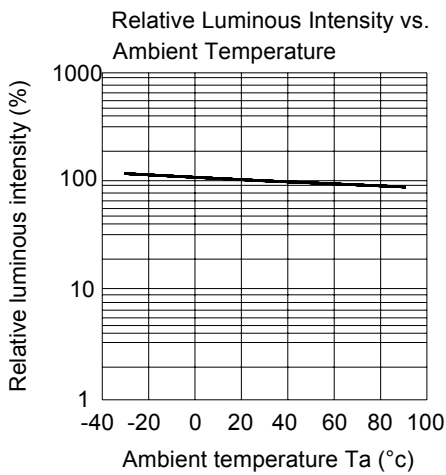
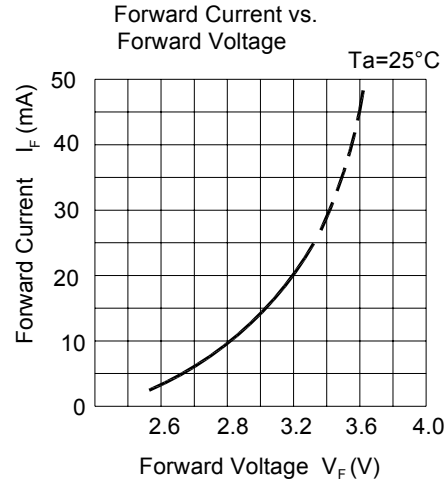
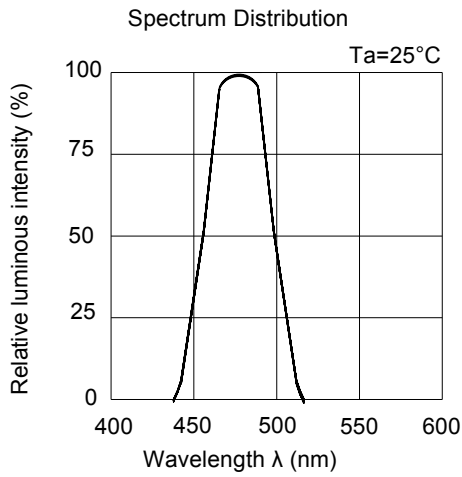



Technical Data Sheet - Preliminary

Full Color Top View LEDs

67-03/BHGHR6W-B11/2T

Typical Electro-Optical Characteristics Curves (GB)

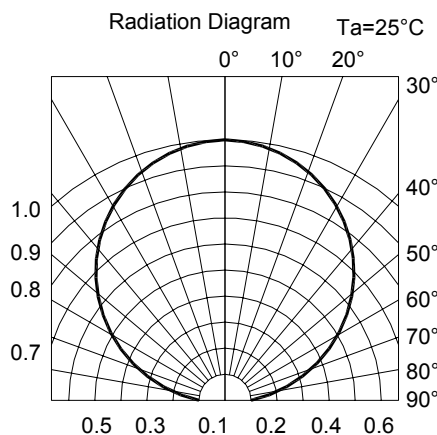
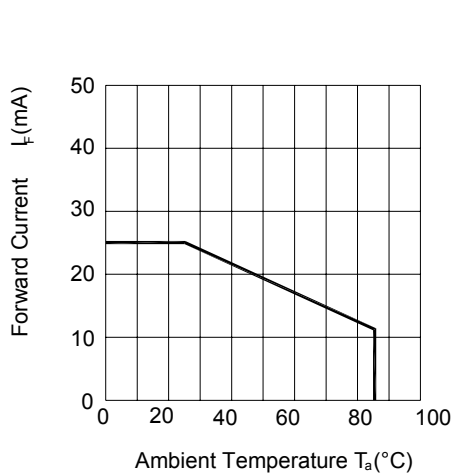
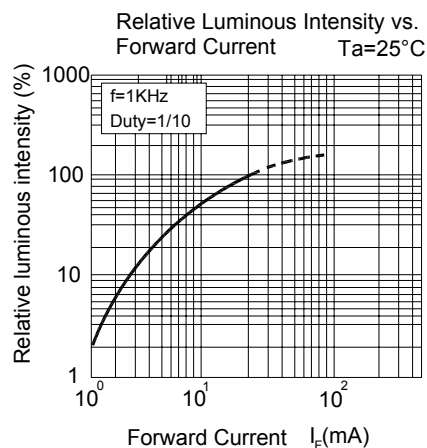
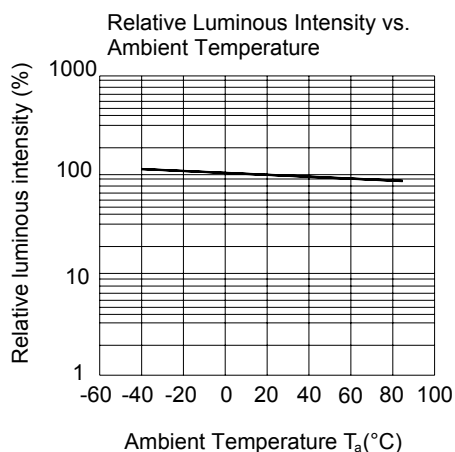
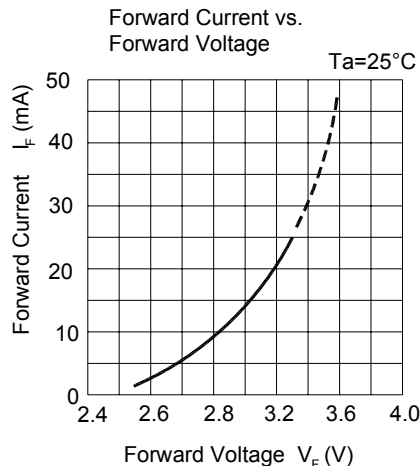
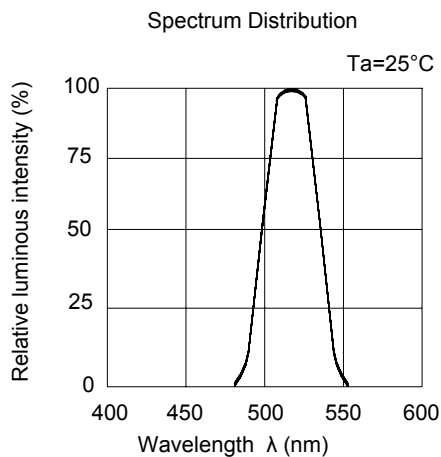



Technical Data Sheet - Preliminary

Full Color Top View LEDs

67-03/BHGHR6W-B11/2T

Typical Electro-Optical Characteristics Curves (RS)

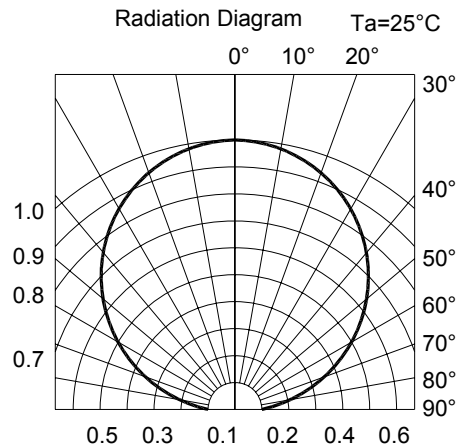
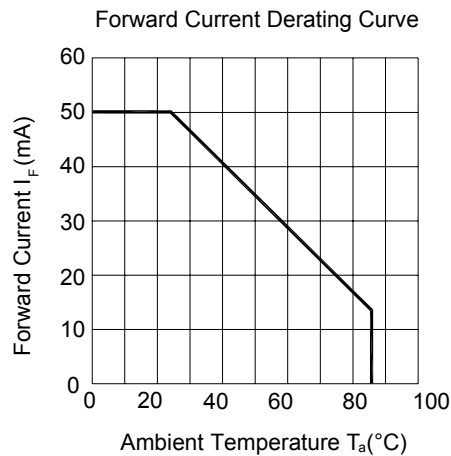
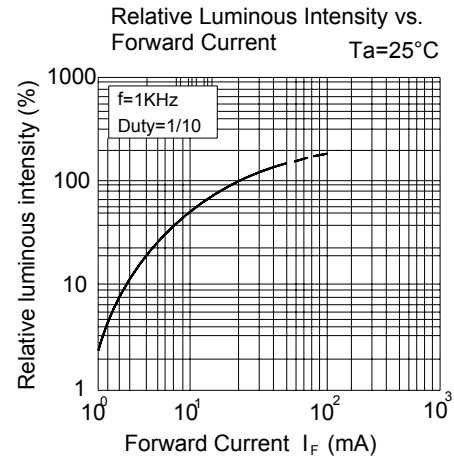
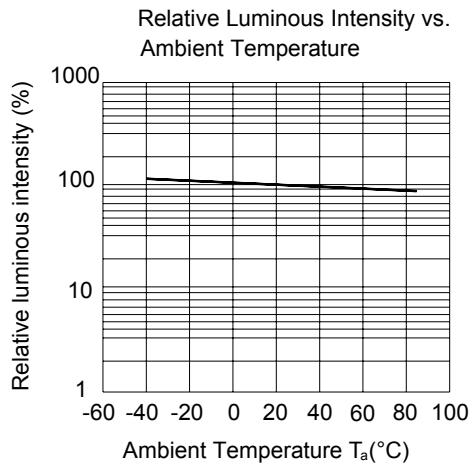
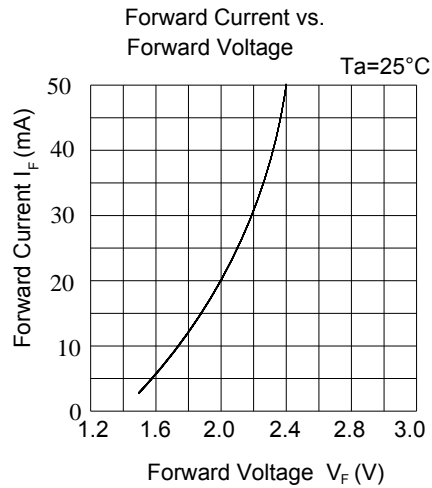
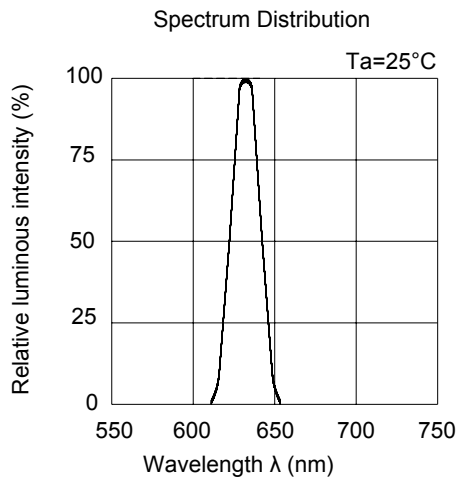



Technical Data Sheet - Preliminary

Full Color Top View LEDs

67-03/BHGHR6W-B11/2T

Label Explanation

CAT: Luminous Intensity Rank

HUE: Dom. Wavelength Rank

REF: Forward Voltage Rank

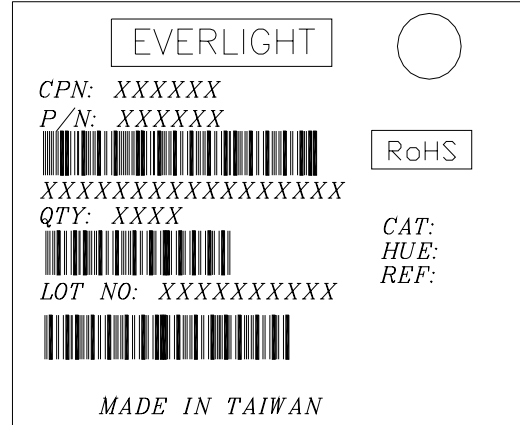

Reel Dimensions

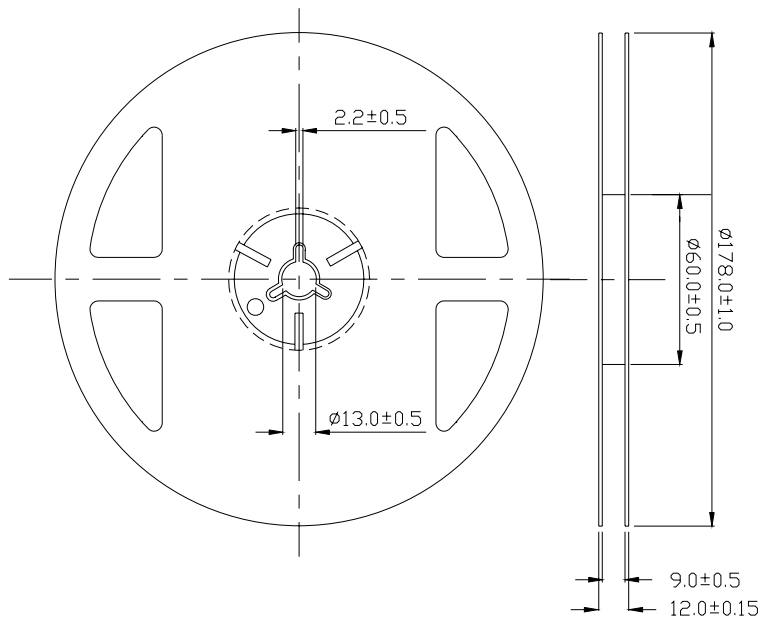

Note: Tolerance unless mentioned is ±0.1mm; Unit = mm



Technical Data Sheet - Preliminary

Full Color Top View LEDs

67-03/BHGHR6W-B11/2T

Carrier Tape Dimensions: Loaded Quantity 2000 pcs Per Reel.

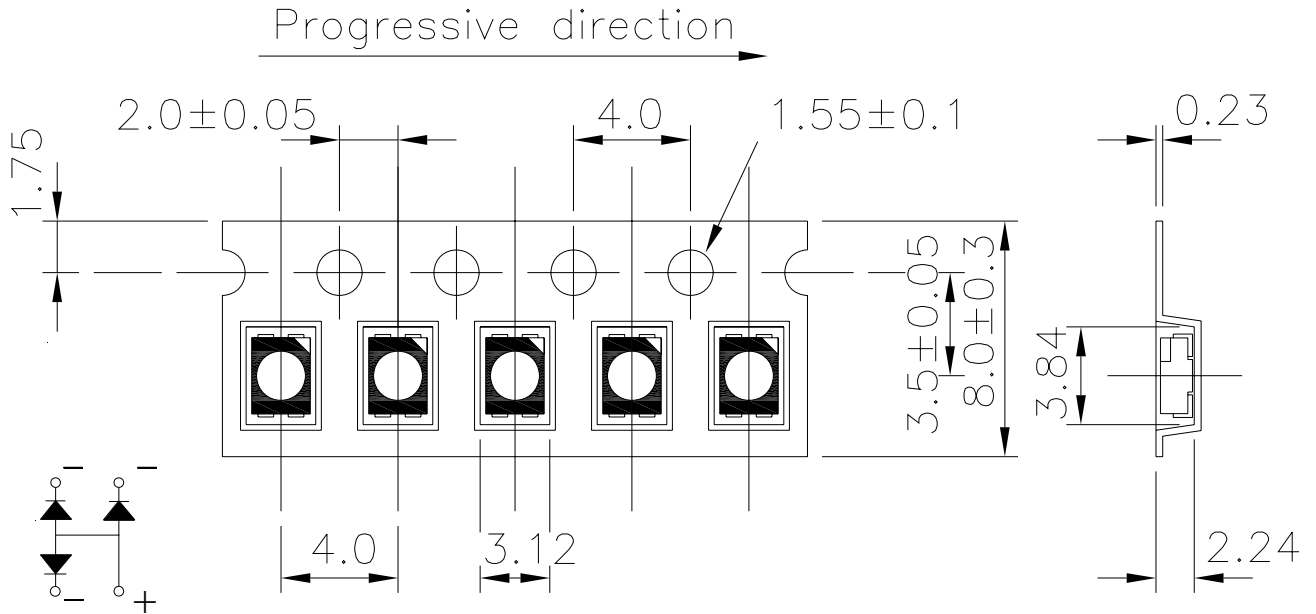

Note: Tolerance unless mentioned is ±0.1mm; Unit = mm

Moisture Resistant Packaging

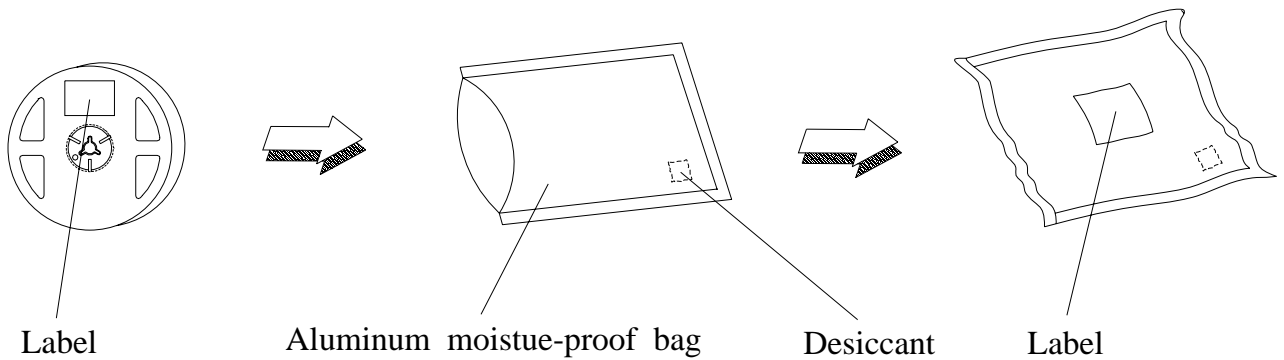

**Technical Data Sheet - Preliminary****Full Color Top View LEDs****67-03/BHGHR6W-B11/2T****Reliability Test Items and Conditions**

The reliability of products shall be satisfied with items listed below.

Confidence level : 90%

LTPD : 10%

No.	Items	Test Condition	Test Hours/Cycles	Sample Size	Ac/Re
1	Reflow Soldering	Temp. : 260°C±5°C Min. 5sec.	6 Min.	22 PCS.	0/1
2	Temperature Cycle	H : +100°C 15min ∫ 5 min L : -40°C 15min	300 Cycles	22 PCS.	0/1
3	Thermal Shock	H : +100°C 5min ∫ 10 sec L : -10°C 5min	300 Cycles	22 PCS.	0/1
4	High Temperature Storage	Temp. : 100°C	1000 Hrs.	22 PCS.	0/1
5	Low Temperature Storage	Temp. : -40°C	1000 Hrs.	22 PCS.	0/1
6	DC Operating Life	I _F = 20 mA	1000 Hrs.	22 PCS.	0/1
7	High Temperature / High Humidity	85°C / 85%RH	1000 Hrs.	22 PCS.	0/1



Technical Data Sheet - Preliminary

Full Color Top View LEDs

67-03/BHGHR6W-B11/2T

Precautions for Use

1. Over-current-proof

Customer must apply resistors for protection; otherwise slight voltage shift will cause big current change (Burn out will happen).

2. Storage

2.1 Do not open moisture proof bag before the products are ready to use.

2.2 Before opening the package: The LEDs should be kept at 30°C or less and 90%RH or less.

2.3 After opening the package: The LED's floor life is 1 year under 30°C or less and 60% RH or less. If unused LEDs remain, it should be stored in moisture proof packages.

2.4 If the moisture absorbent material (silica gel) has faded away or the LEDs have exceeded the storage time, baking treatment should be performed using the following conditions.

Baking treatment: 60±5°C for 24 hours.

3. Soldering Condition

3.1 Pb-free solder temperature profile

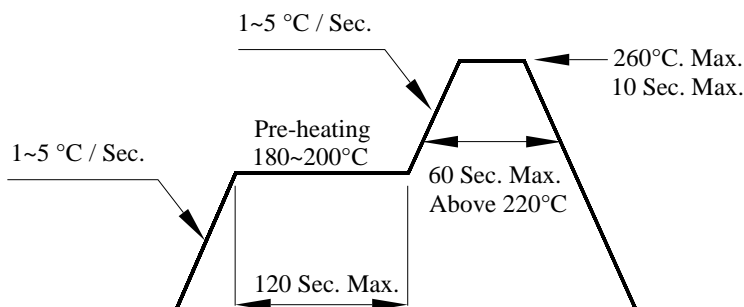

3.2 Reflow soldering should not be done more than two times.

3.3 When soldering, do not put stress on the LEDs during heating.

3.4 After soldering, do not warp the circuit board.

Technical Data Sheet - Preliminary**Full Color Top View LEDs****67-03/BHGHR6W-B11/2T****4. Soldering Iron**

Each terminal is to go to the tip of soldering iron temperature less than 350°C for 3 seconds within once in less than the soldering iron capacity 25W. Leave two seconds and more intervals, and do soldering of each terminal. Be careful because the damage of the product is often started at the time of the hand solder.

5. Repairing

Repair should not be done after the LEDs have been soldered. When repairing is unavoidable, a double-head soldering iron should be used (as below figure). It should be confirmed beforehand whether the characteristics of the LEDs will or will not be damaged by repairing.

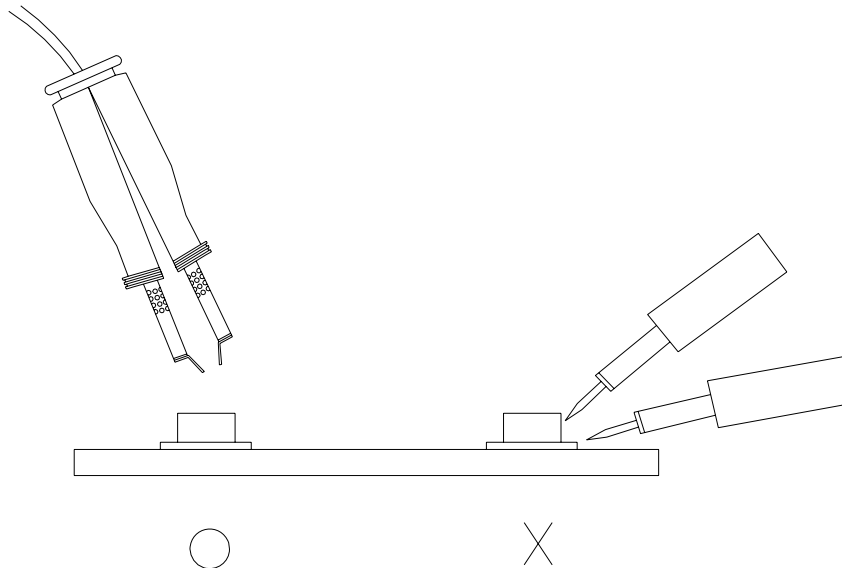

EVERLIGHT ELECTRONICS CO., LTD.
Office: No 25, Lane 76, Sec 3, Chung Yang Rd,
Tucheng, Taipei 236, Taiwan, R.O.C

Tel: 886-2-2267-2000, 2267-9936
Fax: 886-2267-6244, 2267-6189, 2267-6306
<http://www.everlight.com>