

### PRELIMINARY SPEC

Part Number: AA3020ARWC/A

WHITE



**ATTENTION**  
OBSERVE PRECAUTIONS  
FOR HANDLING  
ELECTROSTATIC  
DISCHARGE  
SENSITIVE  
DEVICES

### Features

- 3.0MM X 2.0MM, 1.4MM HIGH, ONLY MINIMUM SPACE REQUIRED.
- SUITABLE FOR COMPACT OPTOELECTRONIC APPLICATIONS.
- LOW POWER CONSUMPTION.
- PACKAGE : 2000PCS / REEL.
- MOISTURE SENSITIVITY LEVEL : LEVEL 4.
- ELECTROSTATIC DISCHARGE THRESHOLD (HBM):1000V.
- TYP. COLOR TEMPERATURE:6500K
- COLOR COORDINATES:X=0.31,Y=0.31 ACC. TO CIE1931(WHITE).
- OPTICAL EFFICIENCY:9.5 lm/W(TYP.)
- COLOR REPRODUCTION INDEX:80.
- RoHS COMPLIANT.

### Description

The source color devices are made with InGaN on SiC Light Emitting Diode.

Static electricity and surge damage the LEDs.

It is recommended to use a wrist band or anti-electrostatic glove when handling the LEDs.

All devices, equipment and machinery must be electrically grounded.

### Applications

- traffic signaling.
- backlighting (illuminated advertising , general lighting).
- interior and exterior automotive lighting.
- substitution of micro incandescent lamps.
- reading lamps.
- signal and symbol luminaire for orientation.
- marker lights (e.g. steps, exit ways, etc).
- decorative and entertainment lighting.
- indoor and outdoor commercial and residential architectural lighting.

### Package Dimensions

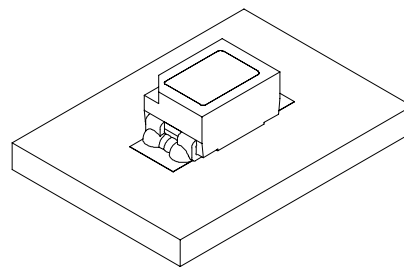
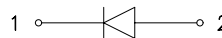
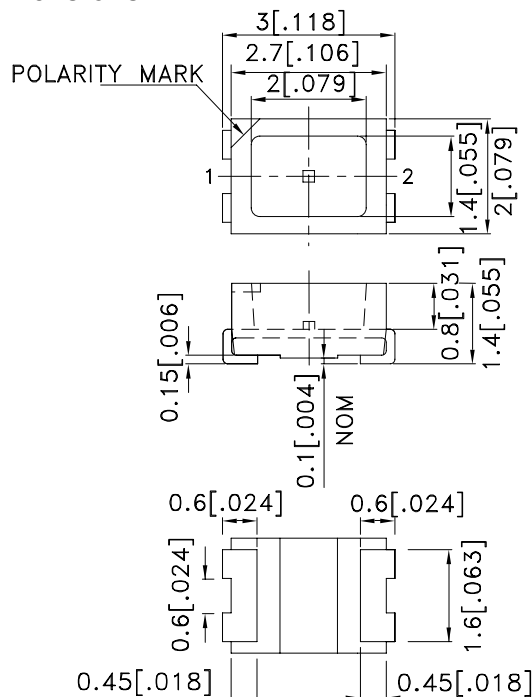

#### Notes:

1. All dimensions are in millimeters (inches).
2. Tolerance is  $\pm 0.25(0.01)$  unless otherwise noted.
3. Specifications are subject to change without notice.
4. The device has a single mounting surface. The device must be mounted according to the specifications.



## Selection Guide

Part No.	Dice	Lens Type	luminous Intensity <sup>Note2</sup> Iv(mcd) @ 20 mA		$\Phi_v$ (mlm) <sup>Note3</sup> @ 20 mA	Viewing Angle <sup>Note1</sup>
			Min.	Typ.	Typ.	2 $\theta$ 1/2
AA3020ARWC/A	WHITE (InGaN)	WATER CLEAR	70	125	630	90°

## Absolute Maximum Ratings at TA=25°C

Parameter	Symbol	Value	Unit
Power dissipation	Pt	120	mW
Reverse Voltage	VR	5	V
Junction temperature	TJ	110	°C
Operating Temperature	Top	-40 To +85	°C
Storage Temperature	Tstg	-40 To +100	°C
DC Forward Current	IF	30	mA
Peak Forward Current <sup>Note4</sup>	IFM	100	mA
Thermal resistance Junction/ambient <sup>Note5</sup>	Rth JA	300	°C/W
Junction/solder point	Rth JS	140	°C/W

Notes:

1. $\theta$ 1/2 is the angle from optical centerline where the luminous intensity is 1/2 the optical centerline value.
- 2.Luminous intensity is measured by a current pulse of 10ms at a tolerance of  $\pm 15\%$ .
- 3.The typical data of Luminous Flux can only reflect statistical figures, actual parameters of individual product could differ from the typical data.  
For the purpose of product enhancement, the typical data is subject to change without prior notice.
- 4.1/10 Duty Cycle, 0.1ms Pulse Width.
- 5.Rth(J-A) Results from mounting on PC board FR4 (pad size  $\geq 16 \text{ mm}^2$  per pad),

## Electrical / Optical Characteristics at TA=25°C

Parameter	Symbol	Value	Unit
Chromaticity coordinate x acc.to CIE1931 IF=20mA [Typ.]	X <sup>Note1</sup>	0.31	-
Chromaticity coordinate y acc.to CIE1931 IF=20mA [Typ.]	Y <sup>Note1</sup>	0.31	-
Forward Voltage IF=20mA [Min.]	VF <sup>Note2</sup>	2.7	V
Forward Voltage IF=20mA [Typ.]		3.2	
Forward Voltage IF=20mA [Max.]		4.0	
Reverse Current (VR=5V) [Typ.]	IR	0.01	$\mu\text{A}$
Reverse Current (VR=5V) [Max.]		10	
Temperature coefficient of x IF=20mA, $-10^\circ\text{C} \leq T \leq 100^\circ\text{C}$ [Typ.]	TCx	-0.1	$10^{-3}/^\circ\text{C}$
Temperature coefficient of y IF=20mA, $-10^\circ\text{C} \leq T \leq 100^\circ\text{C}$ [Typ.]	TCy	-0.2	$10^{-3}/^\circ\text{C}$
Temperature coefficient of VF IF=20mA, $-10^\circ\text{C} \leq T \leq 100^\circ\text{C}$ [Typ.]	TCv	-2.5	mV/°C

Notes:

- 1.Chromaticity coordinates are measured by a current pulse of 20ms with a tolerance of  $\pm 0.01$  in X and Y color coordinates.
- 2.Forward voltage is measured with a current pulse of 10ms at a tolerance of  $\pm 0.1V$ .

## Brightness codes

Code.	Luminous Intensity <sup>Note1</sup> Iv(mcd) @ 20mA		$\Phi_v$ (mlm) <sup>Note2</sup> @ 20mA
	Min.	Max.	Typ.
M	70	130	480
N	110	220	710
P	180	320	960
Q	280	420	1270

Notes:

- Luminous intensity is measured by a current pulse of 10ms at a tolerance of  $\pm 15\%$ .
- The typical data of Luminous Flux can only reflect statistical figures, actual parameters of individual product could differ from the typical data. For the purpose of product enhancement, the typical data is subject to change without prior notice.

## White

### AA3020ARWC/A

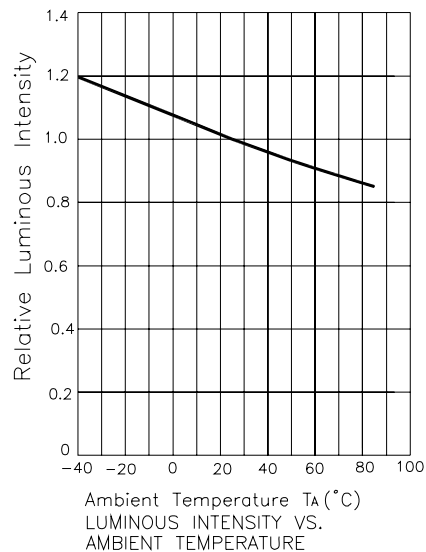
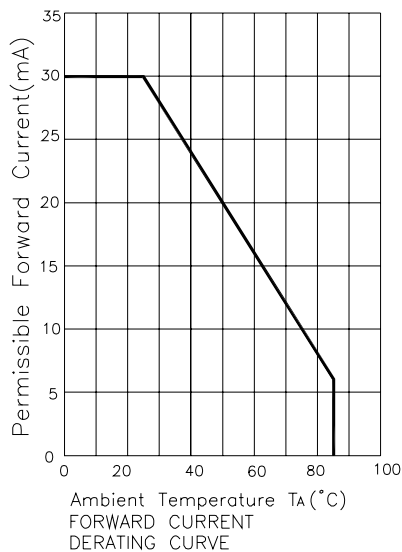
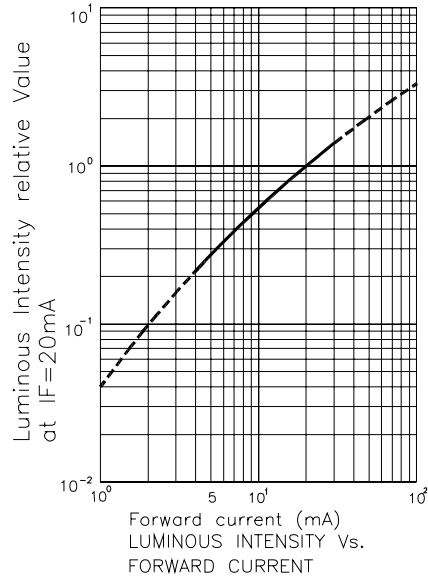
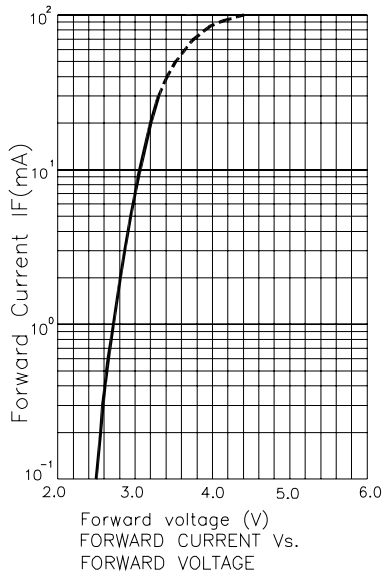

White

AA3020ARWC/A

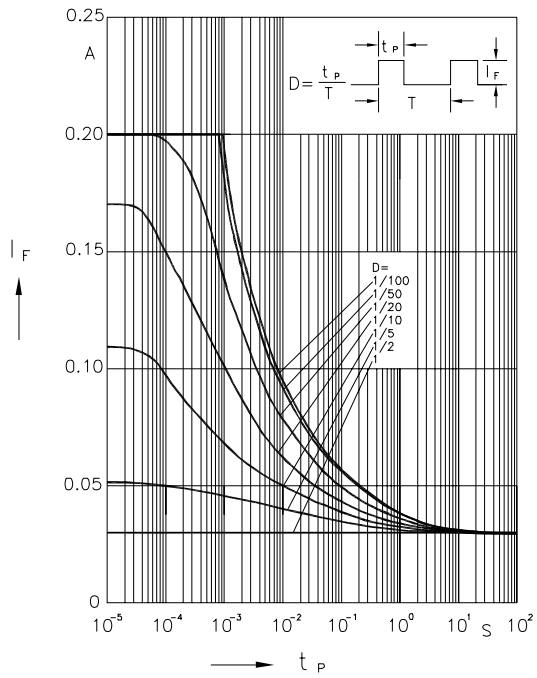

Permissible Pulse Handling Capability  
Duty cycle  $D = \text{parameter}$ ,  $T_A = 25^\circ\text{C}$

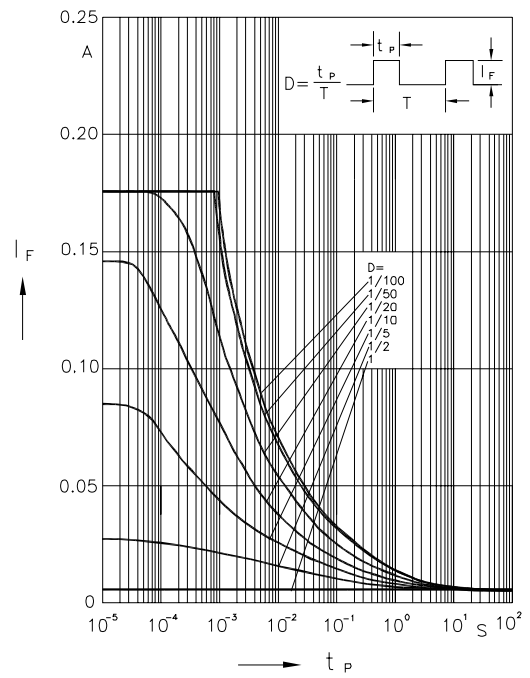

Permissible Pulse Handling Capability  
Duty cycle  $D = \text{parameter}$ ,  $T_A = 85^\circ\text{C}$

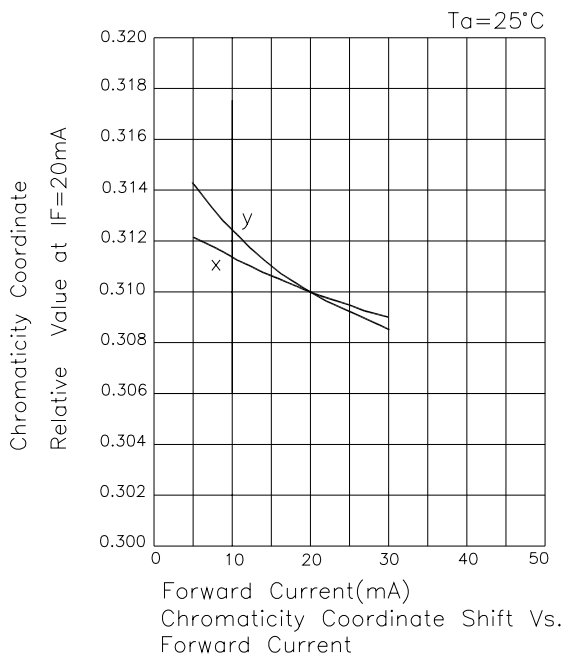

Chromaticity Coordinate  
Relative Value at  $I_F = 20\text{mA}$   
Forward Current (mA)  
Chromaticity Coordinate Shift Vs.  
Forward Current

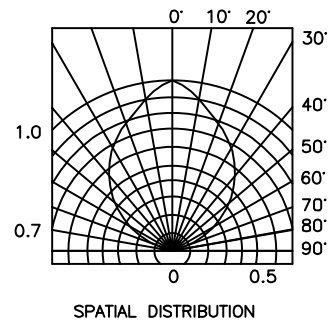
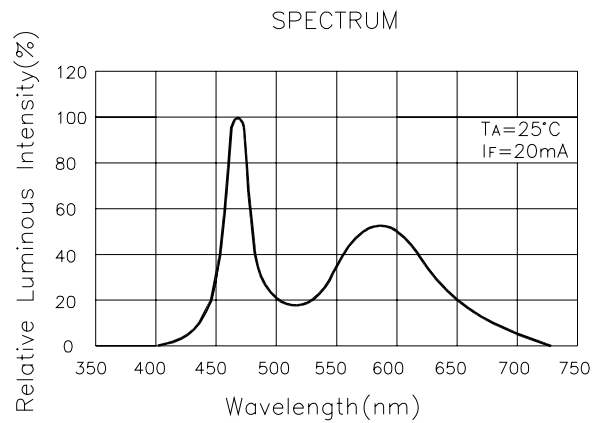

SPATIAL DISTRIBUTION

AA3020ARWC/A

## White CIE

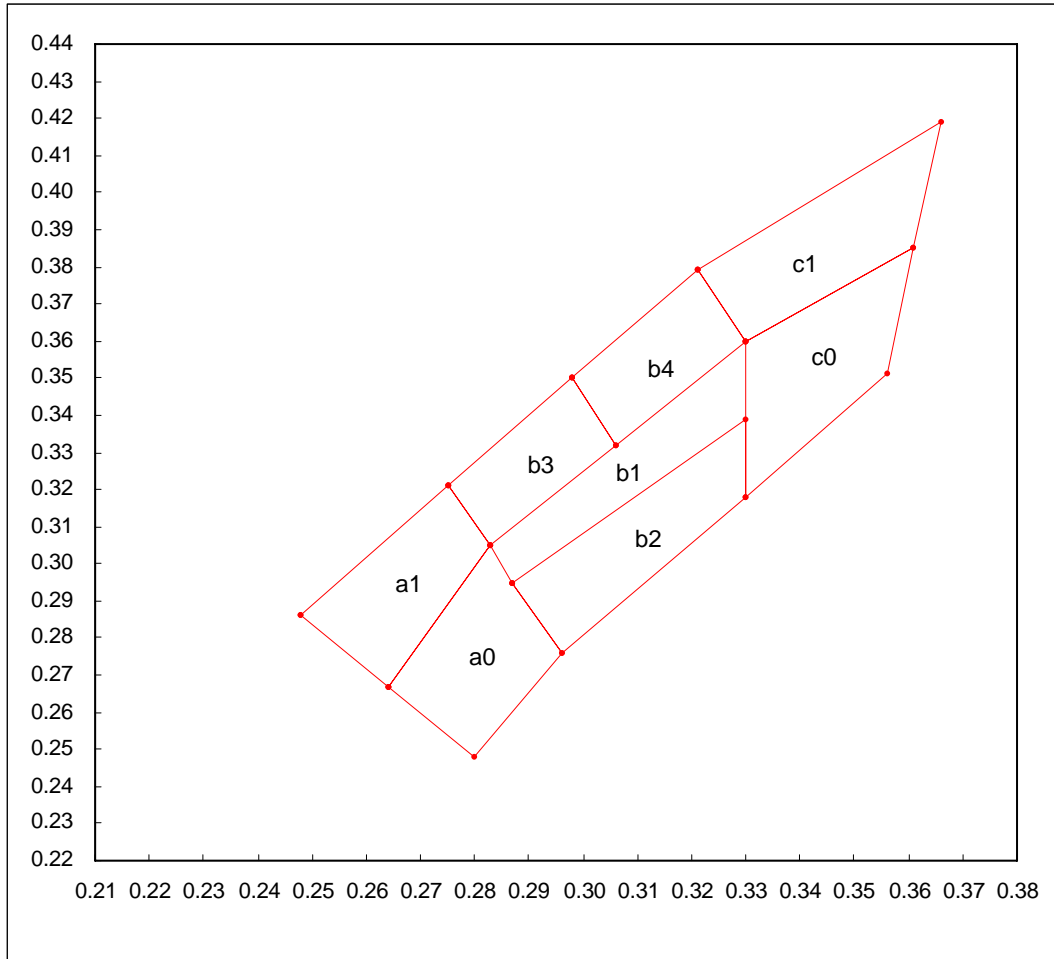

a0				
X	0.264	0.283	0.296	0.280
Y	0.267	0.305	0.276	0.248
Reference CCT: 14000~9000k				

a1				
X	0.248	0.275	0.283	0.264
Y	0.286	0.321	0.305	0.267
Reference CCT: 14000~9000k				

b1				
X	0.283	0.330	0.330	0.287
Y	0.305	0.360	0.339	0.295
Reference CCT: 9000~5600k				

b2				
X	0.287	0.330	0.330	0.296
Y	0.295	0.339	0.318	0.276
Reference CCT: 9000~5600k				

b3				
X	0.275	0.298	0.306	0.283
Y	0.321	0.350	0.332	0.305
Reference CCT: 9000~7000k				

b4				
X	0.298	0.321	0.330	0.306
Y	0.350	0.379	0.360	0.332
Reference CCT: 7600~5600k				

c0				
X	0.330	0.361	0.356	0.330
Y	0.360	0.385	0.351	0.318
Reference CCT: 5600~4600k				

c1				
X	0.321	0.366	0.361	0.330
Y	0.379	0.419	0.385	0.360
Reference CCT: 6000~4600k				

## AA3020ARWC/A

Reflow Soldering Profile For Lead-free SMT Process.

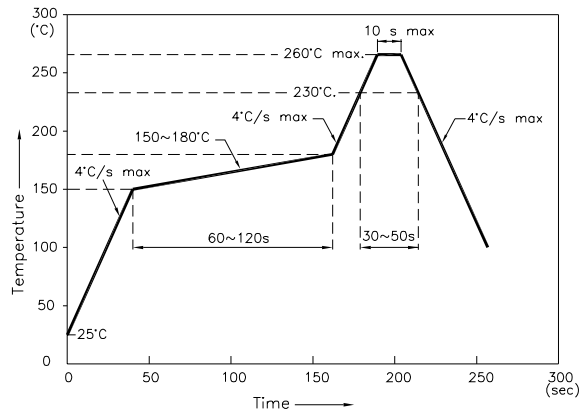

**NOTES:**

1. We recommend the reflow temperature 245°C(+/-5°C). The maximum soldering temperature should be limited to 260°C.
2. Don't cause stress to the epoxy resin while it is exposed to high temperature.
3. Number of reflow process shall be 2 times or less.

### Recommended Soldering Pattern (Units : mm; Tolerance: ±0.1)

Pad design for improved heat dissipation

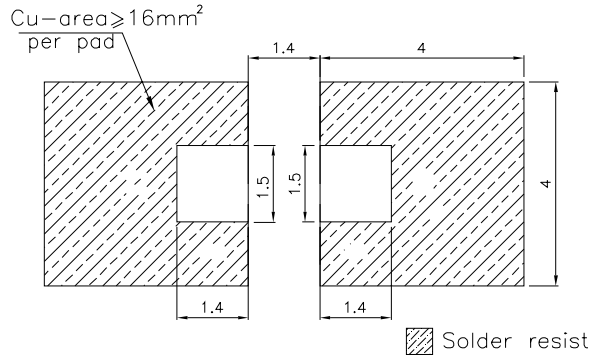
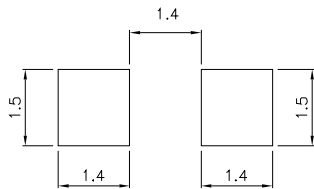

### Tape Specifications (Units : mm)

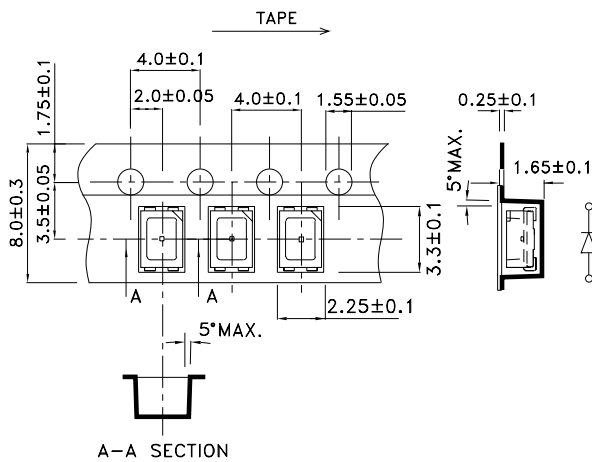

### Reel Dimension

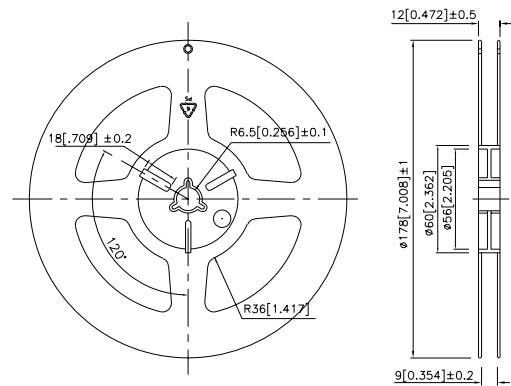

# Kingbright

## PACKING & LABEL SPECIFICATIONS

## AA3020ARWC/A

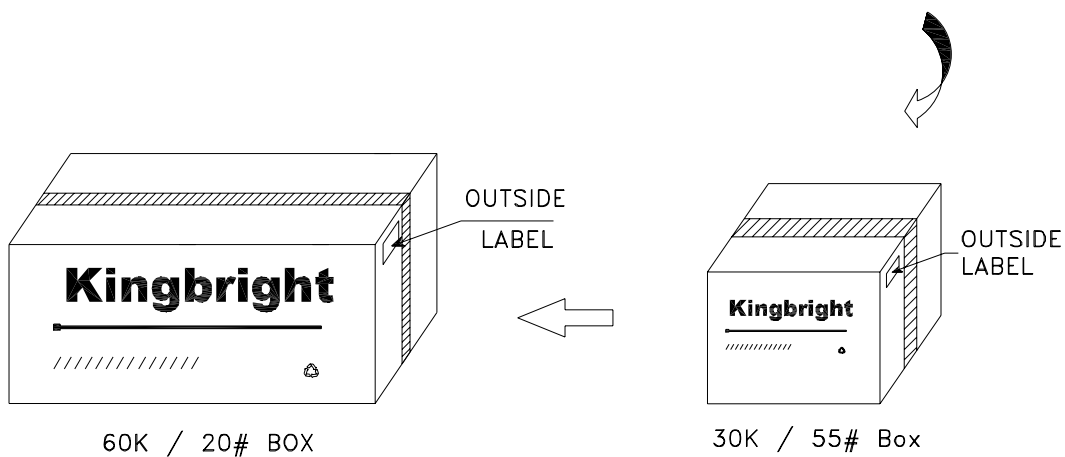
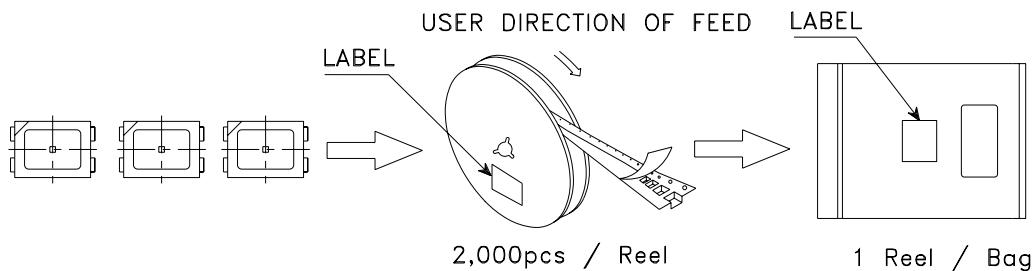

<h1>Kingbright</h1>	
P/NO: AA3020Axxx	
QTY: 2,000 pcs	Q.C. <span style="border: 1px solid black; border-radius: 50%; padding: 2px;">Q C xx xx xxxx PASSED</span>
S/N: XXXX	
CODE: XXX	
LOT NO:	
 xxxxxxxxxxxxxxxxxxxxxxxxxxxx	
RoHS Compliant	