



# Specification CAWT722-S

SSC		CUSTOMER
Drawn	Approval	Approval

# CONTENTS

1. Feature & Application
2. Absolute Maximum Ratings
3. Electro Characteristics
4. Optical characteristics
5. Color & Binning
6. Rank of CAWT722-S
7. Outline Dimension
8. Packing
9. Soldering
10. Precaution for use
11. Handling of Silicone Resin LEDs
12. Reliability Test Item and Condition

# CAWT722-S

## Description

This surface-mount LED comes in PLCC standard package dimension. It has a substrate made up of a molded plastic reflector sitting on top of a bent lead frame. The die is attached within the reflector cavity and the cavity is encapsulated by epoxy or silicone.

The package design coupled with careful selection of component materials allow these products to perform with high reliability in a larger temperature range -40°C to 100°C. The high reliability feature is crucial to Automotive interior and Indoor ESS.

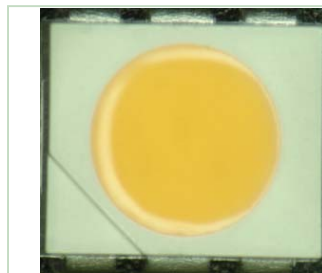

# CAWT722-S

## Features

- White colored SMT package.
- Material : InGaN/SiC
- Encapsulating Resin : Silicon Resin
- Suitable for all SMT assembly methods ; Suitable for all soldering methods
- RoHS Compliant

## Applications

- Interior automotive
- Office Automation, Electrical Appliances, Industrial Equipment

## 2. Absolute maximum ratings

Parameter	Symbol	Value	Unit
Power Dissipation	$P_d$	342	mW
Forward Current	$I_F$	90	mA
Peak Forward Current	$I_{FM}^{*2}$	100	mA
Reverse Voltage (per die)	$V_R$	5	V
Operating Temperature	$T_{opr}$	-40 ~ +85	°C
Storage Temperature	$T_{stg}$	-40 ~ +100	°C

\*1 Care is to be taken that power dissipation does not exceed the absolute maximum rating of the product.

\*2  $I_{FM}$  was measured at  $T_w \leq 1\text{msec}$  of pulse width and  $D \leq 1/10$  of duty ratio.

## 3. Electric & Optical characteristics

Parameter	Symbol	Condition	Min	Typ	Max	Unit
Forward Voltage (per die)	$V_F$	$I_F = 60\text{ mA}$	2.9	3.2	3.6	V
Reverse Current (per die)	$I_R$	$V_R = 5\text{V}$	-	-	10	$\mu\text{A}$
Luminance Intensity <sup>*1</sup>	$I_V$	$I_F = 60\text{ mA}$	-	4500	5500	mcd
Luminance Flux	$\Phi_V$	$I_F = 60\text{ mA}$	-	11	13.1	lm
Color Temperature	CCT	$I_F = 60\text{ mA}$	2500	-	4600	K
Color Coordinate	X	$I_F = 60\text{ mA}$	0.3545	-	0.4970	-
	Y		0.3408	-	0.4466	
Viewing Angle <sup>*2</sup>	$2\theta_{1/2}$	$I_F = 60\text{ mA}$	-	120	-	deg
Optical Efficiency	$\eta_{op}$	$I_F = 60\text{ mA}$	-	57	68	lm/W
Color Rendering Index	Ra	$I_F = 60\text{ mA}$	-	95		-

\*1. The luminous intensity  $I_V$  was measured at the peak of the spatial pattern which may not be aligned with the mechanical axis of the LED package. Luminous Intensity Measurement allowance is  $\pm 10\%$

\*2.  $2\theta_{1/2}$  is the off-axis where the luminous intensity is 1/2 of the peak intensity.

[Note] All measurements were made under the standardized environment of SSC.

### 4. Optical characteristics

Forward Current vs. Forward Voltage (per die)

( $T_a=25\text{ }^\circ\text{C}$ )

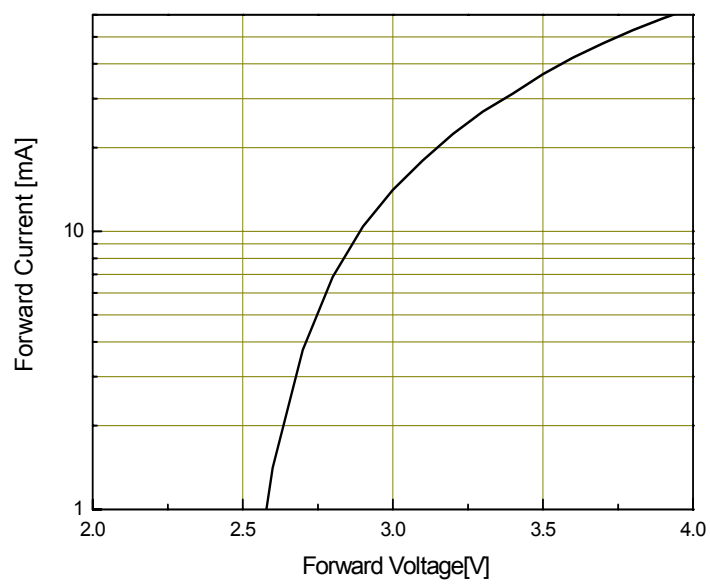

Relative Luminous Intensity vs Forward Current

( $T_a=25\text{ }^\circ\text{C}$ )

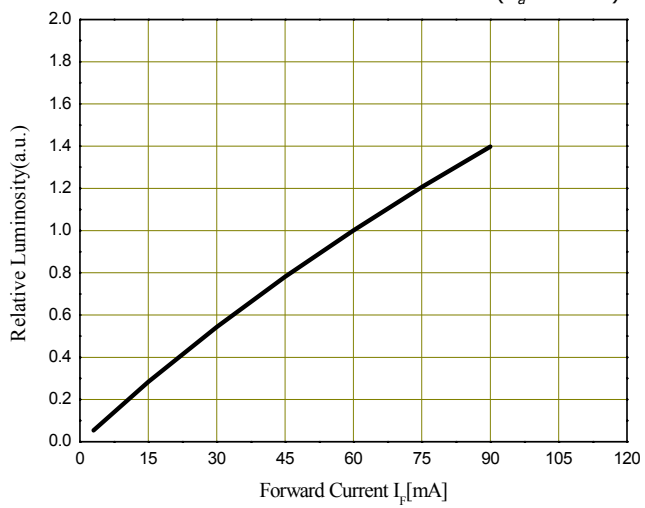

### 4. Optical characteristics

Ambient Temperature vs. Allowable Forward Current (per die)

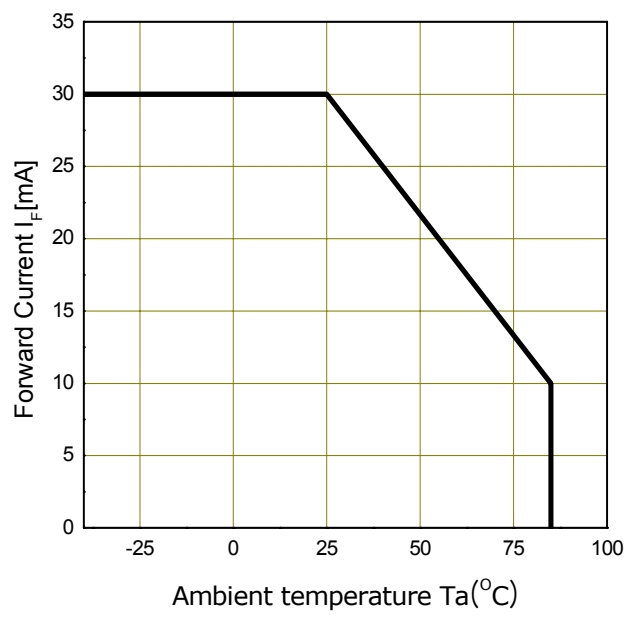

Radiation Diagram

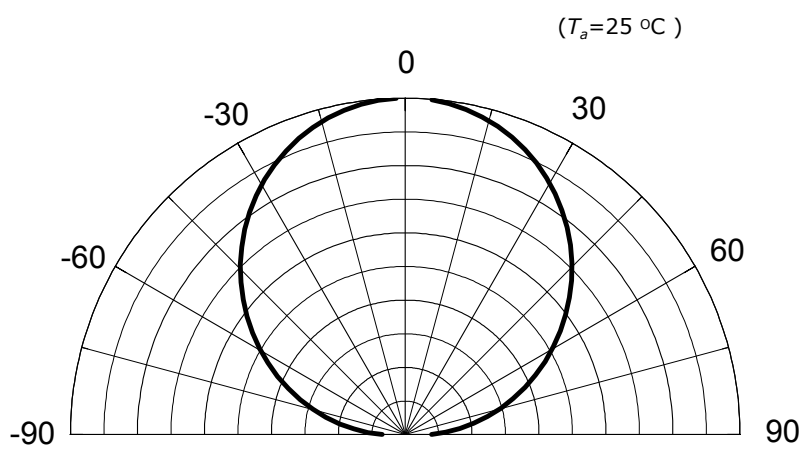

### 4. Optical characteristics

Spectrum

( $T_A=25^{\circ}\text{C}$ ,  $I_F=60\text{mA}$ )

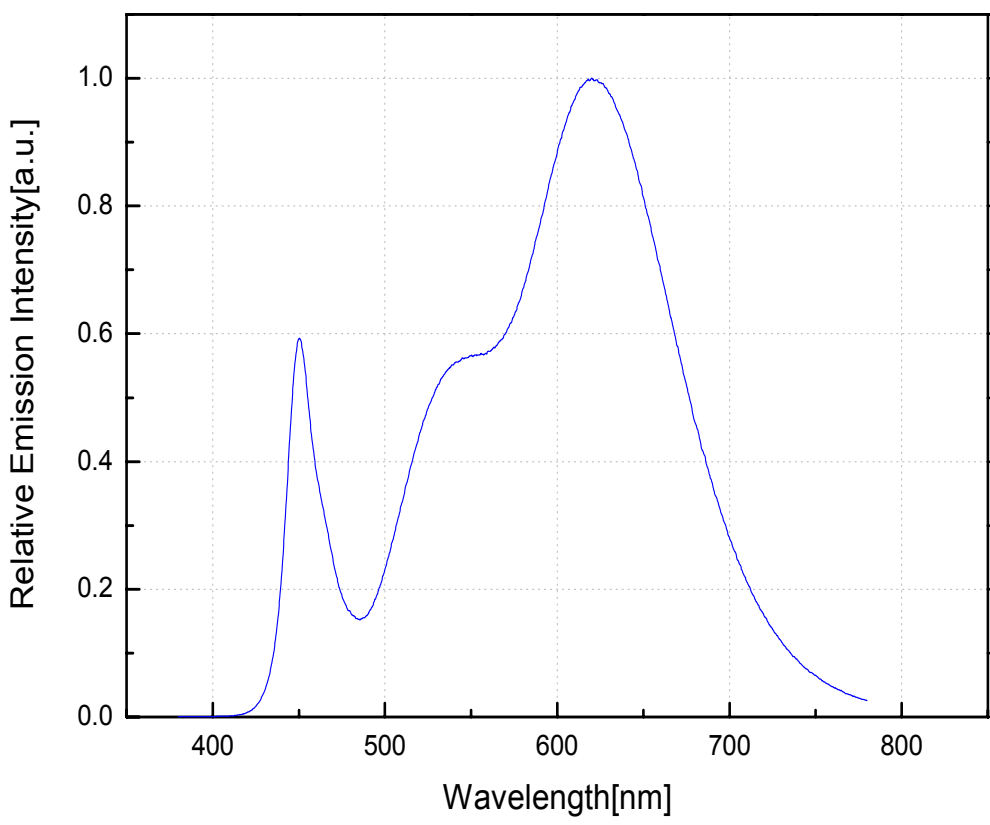

5. Color & Binning

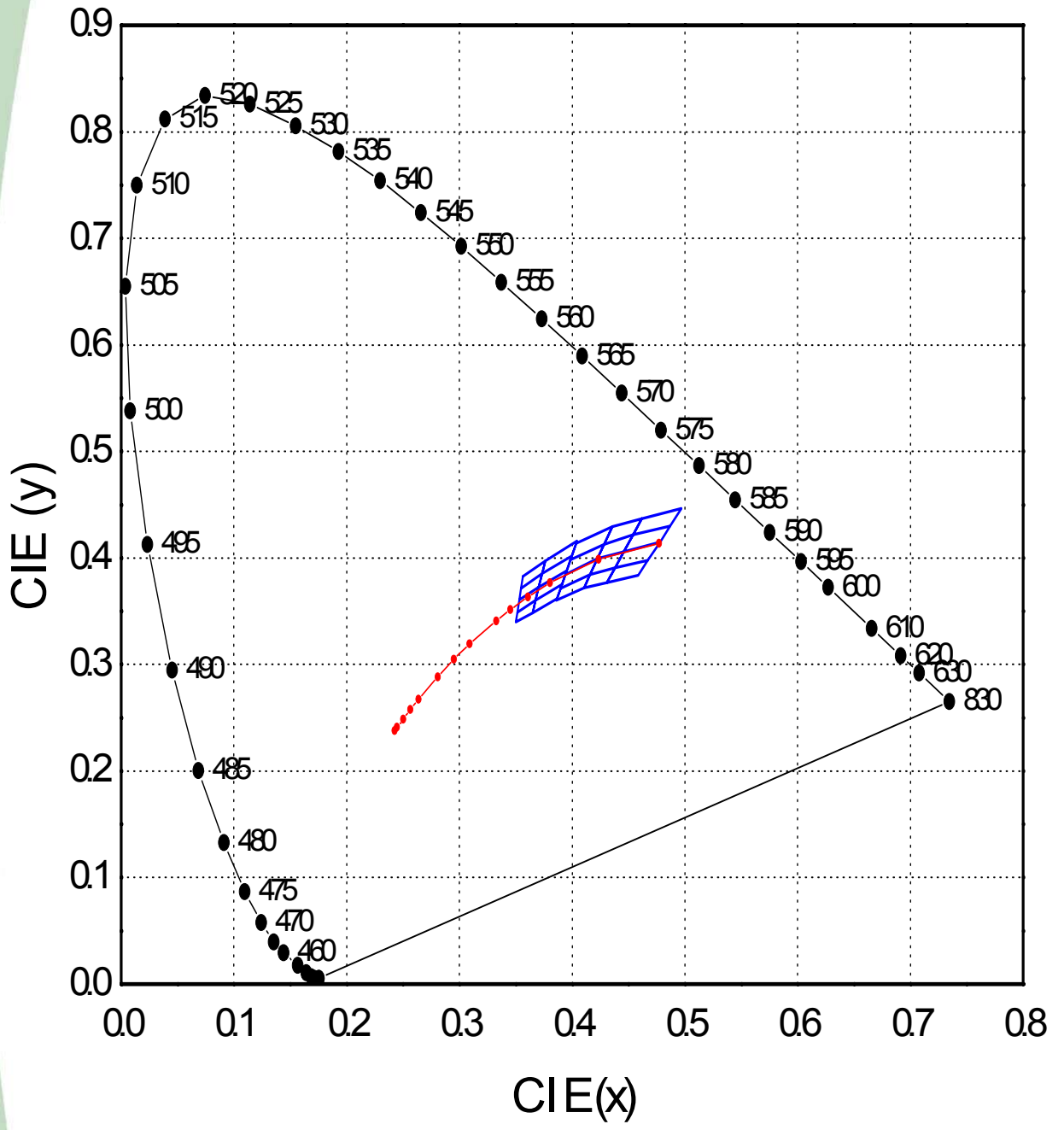



### 5. Color & Binning

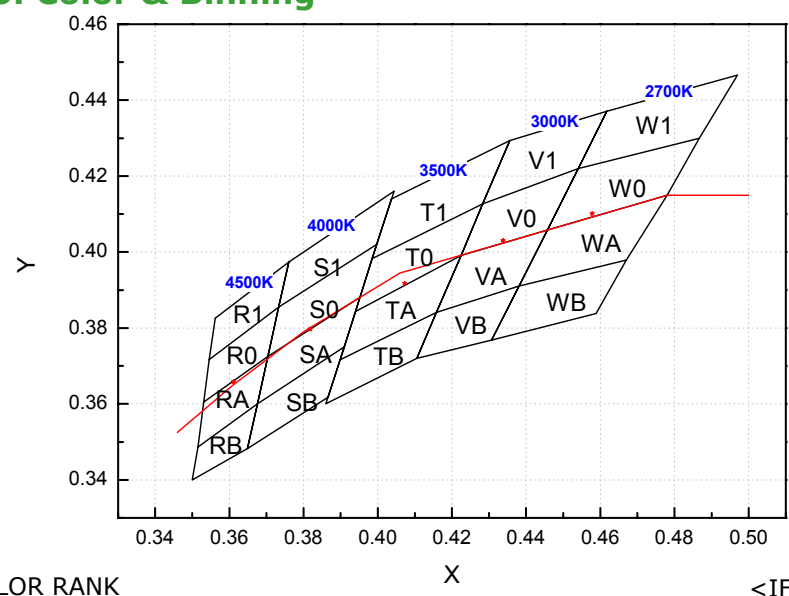

● COLOR RANK

<IF=20mA, Ta=25°C >

4500K							
RB		RA		R0		R1	
X	Y	X	Y	X	Y	X	Y
0.3515	0.3487	0.3531	0.3605	0.3546	0.3717	0.3562	0.3826
0.35	0.34	0.3515	0.3487	0.3531	0.3605	0.3546	0.3717
0.3649	0.3482	0.3676	0.36	0.3704	0.3725	0.3733	0.3855
0.3676	0.36	0.3704	0.3725	0.3733	0.3855	0.376	0.3974
4000K							
SB		SA		S0		S1	
X	Y	X	Y	X	Y	X	Y
0.3676	0.36	0.3704	0.3725	0.3733	0.3855	0.376	0.3974
0.3649	0.3482	0.3676	0.36	0.3704	0.3725	0.3733	0.3855
0.3866	0.3618	0.391	0.375	0.3952	0.3881	0.3997	0.402
0.391	0.375	0.3952	0.3881	0.3997	0.402	0.4044	0.416
3500K							
TB		TA		T0		T1	
X	Y	X	Y	X	Y	X	Y
0.3898	0.3716	0.394	0.3843	0.3985	0.3983	0.4037	0.414
0.386	0.36	0.3898	0.3716	0.394	0.3843	0.3985	0.3983
0.4106	0.372	0.4158	0.3841	0.4225	0.3991	0.4283	0.4127
0.4158	0.3841	0.4225	0.3991	0.4283	0.4127	0.4356	0.4294
3000K							
VB		VA		V0		V1	
X	Y	X	Y	X	Y	X	Y
0.4158	0.3841	0.4225	0.3991	0.4283	0.4127	0.4356	0.4294
0.4106	0.372	0.4158	0.3841	0.4225	0.3991	0.4283	0.4127
0.4307	0.3768	0.4381	0.391	0.4457	0.4058	0.4541	0.422
0.4381	0.391	0.4457	0.4058	0.4541	0.422	0.4617	0.4371
2700K							
WB		WA		W0		W1	
X	Y	X	Y	X	Y	X	Y
0.4381	0.391	0.4457	0.4058	0.4541	0.422	0.4617	0.4371
0.4307	0.3768	0.4381	0.391	0.4457	0.4058	0.4541	0.422
0.4588	0.3838	0.467	0.3979	0.478	0.415	0.4867	0.43
0.467	0.3979	0.478	0.415	0.4867	0.43	0.497	0.4466

\* Measurement Uncertainty of the Color Coordinates : ± 0.01  
 \*The single bin is not acceptable in the same group of CCT.  
 (At least, 2 bins required to take when ordering)

### 5. Color & Binning

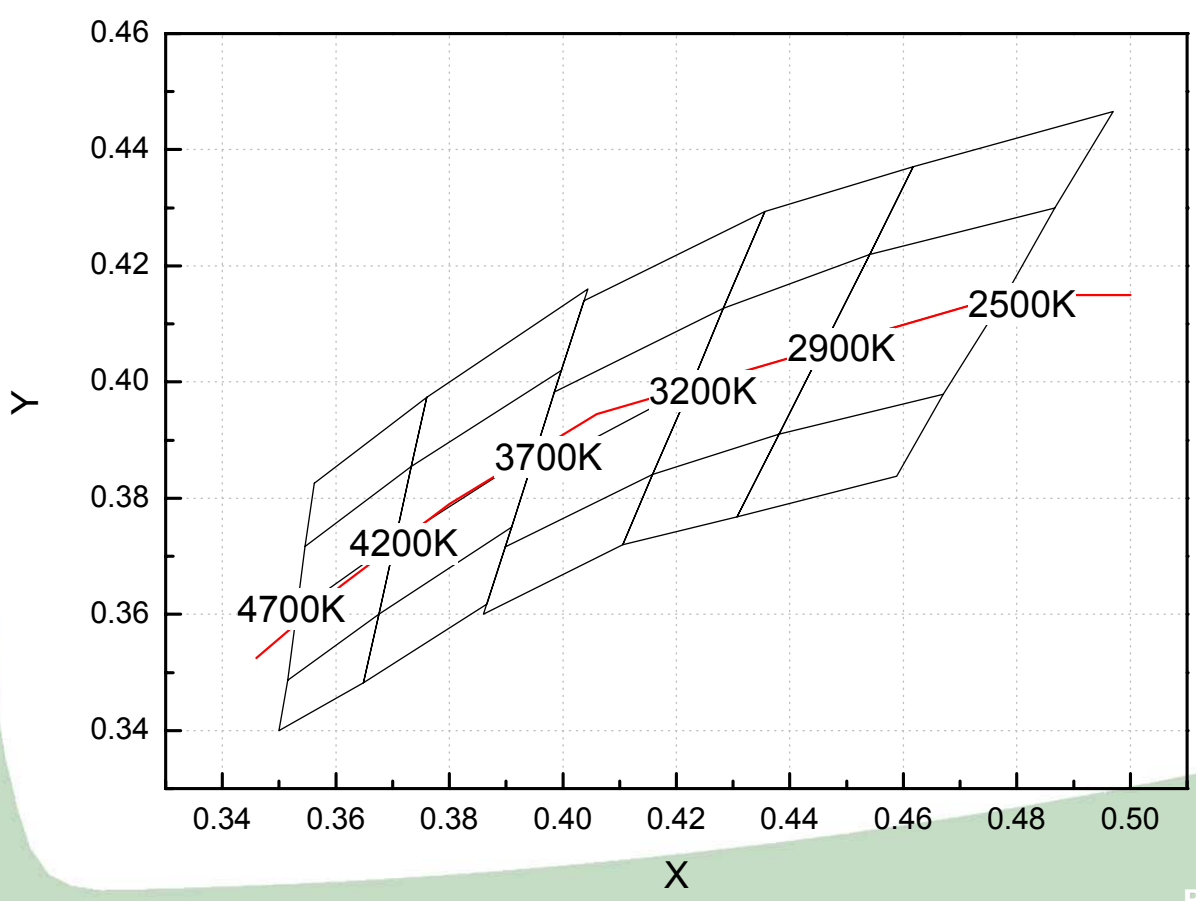
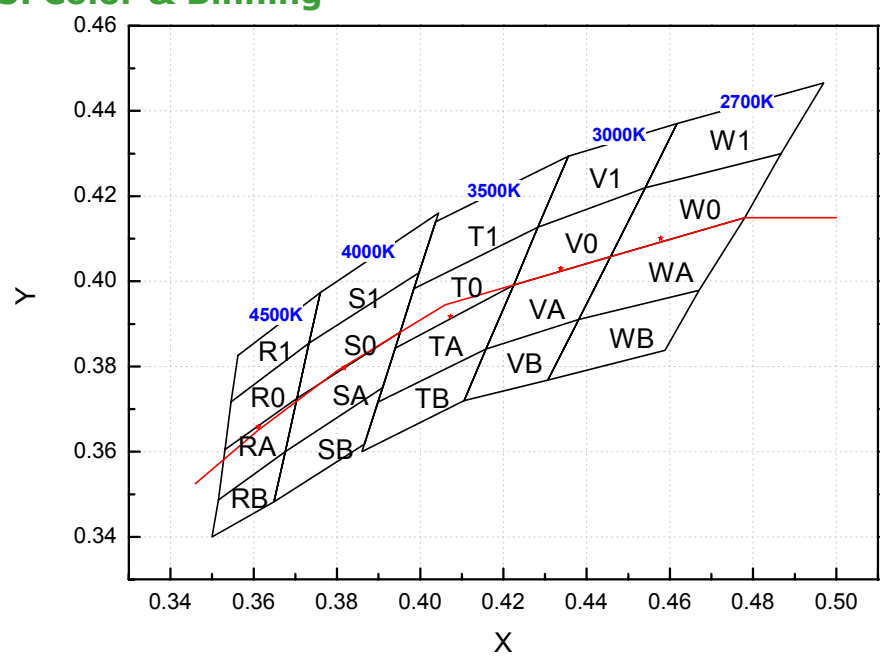

## 6. Rank of CAWT722-S

Rank Name Table

$X_1$	$X_2$	$X_3$
IV	CIE	VF

Intensity value[mcd]

Rank Name	Color : R,S	
	MIN	MAX
L8	3800	4500
M5	4500	5500
N5	5500	6800

Rank Name	Color : T, V, W	
	MIN	MAX
L5	3500	4200
M2	4200	5100
N1	5100	6300

CIE (Color Rank)

Rank Name				
4500K	4000K	3500K	3000K	2700K
R1	S1	T1	V1	W1
R0	S0	T0	V0	W0
RA	SA	TA	VA	WA
RB	SB	TB	VB	WB

Forward Voltage[V]

Rank Name	MIN	MAX
Y3	2.9	3.0
Z1	3.0	3.1
Z2	3.1	3.2
Z3	3.2	3.3
A1	3.3	3.4
A2	3.4	3.5
A3	3.5	3.6

Available Rank

[Note] All measurements were made under the standardized environment of SSC.  
 In order to ensure availability, single color rank will not be orderable.

### 7. Outline Dimension

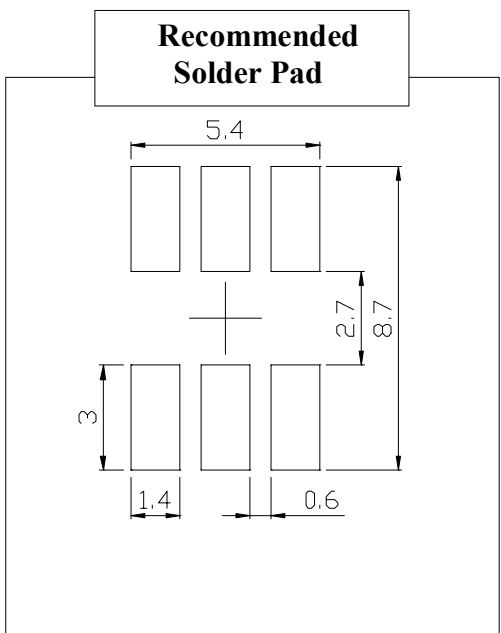
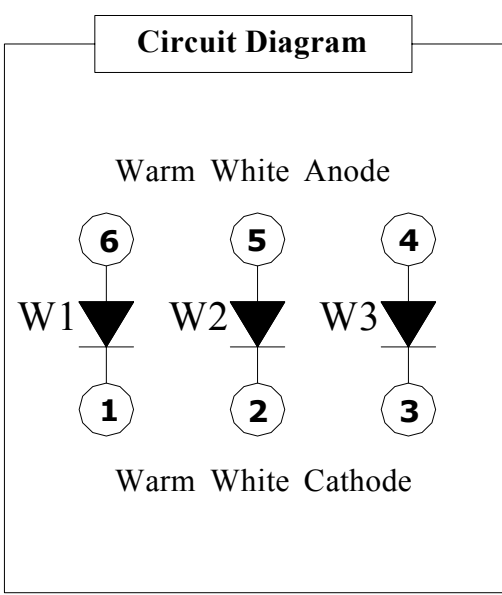
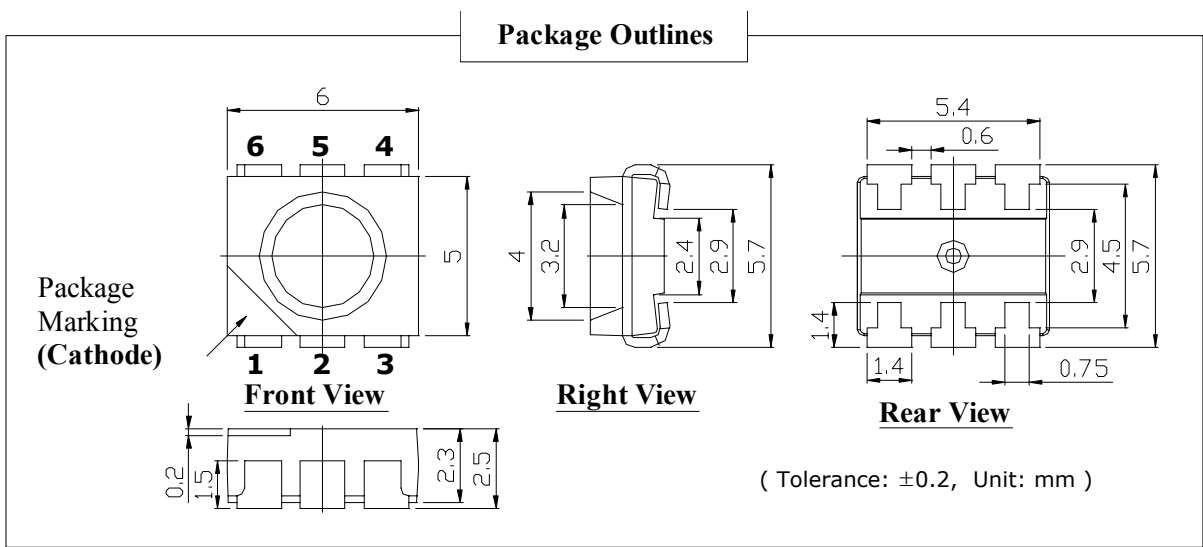

**\* MATERIALS**

PARTS	MATERIALS
Package	Heat-Resistant Polymer
Encapsulating Resin	Silicon Resin
Electrodes	Ag Plating Copper Alloy



● Reel Packing Structure

Reel

RANK: XXXX  
 QUANTITY: XXXX  
 LOT NUMBER: XXXXXXXXXXXX  
 PART NUMBER: XXXXXXXX  
 SEOUL SEMICONDUCTOR CO., LTD.

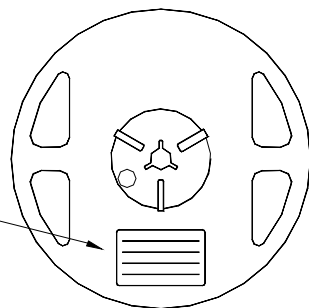

Aluminum Vinyl Bag

RANK: XXXX  
 QUANTITY: XXXX  
 LOT NUMBER: XXXXXXXXXXXX  
 PART NUMBER: XXXXXXXX  
 SEOUL SEMICONDUCTOR CO., LTD.

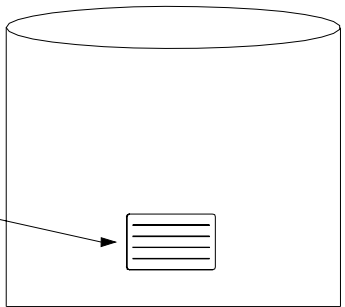

Outer Box Structure

Material : Paper(SW3B(B))

TYPE	SIZE (mm)		
	Ⓐ	Ⓑ	Ⓒ
7inch	245	220	102
	245	220	142

① SIDE

RANK: XXXX  
 QUANTITY: XXXX  
 LOT NUMBER: XXXXXXXXXXXX  
 PART NUMBER: XXXXXXXX  
 SEOUL SEMICONDUCTOR CO., LTD.

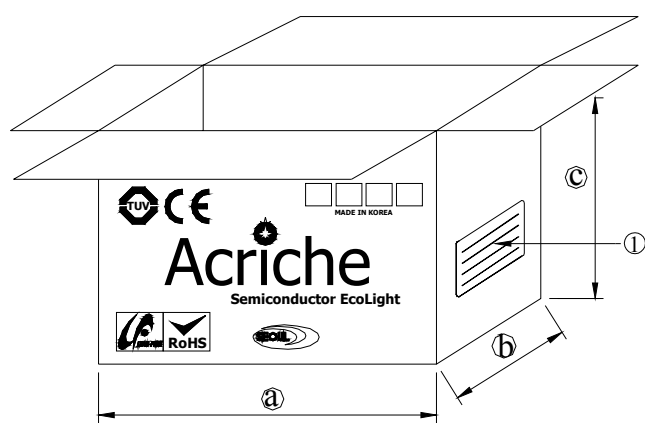

## 9. Soldering

### (1) Lead Solder

Lead Solder	
Pre-heat	120~150°C
Pre-heat time	120 sec. Max.
Peak-Temperature	240°C Max.
Soldering time Condition	10 sec. Max.

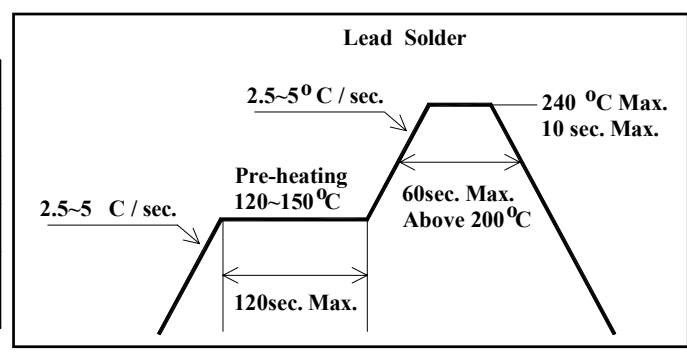

### (2) Lead-Free Solder

Lead Free Solder	
Pre-heat	150~200°C
Pre-heat time	120 sec. Max.
Peak-Temperature	260°C Max.
Soldering time Condition	10 sec. Max.

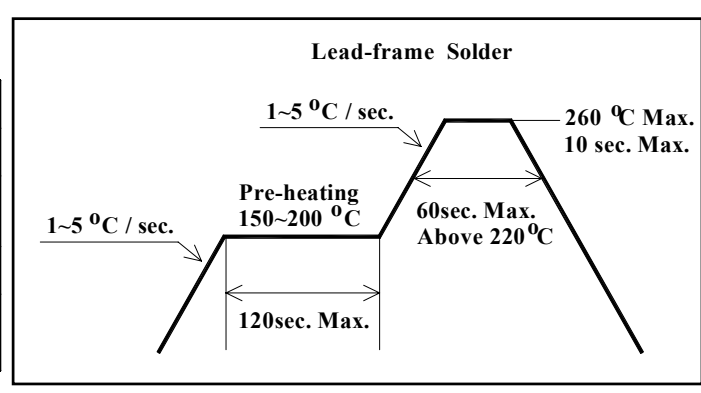

### (3) Hand Soldering conditions

Do not exceed 4 seconds at maximum 315°C under soldering iron.

### (4) The encapsulated material of the LEDs is silicone.

Precautions should be taken to avoid the strong pressure on the encapsulated part.

So when using the chip mounter, the picking up nozzle that does not affect the silicone resin should be used.

Note : In case that the soldered products are reused in soldering process, we don't guarantee the products.

## 10. Precaution for use

### (1) Storage

In order to avoid the absorption of moisture, it is recommended to store in a dry box (or a desiccator) with a desiccant. Otherwise, to store them in the following environment is recommended.

Temperature : 5°C ~30°C Humidity : maximum 65%RH

### (2) Attention after open.

LED is correspond to SMD, when LED be soldered dip, interfacial separation may affect the light transmission efficiency, causing the light intensity to drop. Attention in followed;

a. After opened and mounted the soldering shall be quickly.

b. Keeping of a fraction

Temperature : 5 ~ 40°C Humidity : less than 30%

(3) In the case of more than 1 week passed after opening or change color of indicator on desiccant, components shall be dried 10-12hr. at 60±5°C.

(4) Any mechanical force or any excess vibration shall not be accepted to apply during cooling process to normal temperature after soldering.

(5) Quick cooling shall be avoided.

(6) Components shall not be mounted on warped direction of PCB.

(7) Anti radioactive ray design is not considered for the products.

(8) This device should not be used in any type of fluid such as water, oil, organic solvent etc. When washing is required, IPA should be used.

(9) When the LEDs are illuminating, operating current should be decided after considering the ambient maximum temperature.

(10) LEDs must be stored to maintain a clean atmosphere. If the LEDs are stored for 3 months or more after being shipped from SSC, a sealed container with a nitrogen atmosphere should be used for storage.

(11) The LEDs must be soldered within seven days after opening the moisture-proof packing.

(12) Repack unused products with anti-moisture packing, fold to close any opening and then store in a dry place.

(13) The appearance and specifications of the product may be modified for improvement without notice.



## 11. Handling of Silicone Resin LEDs

(1) During processing, mechanical stress on the surface should be minimized as much as possible. Sharp objects of all types should not be used to pierce the sealing compound.



(2) In general, LEDs should only be handled from the side. By the way, this also applies to LEDs without a silicone sealant, since the surface can also become scratched.

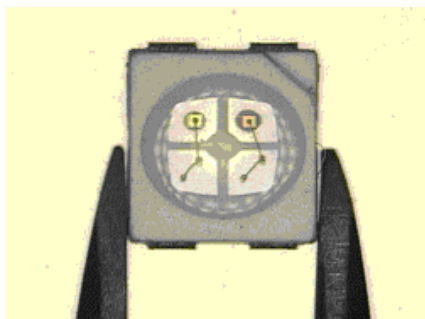

(3) When populating boards in SMT production, there are basically no restrictions regarding the form of the pick and place nozzle, except that mechanical pressure on the surface of the resin must be prevented. This is assured by choosing a pick and place nozzle which is larger than the LED's reflector area.

(4) Silicone differs from materials conventionally used for the manufacturing of LEDs. These conditions must be considered during the handling of such devices. Compared to standard encapsulants, silicone is generally softer, and the surface is more likely to attract dust.

As mentioned previously, the increased sensitivity to dust requires special care during processing. In cases where a minimal level of dirt and dust particles cannot be guaranteed, a suitable cleaning solution must be applied to the surface after the soldering of components.

(5) SSC suggests using isopropyl alcohol for cleaning. In case other solvents are used, it must be assured that these solvents do not dissolve the package or resin. Ultrasonic cleaning is not recommended. Ultrasonic cleaning may cause damage to the LED.

## 12. Reliability Test Item and Condition

Item	Reference	Test Condition	Duration / Cycle	Number of Damage
Thermal Shock	EIAJ ED-4701	$T_a = -40^{\circ}\text{C}$ (30MIN) ~ $100^{\circ}\text{C}$ (30MIN)	100 Cycle	0/22
Temperature Cycle	EIAJ ED-4701	$T_a = -40^{\circ}\text{C}$ (30MIN) ~ $25^{\circ}\text{C}$ (5MIN) ~ $100^{\circ}\text{C}$ (30MIN) ~ $25^{\circ}\text{C}$ (5MIN)	100 Cycle	0/22
High Temperature Storage	EIAJ ED-4701	$T_a = 100^{\circ}\text{C}$	1000 Hours	0/22
High Temperature High Humidity Storage	EIAJ ED-4701	$T_a = 85^{\circ}\text{C}$ , RH=85%	1000 Hours	0/22
Low Temperature Storage	EIAJ ED-4701	$T_a = -40^{\circ}\text{C}$	1000 Hours	0/22
Operating Endurance Test	Internal Reference	$T_a = 25^{\circ}\text{C}$ , $I_F = 20\text{mA}$	1000 Hours	0/22
High Temperature High Humidity Life Test	Internal Reference	$T_a = 85^{\circ}\text{C}$ , RH=85%, $I_F = 15\text{mA}$	300 Hours	0/22
High Temperature Life Test	Internal Reference	$T_a = 85^{\circ}\text{C}$ , $I_F = 20\text{mA}$	500 Hours	0/22
Low Temperature Life Test	Internal Reference	$T_a = -40^{\circ}\text{C}$ , $I_F = 20\text{mA}$	1000 Hours	0/22
ESD(HBM)	MIL-STD-883D	1KV at 1.5k $\Omega$ ; 100pF	3 Time	0/22

### □ Criteria for Judging the Damage

Item	Symbol	Condition	Criteria for Judgement	
			MIN	MAX
Forward Voltage	$V_F$	$I_F = 20\text{mA}$	-	USL*1 $\times$ 1.2
Reverse Current	$I_R$	$V_R = 5\text{V}$	-	USL*1 $\times$ 2.0
Luminous Intensity	$I_V$	$I_F = 20\text{mA}$	LSL*2 $\times$ 0.5	-

Note : \*1 USL : Upper Standard Level  
 \*2 LSL : Lower Standard Level