



Features

- ◇ For IF SAW filter
- ◇ High attenuation
- ◇ Single-ended operation
- ◇ Dual In-line Package
- ◇ RoHS compliant (2002/95/EC), Pb-free

Specifications

Parameter	Unit	Minimum	Typical	Maximum
Center Frequency	MHz	190.85	191	191.15
Insertion Loss	dB	-	23.5	30
1.5 dB Bandwidth	MHz	16.4	16.45	-
3 dB Bandwidth	MHz	16.5	16.75	-
40 dB Bandwidth	MHz	-	18.27	18.5
Passband Variation	dB	-	0.9	1.5
Absolute Delay	usec	-	2.43	3
Ultimate Rejection	dB	40	55	-
Material Temperature coefficient	KHz/°C	-3.44		
Substrate Material	-	112LT		
Ambient Temperature	°C	25		
Operating Temperature Range	°C	-40	-	+85
Storage Temperature Range	°C	-45	-	+105
DC Voltage	V	0		
Input Power	dBm	-	-	10
ESD Class	-	1A		
Package Size	DIP2212 (22.2x12.8x4.7mm3)			

Notes:

1. All specifications are based on the test circuit shown;
2. In production, all specifications are measured by Agilent Network analyzer and full 2 port calibration at room temperature;
3. Electrical margin has been built into the design to account for the variations due to temperature drift and manufacturing tolerances;
4. This is the optimum impedance in order to achieve the performance show.

	SIPAT Co., Ltd. (CETC No.26 Research Institute) #14 Nanping Huayuan Road, Chongqing, China, 400060	Part Number	LBT19102	
		Rev. Date	2008-06-04	
		Ver.	1.0	Page

Matching Configuration

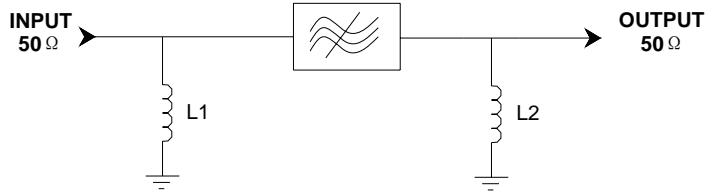

L1=18nH L2=15nH
Source/Load Impedance=50 ohm

Notes - Component values may change depending on board layout.

Package Dimension

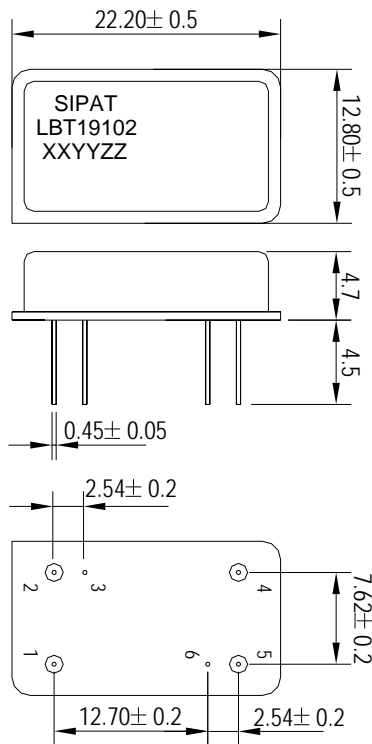

Pad Configuration:

Input 1
Output 5
Ground All Others

Marking Configuration:

- 1) SIPAT: Manufacturer Name
- 2) LBT19102: Part Number
- 3) XXYY: Date(Year/month)
- 4) ZZ: Identified Code

Package: DIP2212

Unit: mm



SIPAT Co., Ltd.
(CETC No.26 Research Institute)
#14 Nanping Huayuan Road,
Chongqing, China, 400060

Part Number	LBT19102	
Rev. Date	2008-06-04	
Ver.	1.0	Page 2/3



Typical Performance

Frequency Respond

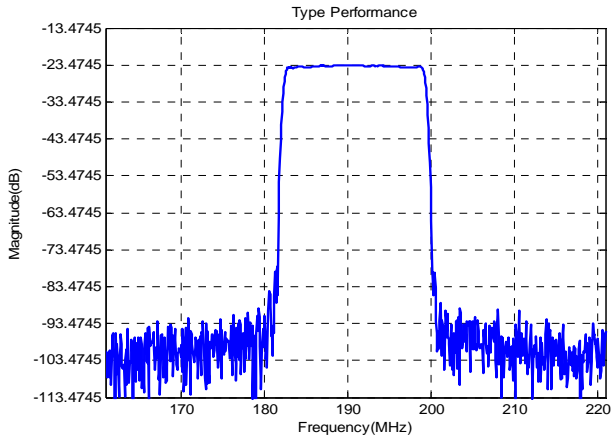

Horizontal: 10MHz/Div Vertical: 10dB/Div

Passband Respond



Horizontal: 5MHz/Div Vertical: 0.5dB/Div

Group Delay Variation($f_0 \pm 8\text{MHz}$)

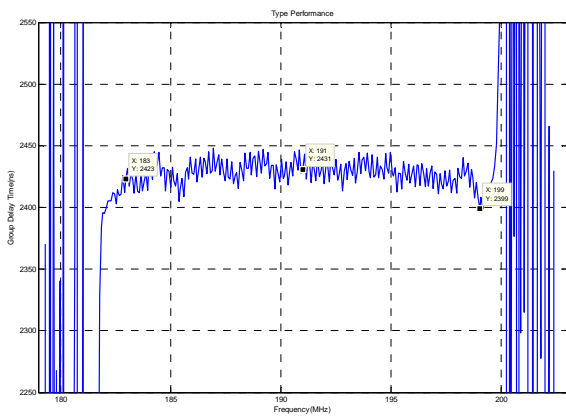

Horizontal: 5MHz/Div Vertical: 50ns/Div

Phase Linearity($f_0 \pm 8\text{MHz}$)

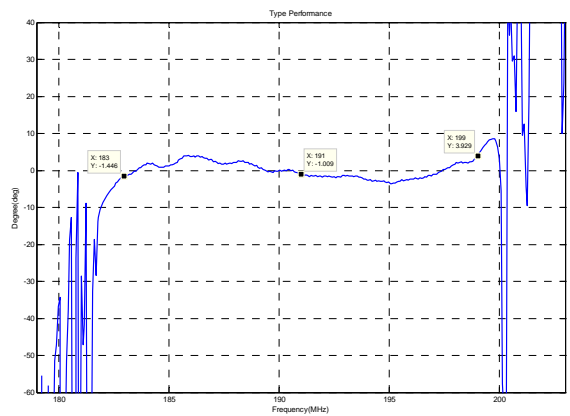

Horizontal: 5MHz/Div Vertical: 10deg/Div

Smith Chart S11

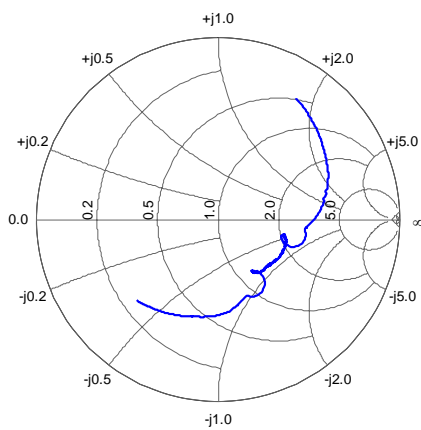

Smith Chart S22

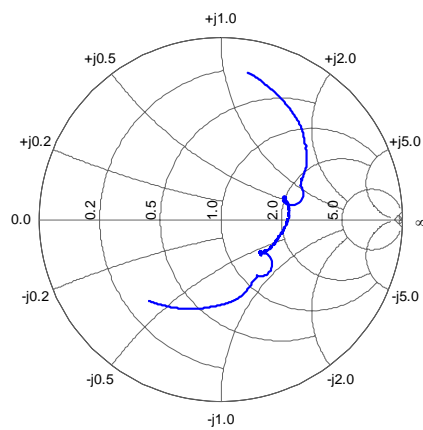

SIPAT Co., Ltd.
(CETC No.26 Research Institute)
#14 Nanping Huayuan Road,
Chongqing, China, 400060

Part Number	LBT19102	
Rev. Date	2008-06-04	
Ver.	1.0	Page 3/3