

January 29, 1998

TEL:805-498-2111 FAX:805-498-3804 WEB:http://www.semtech.com

HIGH CURRENT, HIGH DENSITY, ISOLATED, SILICON POWER RECTIFIER DO5 STUD

QUICK REFERENCE DATA

- Low thermal impedance
- Small size and low weight
- High current applications
- Isolated for direct heatsink mounting
- High surge ratings

- $V_R = 150V - 1000V$
- $I_F = 90A$
- $t_{rr} = 30nS - 2\mu S$
- $I_{FSM} \geq 750A$

ABSOLUTE MAXIMUM RATINGS

Device Type	Working Reverse Voltage (V_{RWM})	Average Rectified Current ($I_{F(AV)}$) @ T_{mb}			1 Cycle Surge I_{FSM} $t_p = 8.3mS$		Repetitive Surge (I_{FRM}) @ 25 °C	Operating & Storage Temperature Range (T_{OP}) (T_{STG})
		@ 55°C	100°C	125°C	@ 25 °C	@ 100°C		
		Volts	Amps	Amps	Amps	Amps		
SET100203	1000	90	66	48	750	600	150	-55 to +175
SET100219	1000	60	48	36	750	480	90	-55 to +175
SET100212	600	90	66	48	750	600	150	-55 to +175
SET100204	400	90	66	48	750	600	150	-55 to +175
SET100211	150	90	60	42	870	750	144	-55 to +150

$R_{\theta JMB} = 0.5^{\circ}C/W$ for all varieties, other configurations available see next page for details

MECHANICAL

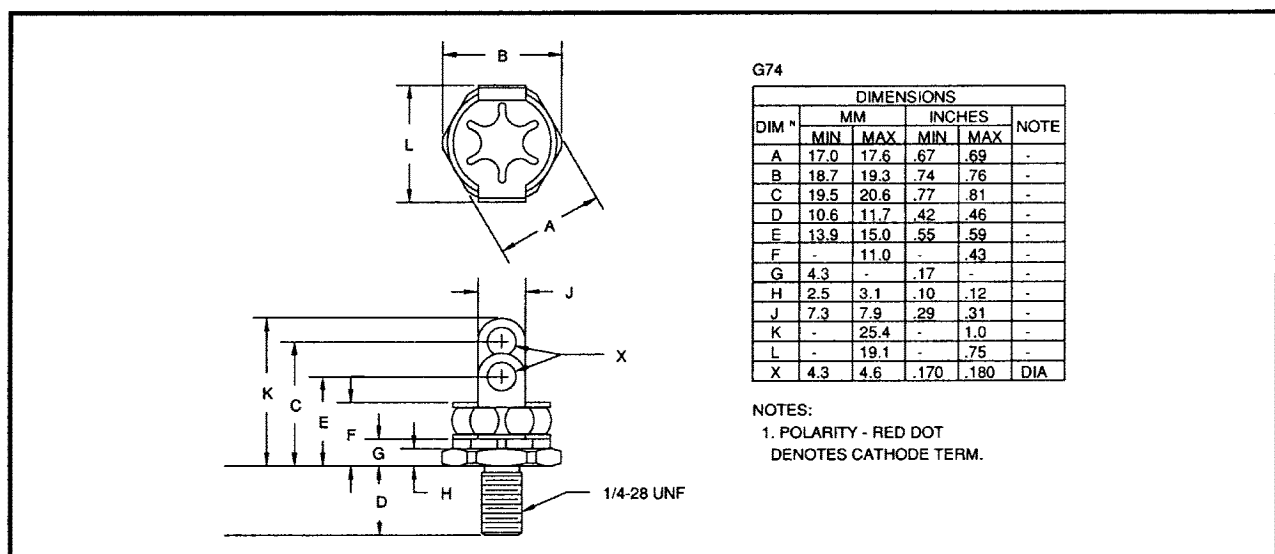

January 29, 1998

ELECTRICAL CHARACTERISTICS

Device Type	Maximum Leakage Current @ V_{RWM}		Maximum Forward Voltage @ 54.0 A	Maximum Reverse Recovery Time
	$T_j = 25\text{ }^\circ\text{C}$	$T_j = 100\text{ }^\circ\text{C}$		
	μA	μA	Volts	nS
SET100203	6.0	120	1.2	2000
SET100219	6.0	150	2.2	150
SET100212	6.0	120	1.2	2000
SET100204	6.0	120	1.5	150
SET100211	60.0	3mA	1.1	30

OTHER CONFIGURATIONS

The Part Numbers Shown in this data Sheet are Isolated with the cathode at the stud end of the device. Part numbers for other configurations are shown below:

Isolated Cathode to Stud	Isolated Anode to Stud	Non-Isolated Cathode to Stud	Non-Isolated Anode to Stud
SET100203	SET100403	SET100103	SET100303
SET100219	SET100419	SET100119	SET100319
SET100212	SET100412	SET100112	SET100312
SET100204	SET100404	SET100104	SET100304
SET100211	SET100411	SET100111	SET100311

January 29, 1998

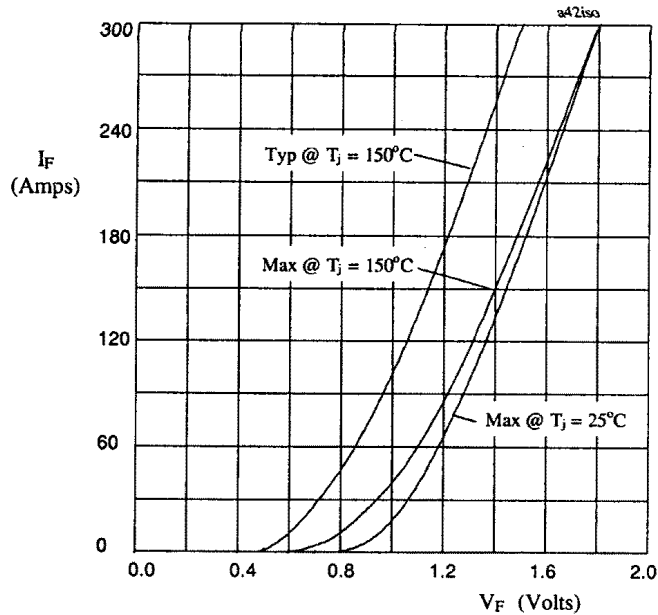

Figure 1. Forward voltage drop as a function of forward current for SET10**03 & SET10**12.

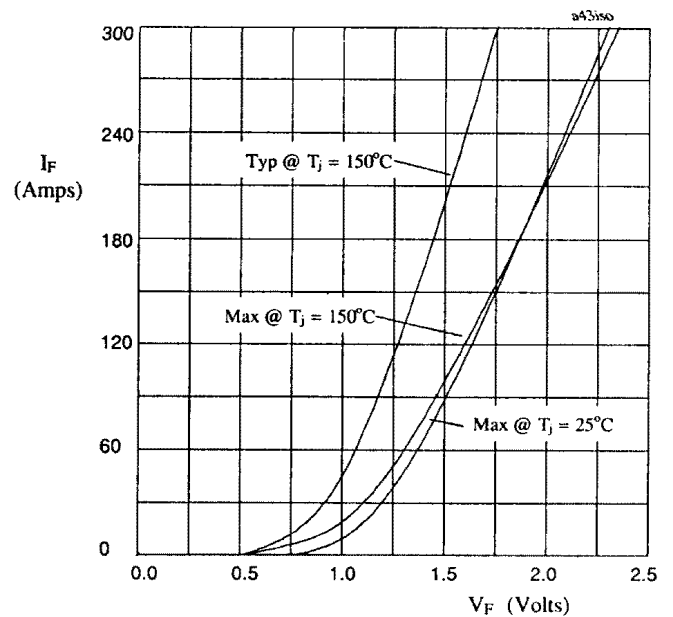

Figure 2. Forward voltage drop as a function of forward current for SET10**04.

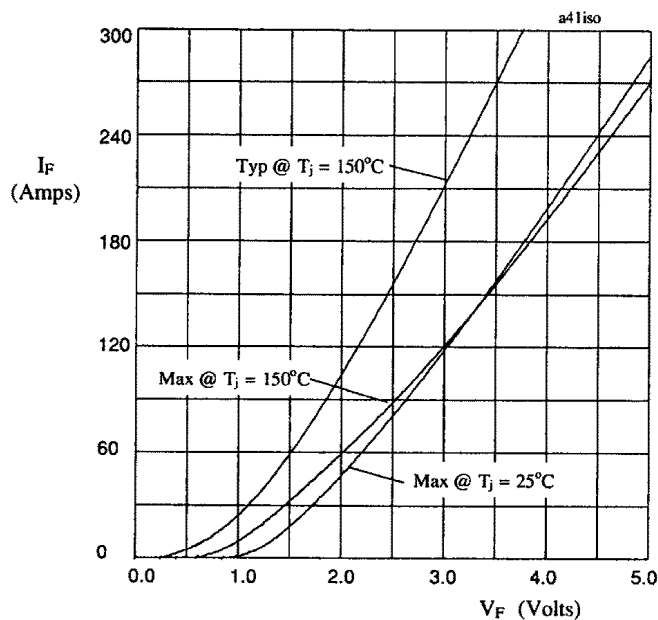

Figure 3. Forward voltage drop as a function of forward current for SET10**19.

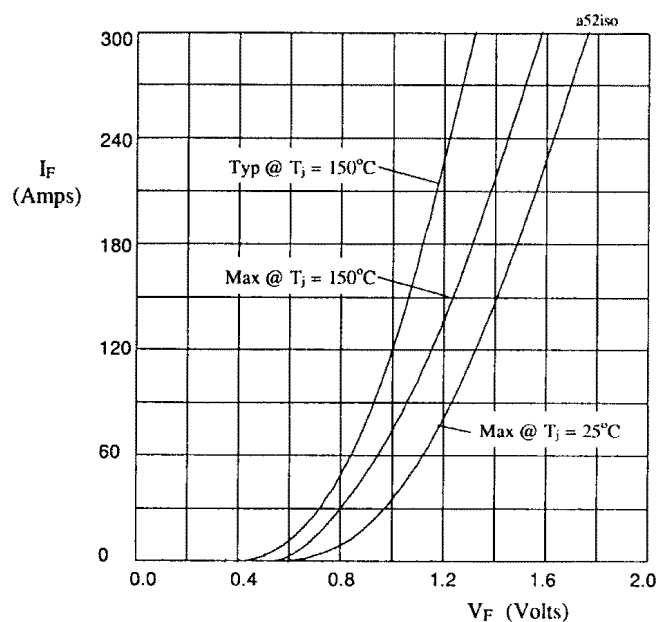

Figure 4. Forward voltage drop as a function of forward current for SET10**11.

January 29, 1998

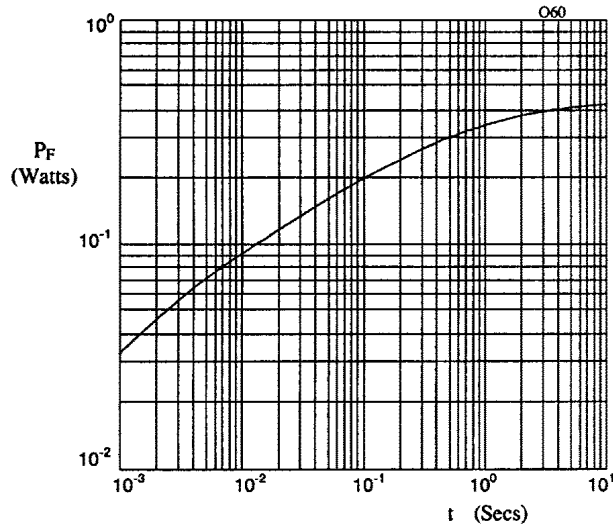

Figure 5. Typical transient thermal impedance characteristic.

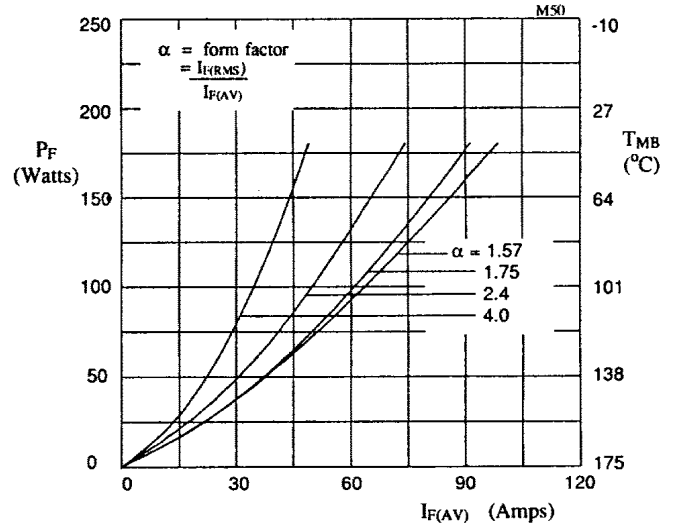

Figure 6. Forward power dissipation and maximum allowable mounting base temperature as a function of forward current for sinusoidal operation, for SET10**03 and SET10**12.

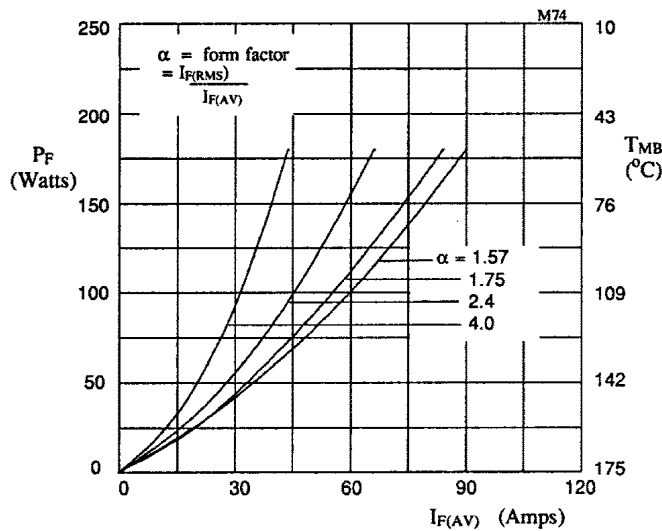

Figure 7. Forward power dissipation and maximum allowable mounting base temperature as a function of forward current for sinusoidal operation, for SET10**04.

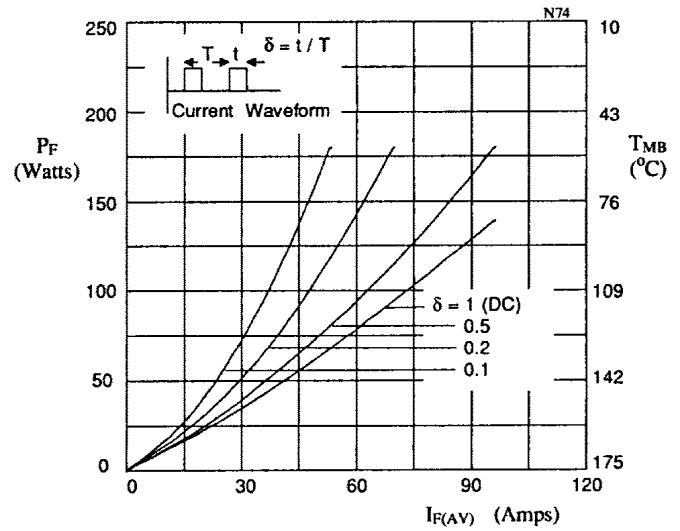

Figure 8. Forward power dissipation and maximum allowable mounting base temperature as a function of forward current for square wave operation, for SET10**04

January 29, 1998

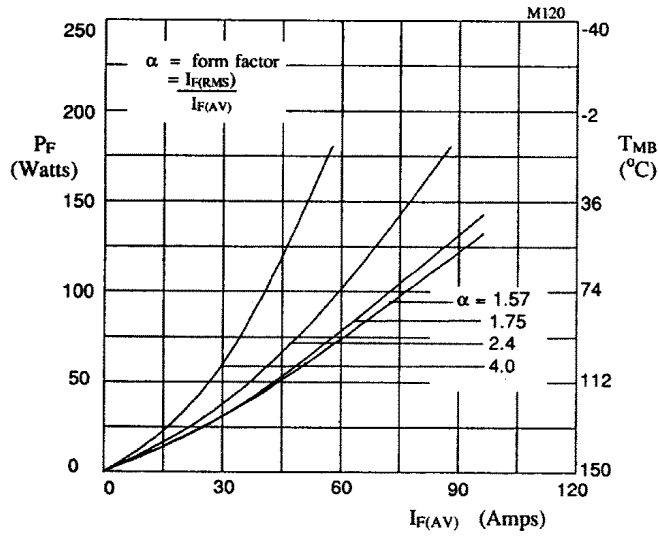

Figure 9. Forward power dissipation and maximum allowable mounting base temperature as a function of forward current for sinusoidal operation, for SET10**11.

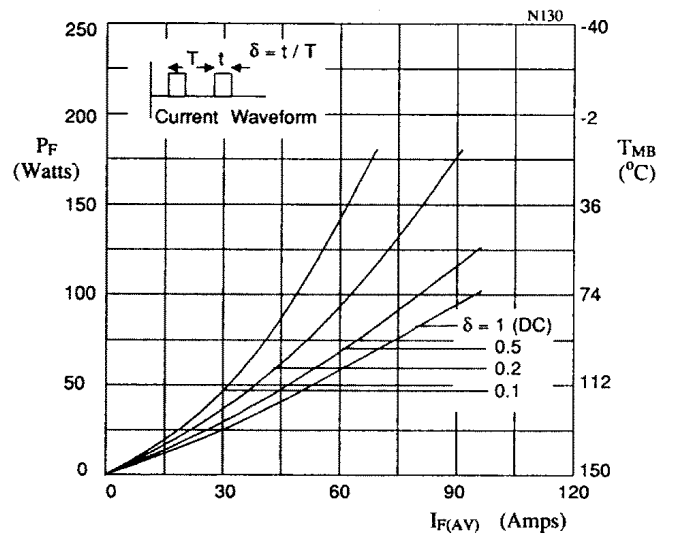

Figure 10. Forward power dissipation and maximum allowable mounting base temperature as a function of forward current for square wave operation, for SET10**11.