

Optocoupler, Phototransistor Output (Dual, Quad Channel)

Dual Channel

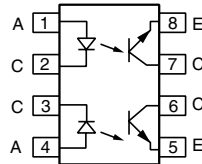

Quad Channel

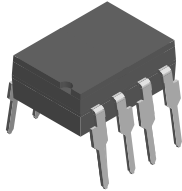
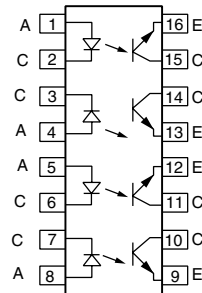
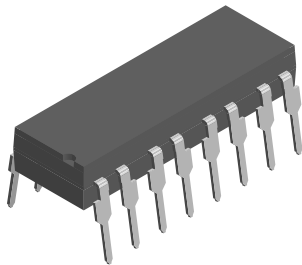

i179012

DESCRIPTION

The ILD1/2/5/ILQ1/2/5 are optically coupled isolated pairs employing GaAs infrared LEDs and silicon NPN phototransistor. Signal information, including a DC level, can be transmitted by the drive while maintaining a high degree of electrical isolation between input and output. The ILD1/2/5/ILQ1/2/5 are especially designed for driving medium-speed logic and can be used to eliminate troublesome ground loop and noise problems. Also these couplers can be used to replace relays and transformers in many digital interface applications such as CTR modulation. The ILD1/2/5 has two isolated channels in a single DIP package and the ILQ1/2/5 has four isolated channels per package..

FEATURES

- Current transfer ratio at $I_F = 10 \text{ mA}$
- Isolation test voltage, $5300 V_{RMS}$
- Lead (Pb)-free component
- Component in accordance to RoHS 2002/95/EC and WEEE 2002/96/EC



RoHS
COMPLIANT

AGENCY APPROVALS

- UL1577, file no. E52744 system code H or J, double protection
- CSA 93751
- BSI IEC 60950 IEC 60065
- DIN EN 60747-5-2 (VDE 0884)/DIN EN 60747-5-5 pending available with option 1
- FIMKO

ORDER INFORMATION

PART	REMARKS
ILD1	CTR > 20 %, DIP-8
ILQ1	CTR > 20 %, DIP-16
ILD2	CTR > 100 %, DIP-8
ILQ2	CTR > 100 %, DIP-16
ILD5	CTR > 50 %, DIP-8
ILQ5	CTR > 50 %, DIP-16
ILD1-X007	CTR > 20 %, SMD-8 (option 7)

ILD1/ILD2/ILD5/ILQ1/ILQ2/ILQ5



Vishay Semiconductors

Optocoupler, Phototransistor Output
(Dual, Quad Channel)

ORDER INFORMATION	
PART	REMARKS
ILD1-X009	CTR > 20 %, SMD-8 (option 9)
ILD2-X006	CTR > 100 %, DIP-8 400 mil (option 6)
ILD2-X007	CTR > 100 %, SMD-8 (option 7)
ILD2-X009	CTR > 100 %, SMD-8 (option 9)
ILD5-X009	CTR > 50 %, SMD-8 (option 9)
ILQ1-X009	CTR > 20 %, SMD-16 (option 9)
ILQ2-X009	CTR > 100 %, SMD-16 (option 9)

Note

For additional information on the available options refer to option information.

ABSOLUTE MAXIMUM RATINGS ⁽¹⁾					
PARAMETER	TEST CONDITION	PART	SYMBOL	VALUE	UNIT
INPUT					
Reverse voltage			V_R	6.0	V
Forward current			I_F	60	mA
Surge current			I_{FSM}	2.5	A
Power dissipation			P_{diss}	100	mW
Derate linearly from 25 °C				1.3	mW/°C
OUTPUT					
Collector emitter reverse voltage		ILD1	V_{CER}	50	V
		ILQ1	V_{CER}	50	V
		ILD2	V_{CER}	70	V
		ILQ2	V_{CER}	70	V
		ILD5	V_{CER}	70	V
		ILQ5	V_{CER}	70	V
Collector current			I_C	50	mA
	$t < 1.0$ ms		I_C	400	mA
Power dissipation			P_{diss}	200	mW
Derate linearly from 25 °C				2.6	mW/°C
COUPLER					
Isolation test voltage (between emitter and detector referred to standard climate 25 °C/50 % RH, DIN 50014)			V_{ISO}	5300	V_{RMS}
Creepage distance				≥ 7.0	mm
Clearance distance				≥ 7.0	mm
Isolation resistance	$V_{IO} = 500$ V, $T_{amb} = 25$ °C		R_{IO}	10^{12}	Ω
	$V_{IO} = 500$ V, $T_{amb} = 100$ °C		R_{IO}	10^{11}	Ω
Package power dissipation			P_{tot}	250	mW
Derate linearly from 25 °C				3.3	mW/°C
Storage temperature			T_{stg}	- 40 to + 150	°C
Operating temperature			T_{amb}	- 40 to + 100	°C
Junction temperature			T_j	100	°C
Soldering temperature ⁽²⁾	2.0 mm from case bottom		T_{sld}	260	°C

Notes

⁽¹⁾ $T_{amb} = 25$ °C, unless otherwise specified.

Stresses in excess of the absolute maximum ratings can cause permanent damage to the device. Functional operation of the device is not implied at these or any other conditions in excess of those given in the operational sections of this document. Exposure to absolute maximum ratings for extended periods of the time can adversely affect reliability.

⁽²⁾ Refer to reflow profile for soldering conditions for surface mounted devices (SMD). Refer to wave profile for soldering conditions for through hole devices (DIP).



ELECTRICAL CHARACTERISTICS						
PARAMETER	TEST CONDITION	SYMBOL	MIN.	TYP.	MAX.	UNIT
INPUT						
Forward voltage	$I_F = 60 \text{ mA}$	V_F		1.25	1.65	V
Reverse current	$V_R = 6.0 \text{ V}$	I_R		0.01	10	μA
Capacitance	$V_R = 0 \text{ V}, f = 1.0 \text{ MHz}$	C_O		25		pF
Thermal resistance, junction to lead		T_{thJL}		750		K/W
OUTPUT						
Collector emitter capacitance	$V_{CE} = 5.0 \text{ V}, f = 1.0 \text{ MHz}$	C_{CE}		6.8		pF
Collector emitter leakage current	$V_{VCE} = 10 \text{ V}$	I_{CEO}		5.0	50	nA
Saturation voltage, collector emitter	$I_C = 1.0 \text{ mA}, I_B = 20 \mu\text{A}$	V_{CESAT}		0.25	0.4	V
DC forward current gain	$V_{CE} = 10 \text{ V}, I_B = 20 \mu\text{A}$	h_{FE}	200	650	1800	
DC forward current gain saturated	$V_{CE} = 0.4 \text{ V}, I_B = 20 \mu\text{A}$	h_{FEsat}	120	400	600	
Thermal resistance, junction to lead		R_{thJl}		500		K/W
COUPLER						
Capacitance (input to output)	$V_{IO} = 0 \text{ V}, f = 1.0 \text{ MHz}$	C_{IO}		0.8		pF

Note

$T_{amb} = 25 \text{ }^\circ\text{C}$, unless otherwise specified.

Minimum and maximum values are testing requirements. Typical values are characteristics of the device and are the result of engineering evaluation. Typical values are for information only and are not part of the testing requirements.

CURRENT TRANSFER RATIO							
PARAMETER	TEST CONDITION	PART	SYMBOL	MIN.	TYP.	MAX.	UNIT
Current transfer ratio (collector emitter saturated)	$I_F = 10 \text{ mA}, V_{CE} = 0.4 \text{ V}$	ILD1	CTR_{CEsat}		75		%
		ILQ1	CTR_{CEsat}		75		%
		ILD2	CTR_{CEsat}		170		%
		ILQ2	CTR_{CEsat}		170		%
		ILD5	CTR_{CEsat}		100		%
		ILQ5	CTR_{CEsat}		100		%
Current transfer ratio (collector emitter)	$I_F = 10 \text{ mA}, V_{CE} = 10 \text{ V}$	ILD1	CTR_{CE}	20	80	300	%
		ILQ1	CTR_{CE}	20	80	300	%
		ILD2	CTR_{CE}	100	200	500	%
		ILQ2	CTR_{CE}	100	200	500	%
		ILD5	CTR_{CE}	50	130	400	%
		ILQ5	CTR_{CE}	50	130	400	%

SWITCHING CHARACTERISTICS							
PARAMETER	TEST CONDITION	PART	SYMBOL	MIN.	TYP.	MAX.	UNIT
NON-SATURATED							
Current	$V_{CE} = 5.0 \text{ V}, R_L = 75 \Omega, 50 \% \text{ of } V_{PP}$	ILD1	I_F		20		mA
		ILQ1	I_F		20		mA
		ILD2	I_F		5.0		mA
		ILQ2	I_F		5.0		mA
		ILD5	I_F		10		mA
		ILQ5	I_F		10		mA

ILD1/ILD2/ILD5/ILQ1/ILQ2/ILQ5



Vishay Semiconductors

Optocoupler, Phototransistor Output
(Dual, Quad Channel)

SWITCHING CHARACTERISTICS							
PARAMETER	TEST CONDITION	PART	SYMBOL	MIN.	TYP.	MAX.	UNIT
NON-SATURATED							
Delay	$V_{CE} = 5.0\text{ V}, R_L = 75\ \Omega, 50\% \text{ of } V_{PP}$	ILD1	t_D		0.8		μs
		ILQ1	t_D		0.8		μs
		ILD2	t_D		1.7		μs
		ILQ2	t_D		1.7		μs
		ILD5	t_D		1.7		μs
		ILQ5	t_D		1.7		μs
Rise time	$V_{CE} = 5.0\text{ V}, R_L = 75\ \Omega, 50\% \text{ of } V_{PP}$	ILD1	t_r		1.9		μs
		ILQ1	t_r		1.9		μs
		ILD2	t_r		2.6		μs
		ILQ2	t_r		2.6		μs
		ILD5	t_r		2.6		μs
		ILQ5	t_r		2.6		μs
Storage	$V_{CE} = 5.0\text{ V}, R_L = 75\ \Omega, 50\% \text{ of } V_{PP}$	ILD1	t_s		0.2		μs
		ILQ1	t_s		0.2		μs
		ILD2	t_s		0.4		μs
		ILQ2	t_s		0.4		μs
		ILD5	t_s		0.4		μs
		ILQ5	t_s		0.4		μs
Fall time	$V_{CE} = 5.0\text{ V}, R_L = 75\ \Omega, 50\% \text{ of } V_{PP}$	ILD1	t_f		1.4		μs
		ILQ1	t_f		1.4		μs
		ILD2	t_f		2.2		μs
		ILQ2	t_f		2.2		μs
		ILD5	t_f		2.2		μs
		ILQ5	t_f		2.2		μs
Propagation H to L	$V_{CE} = 5.0\text{ V}, R_L = 75\ \Omega, 50\% \text{ of } V_{PP}$	ILD1	t_{PHL}		0.7		μs
		ILQ1	t_{PHL}		0.7		μs
		ILD2	t_{PHL}		1.2		μs
		ILQ2	t_{PHL}		1.2		μs
		ILD5	t_{PHL}		1.1		μs
		ILQ5	t_{PHL}		1.1		μs
Propagation L to H	$V_{CE} = 5.0\text{ V}, R_L = 75\ \Omega, 50\% \text{ of } V_{PP}$	ILD1	t_{PLH}		1.4		μs
		ILQ1	t_{PLH}		1.4		μs
		ILD2	t_{PLH}		2.3		μs
		ILQ2	t_{PLH}		2.3		μs
		ILD5	t_{PLH}		2.5		μs
		ILQ5	t_{PLH}		2.5		μs
SATURATED							
Current	$V_{CE} = 0.4\text{ V}, R_L = 1.0\text{ k}\Omega, V_{CC} = 5.0\text{ V}, V_{TH} = 1.5\text{ V}$	ILD1	I_F		20		mA
		ILQ1	I_F		20		mA
		ILD2	I_F		5.0		mA
		ILQ2	I_F		5.0		mA
		ILD5	I_F		10		mA
		ILQ5	I_F		10		mA
Delay	$V_{CE} = 0.4\text{ V}, R_L = 1.0\text{ k}\Omega, V_{CC} = 5.0\text{ V}, V_{TH} = 1.5\text{ V}$	ILD1	t_D		0.8		μs
		ILQ1	t_D		0.8		μs
		ILD2	t_D		1.0		μs
		ILQ2	t_D		1.0		μs
		ILD5	t_D		1.7		μs
		ILQ5	t_D		1.7		μs



SWITCHING CHARACTERISTICS							
PARAMETER	TEST CONDITION	PART	SYMBOL	MIN.	TYP.	MAX.	UNIT
SATURATED							
Rise time	$V_{CE} = 0.4\text{ V}$, $R_L = 1.0\text{ k}\Omega$, $V_{CC} = 5.0\text{ V}$, $V_{TH} = 1.5\text{ V}$	ILD1	t_r		1.2		μs
		ILQ1	t_r		1.2		μs
		ILD2	t_r		2.0		μs
		ILQ2	t_r		2.0		μs
		ILD5	t_r		7.0		μs
		ILQ5	t_r		7.0		μs
Storage	$V_{CE} = 0.4\text{ V}$, $R_L = 1.0\text{ k}\Omega$, $V_{CC} = 5.0\text{ V}$, $V_{TH} = 1.5\text{ V}$	ILD1	t_s		7.4		μs
		ILQ1	t_s		7.4		μs
		ILD2	t_s		5.4		μs
		ILQ2	t_s		5.4		μs
		ILD5	t_s		4.6		μs
		ILQ5	t_s		4.6		μs
Fall time	$V_{CE} = 0.4\text{ V}$, $R_L = 1.0\text{ k}\Omega$, $V_{CC} = 5.0\text{ V}$, $V_{TH} = 1.5\text{ V}$	ILD1	t_f		7.6		μs
		ILQ1	t_f		7.6		μs
		ILD2	t_f		13.5		μs
		ILQ2	t_f		13.5		μs
		ILD5	t_f		20		μs
		ILQ5	t_f		20		μs
Propagation H to L	$V_{CE} = 0.4\text{ V}$, $R_L = 1.0\text{ k}\Omega$, $V_{CC} = 5.0\text{ V}$, $V_{TH} = 1.5\text{ V}$	ILD1	t_{PHL}		1.6		μs
		ILQ1	t_{PHL}		1.6		μs
		ILD2	t_{PHL}		5.4		μs
		ILQ2	t_{PHL}		5.4		μs
		ILD5	t_{PHL}		2.6		μs
		ILQ5	t_{PHL}		2.6		μs
Propagation L to H	$V_{CE} = 0.4\text{ V}$, $R_L = 1.0\text{ k}\Omega$, $V_{CC} = 5.0\text{ V}$, $V_{TH} = 1.5\text{ V}$	ILD1	t_{PLH}		8.6		μs
		ILQ1	t_{PLH}		8.6		μs
		ILD2	t_{PLH}		7.4		μs
		ILQ2	t_{PLH}		7.4		μs
		ILD5	t_{PLH}		7.2		μs
		ILQ5	t_{PLH}		7.2		μs

COMMON MODE TRANSIENT IMMUNITY						
PARAMETER	TEST CONDITION	SYMBOL	MIN.	TYP.	MAX.	UNIT
Common mode rejection, output high	$V_{CM} = 50\text{ V}_{P-P}$, $R_L = 1.0\text{ k}\Omega$, $I_F = 0\text{ mA}$	CM_H		5000		$\text{V}/\mu\text{s}$
Common mode rejection, output low	$V_{CM} = 50\text{ V}_{P-P}$, $R_L = 1.0\text{ k}\Omega$, $I_F = 10\text{ mA}$	CM_L		5000		$\text{V}/\mu\text{s}$
Common mode coupling capacitance		C_{CM}		0.01		pF

TYPICAL CHARACTERISTICS

$T_{amb} = 25\text{ }^{\circ}\text{C}$, unless otherwise specified

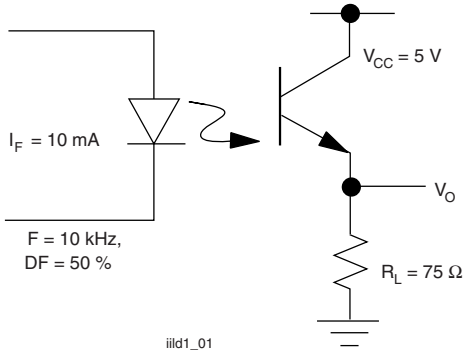

Fig. 1 - Non-Saturated Switching Schematic

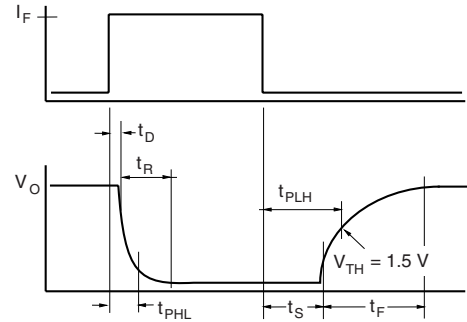

Fig. 4 - Saturated Switching Timing

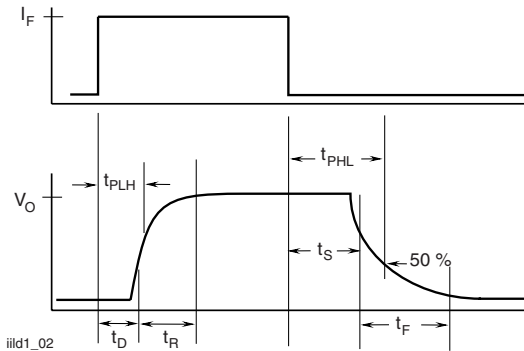

Fig. 2 - Non-Saturated Switching Timing

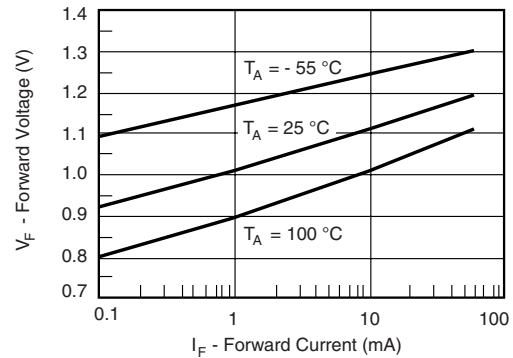

Fig. 5 - Normalized Non-Saturated and Saturated CTR vs. LED Current

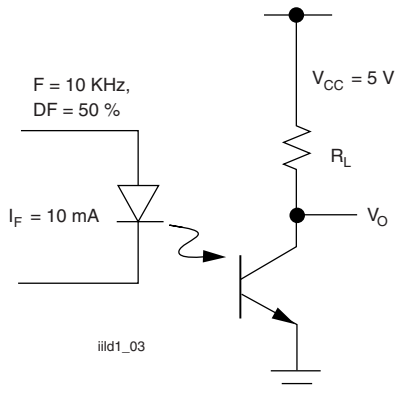

Fig. 3 - Saturated Switching Schematic

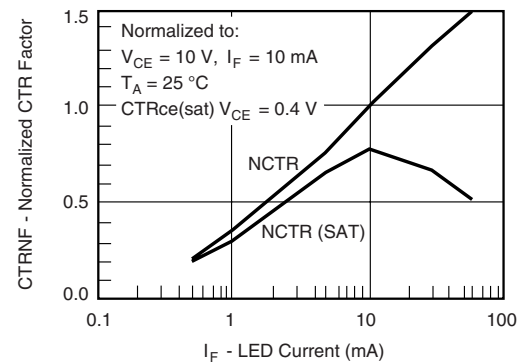
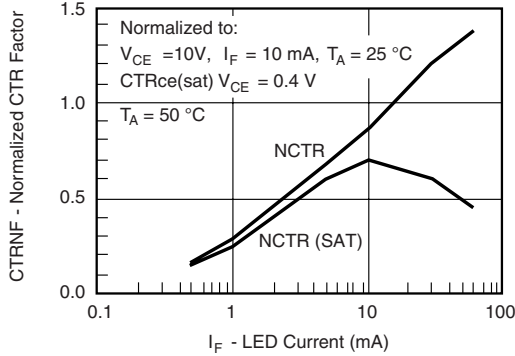
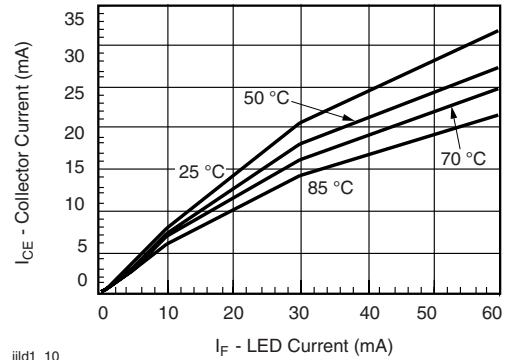

Fig. 6 - Normalized Non-Saturated and Saturated CTR vs. LED Current



iiid1_07

Fig. 7 - Normalized Non-Saturated and Saturated CTR vs. LED Current



iiid1_10

Fig. 10 - Collector Emitter Current vs. Temperature and LED Current

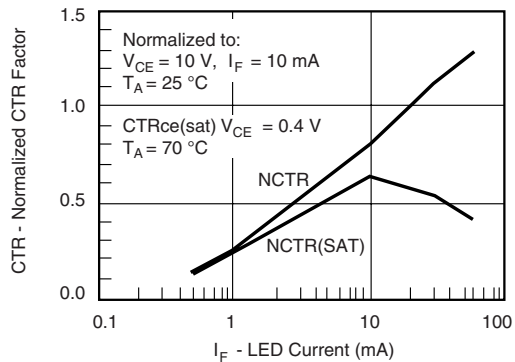

iiid1_08

Fig. 8 - Normalized Non-Saturated and Saturated CTR vs. LED Current

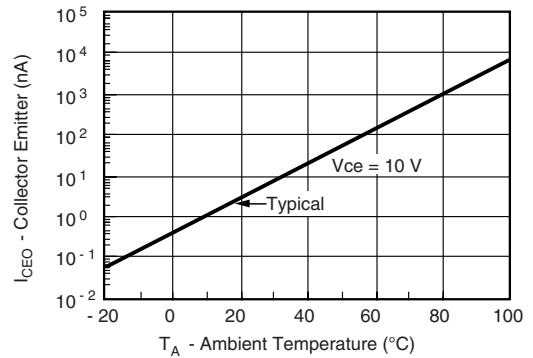

iiid1_11

Fig. 11 - Collector Emitter Leakage Current vs. Temperature

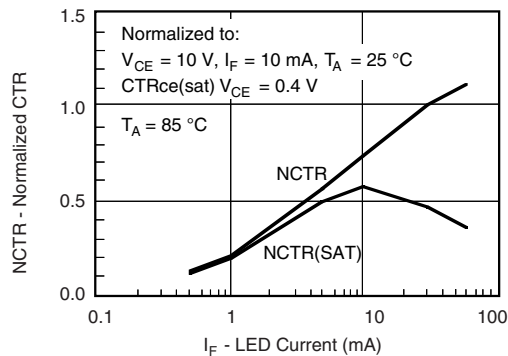

iiid1_09

Fig. 9 - Normalized Non-Saturated and Saturated CTR vs. LED Current

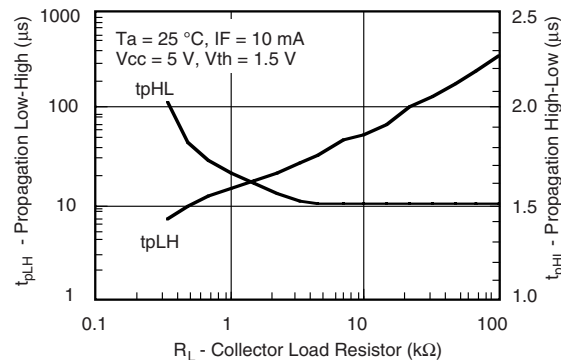

iiid1_12

Fig. 12 - Propagation Delay vs. Collector Load Resistor

ILD1/ILD2/ILD5/ILQ1/ILQ2/ILQ5



Vishay Semiconductors Optocoupler, Phototransistor Output
(Dual, Quad Channel)

PACKAGE DIMENSIONS in inches (millimeters)

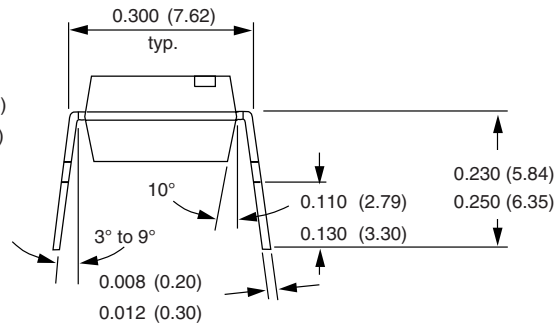
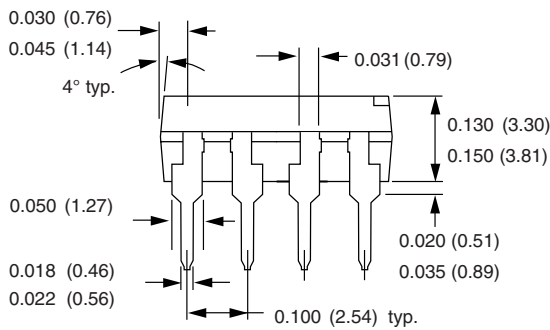
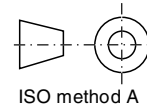
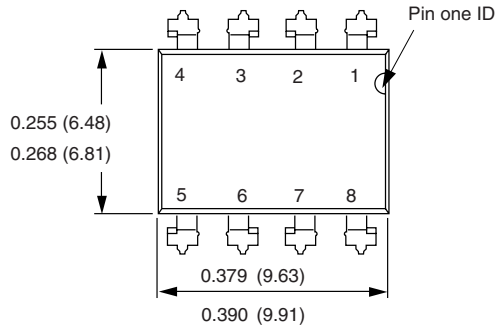

i178006

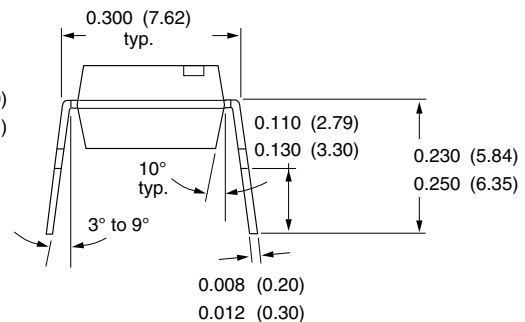
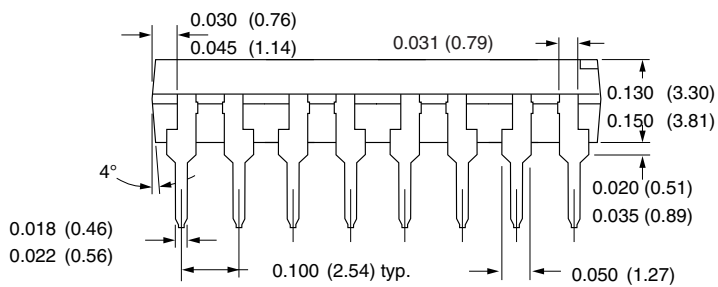
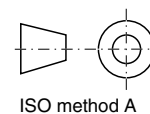
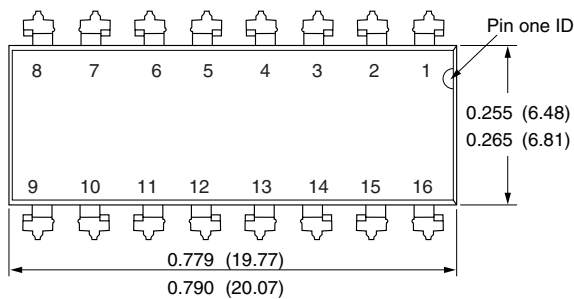

i178007



ILD1/ILD2/ILD5/ILQ1/ILQ2/ILQ5

Optocoupler, Phototransistor Output
(Dual, Quad Channel)

Vishay Semiconductors

Option 6

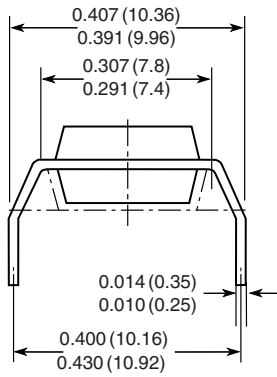

Option 7

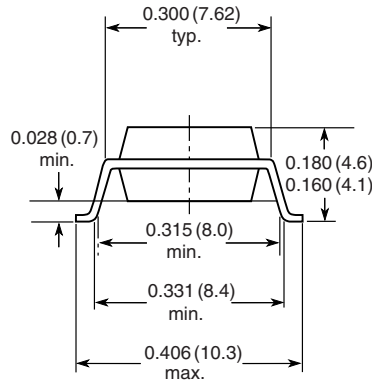

Option 9

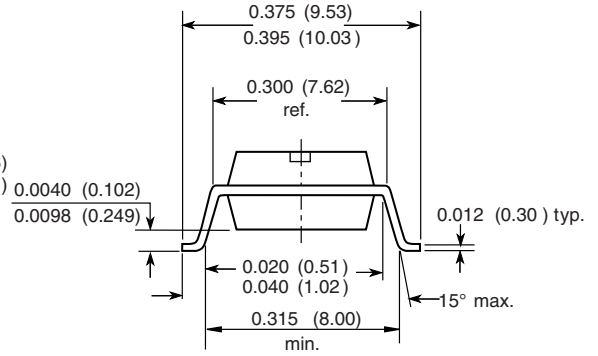

18450

OZONE DEPLETING SUBSTANCES POLICY STATEMENT

It is the policy of Vishay Semiconductor GmbH to

1. Meet all present and future national and international statutory requirements.
2. Regularly and continuously improve the performance of our products, processes, distribution and operating systems with respect to their impact on the health and safety of our employees and the public, as well as their impact on the environment.

It is particular concern to control or eliminate releases of those substances into the atmosphere which are known as ozone depleting substances (ODSs).

The Montreal Protocol (1987) and its London Amendments (1990) intend to severely restrict the use of ODSs and forbid their use within the next ten years. Various national and international initiatives are pressing for an earlier ban on these substances.

Vishay Semiconductor GmbH has been able to use its policy of continuous improvements to eliminate the use of ODSs listed in the following documents.

1. Annex A, B and list of transitional substances of the Montreal Protocol and the London Amendments respectively.
2. Class I and II ozone depleting substances in the Clean Air Act Amendments of 1990 by the Environmental Protection Agency (EPA) in the USA.
3. Council Decision 88/540/EEC and 91/690/EEC Annex A, B and C (transitional substances) respectively.

Vishay Semiconductor GmbH can certify that our semiconductors are not manufactured with ozone depleting substances and do not contain such substances.

We reserve the right to make changes to improve technical design
and may do so without further notice.

Parameters can vary in different applications. All operating parameters must be validated for each customer application by the customer. Should the buyer use Vishay Semiconductors products for any unintended or unauthorized application, the buyer shall indemnify Vishay Semiconductors against all claims, costs, damages, and expenses, arising out of, directly or indirectly, any claim of personal damage, injury or death associated with such unintended or unauthorized use.

Vishay Semiconductor GmbH, P.O.B. 3535, D-74025 Heilbronn, Germany



Disclaimer

All product specifications and data are subject to change without notice.

Vishay Intertechnology, Inc., its affiliates, agents, and employees, and all persons acting on its or their behalf (collectively, "Vishay"), disclaim any and all liability for any errors, inaccuracies or incompleteness contained herein or in any other disclosure relating to any product.

Vishay disclaims any and all liability arising out of the use or application of any product described herein or of any information provided herein to the maximum extent permitted by law. The product specifications do not expand or otherwise modify Vishay's terms and conditions of purchase, including but not limited to the warranty expressed therein, which apply to these products.

No license, express or implied, by estoppel or otherwise, to any intellectual property rights is granted by this document or by any conduct of Vishay.

The products shown herein are not designed for use in medical, life-saving, or life-sustaining applications unless otherwise expressly indicated. Customers using or selling Vishay products not expressly indicated for use in such applications do so entirely at their own risk and agree to fully indemnify Vishay for any damages arising or resulting from such use or sale. Please contact authorized Vishay personnel to obtain written terms and conditions regarding products designed for such applications.

Product names and markings noted herein may be trademarks of their respective owners.