

Silicon NPN Power Transistors

2SC3988

DESCRIPTION

- With TO-3PN package
- High breakdown voltage high reliability.
- Wide area of safe operation
- Fast switching speed

APPLICATIONS

- 500V/25A switching regulator applications

PINNING

PIN	DESCRIPTION
1	Base
2	Collector;connected to mounting base
3	Emitter

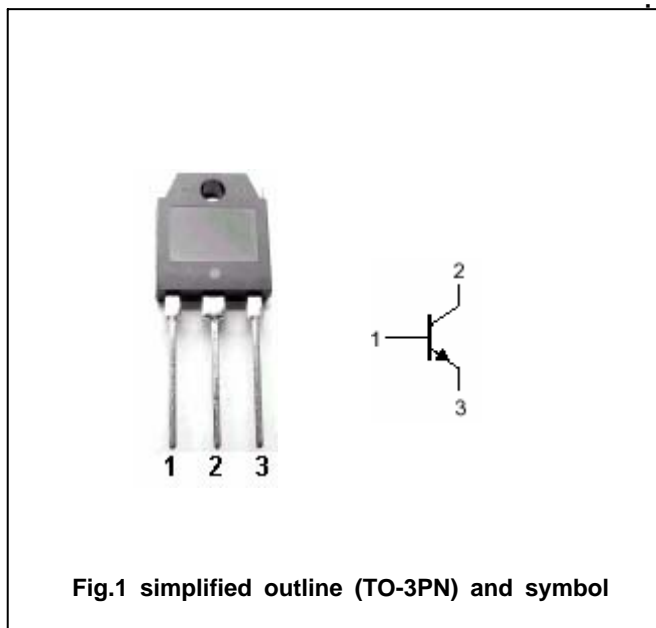

Fig.1 simplified outline (TO-3PN) and symbol

Absolute maximum ratings(Ta=)

SYMBOL	PARAMETER	CONDITIONS	VALUE	UNIT
V _{CBO}	Collector-base voltage	Open emitter	800	V
V _{CEO}	Collector-emitter voltage	Open base	500	V
V _{EBO}	Emitter-base voltage	Open collector	7	V
I _C	Collector current		25	A
I _{CP}	Collector current-peak		40	A
I _B	Base current		8	A
P _C	Collector power dissipation	T _C =25	150	W
T _j	Junction temperature		150	
T _{stg}	Storage temperature		-55~150	

Silicon NPN Power Transistors

2SC3988

CHARACTERISTICS

T_j=25 unless otherwise specified

SYMBOL	PARAMETER	CONDITIONS	MIN	TYP.	MAX	UNIT
V _{(BR)CBO}	Collector-base breakdown voltage	I _C =1mA ; I _E =0	800			V
V _{(BR)CEO}	Collector-emitter breakdown voltage	I _C =5mA ; R _{BE} =	500			V
V _{(BR)EBO}	Emitter-base breakdown voltage	I _C =1mA ; I _C =0	7			V
V _{CEX(SUS)}	Collector-emitter sustaining voltage	I _C =10A ; I _{B1} =-I _{B2} =2A ; L=200 μ H	500			V
V _{CEsat}	Collector-emitter saturation voltage	I _C =12A ; I _B =2.4A			1.0	V
V _{BEsat}	Base-emitter saturation voltage	I _C =12A ; I _B =2.4A			1.5	V
I _{CBO}	Collector cut-off current	V _{CB} =500V ; I _E =0			10	μ A
I _{EBO}	Emitter cut-off current	V _{EB} =5V ; I _C =0			10	μ A
h _{FE-1}	DC current gain	I _C =2.4A ; V _{CE} =5V	15		50	
h _{FE-2}	DC current gain	I _C =12A ; V _{CE} =5V	8			
C _{ob}	Output capacitance	I _E =0 ; V _{CB} =10V ; f=1MHz		260		pF
f _T	Transition frequency	I _C =2.4A ; V _{CE} =10V		18		MHz

Switching times

t _{on}	Turn-on time	5I _{B1} =-2.5I _{B2} = I _C =14A V _{CC} 200V ; R _L =14.3			0.5	μ s
t _{stg}	Storage time				3.0	μ s
t _f	Fall time				0.3	μ s

◆ h_{FE-1} Classifications

L	M	N
15-30	20-40	30-50

Silicon NPN Power Transistors

2SC3988

PACKAGE OUTLINE

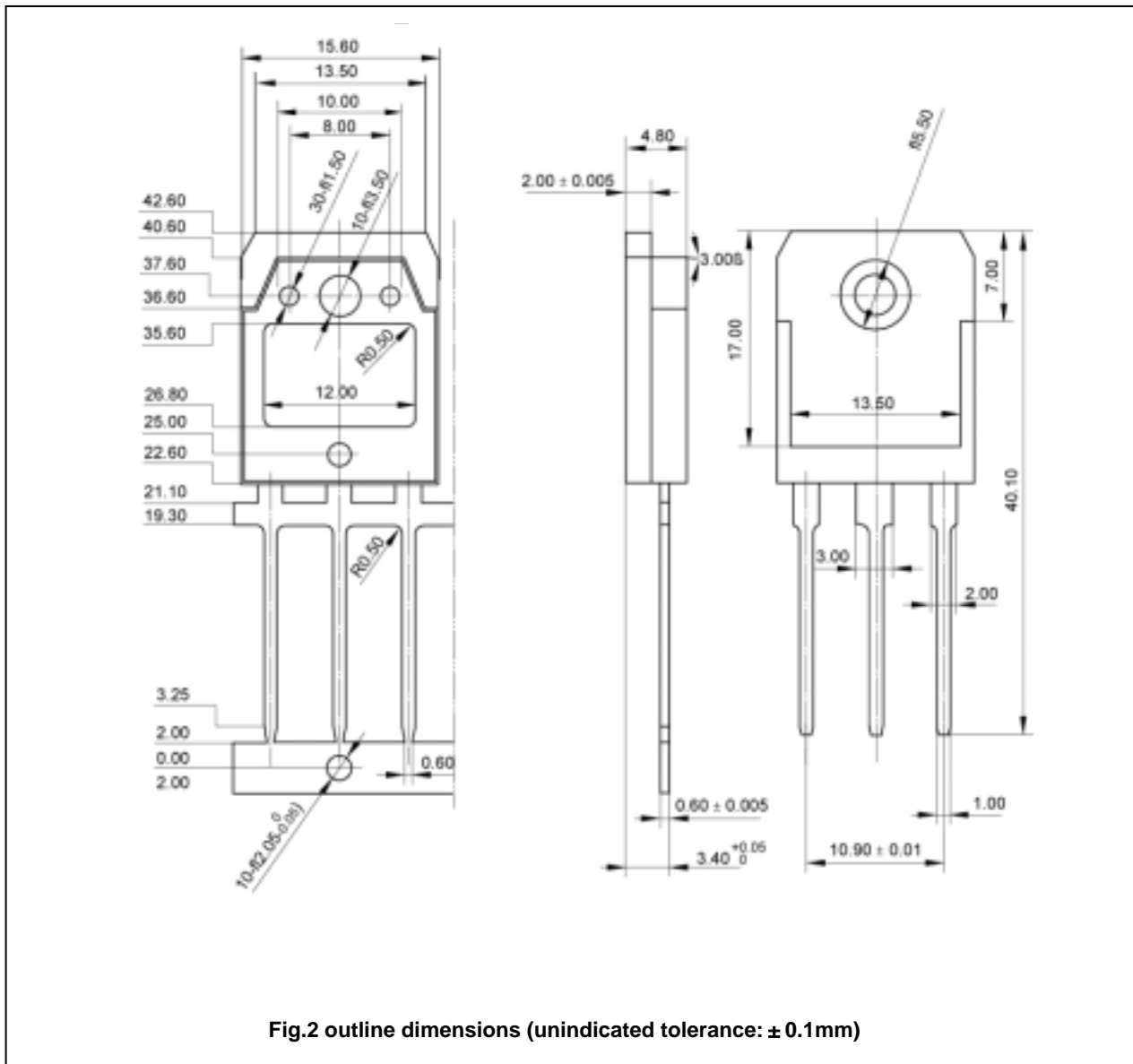

Fig.2 outline dimensions (unindicated tolerance: ± 0.1 mm)

Silicon NPN Power Transistors

2SC3988

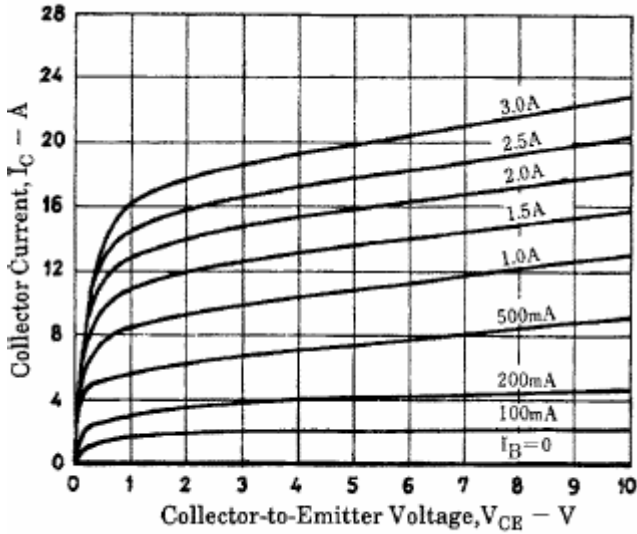

Fig.3 Static Characteristic

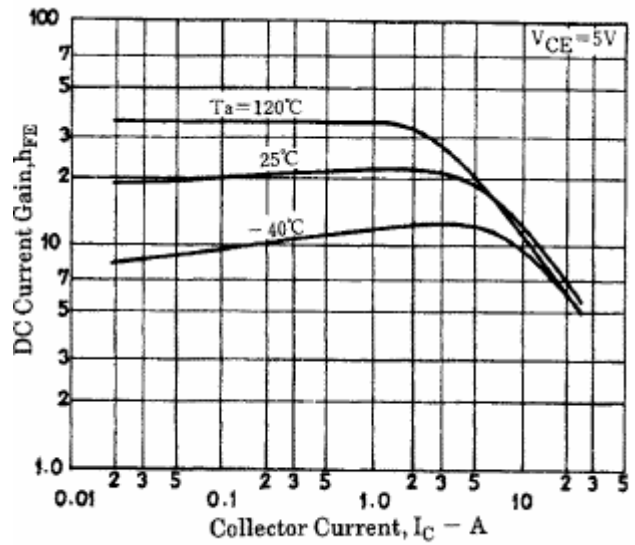

Fig.4 DC current Gain

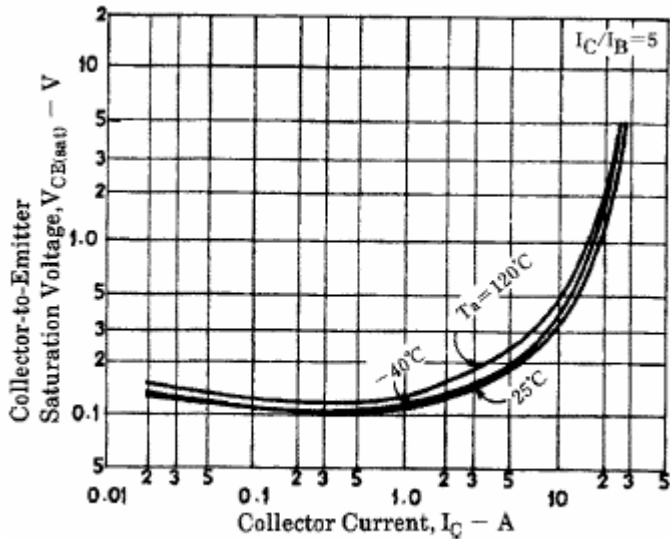

Fig.5 Collector-Emmitter Saturation Voltage

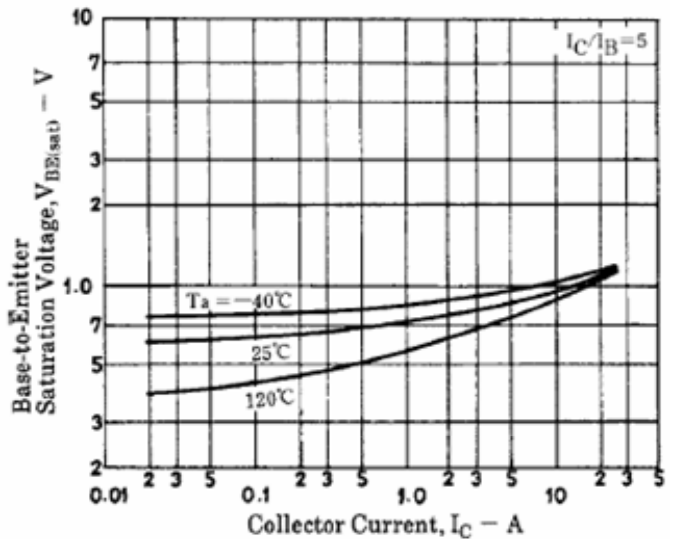

Fig.6 Base-Emmitter Saturation Voltage

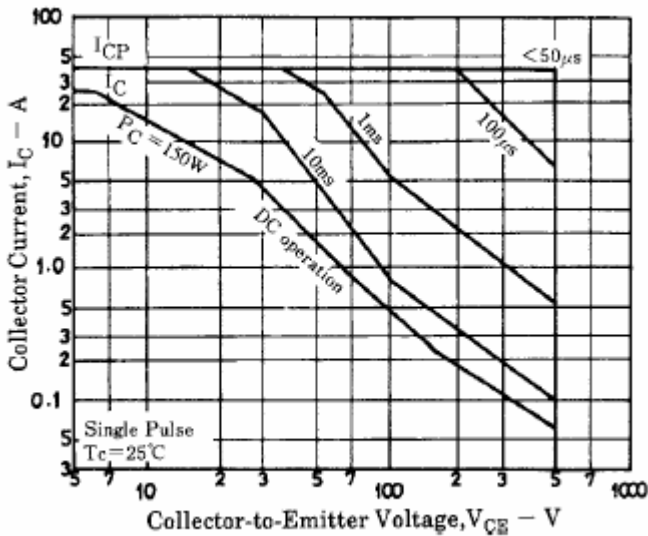

Fig.7 Safe Operating Area