

Interlock Switches

Non contact Switches

Sipha Sensors



Description

With the increasing speed and complexity of applications a simple magnetic switch may be insufficient to meet the increased risks, therefore Sipha's design incorporates several magnetically sensitive elements which must be triggered in a particular sequence to operate correctly. The Sipha sensor, designed to operate with its own actuator, helps prevent defeatability by a simple magnet.

The Sipha with its moulded-in brackets and diminutive size, is extremely versatile and simple to install. The Sipha Sensor must be connected to the Sipha control unit giving a monitored circuit. For high-risk applications the control unit is used with a single sensor to give a high-integrity system. For other applications, multiple sensors (including mechanical switches) can be connected to one Sipha control unit. Sipha has facilities for connecting a manual reset button and for monitoring external devices such as contactors.

Four types of sensors and actuators are available incorporating different operating distances and physical sizes.





Features

- Non contact actuation
- Magnetic coded sensing
- Four housing styles
- Must be operated with its own safety control unit

Specifications

Standards	EN954-1, ISO13849-1, IEC/EN60204-1, NFPA79, EN1088, ISO14119, IEC60947-5-1, IEC/EN60947-5-3, ANSI B11.19, AS4024.1															
Category	Rating dependent on control unit and application.															
Approvals	CE marked for all applicable directives, cULus and TÜV															
Maximum Safety Sensing Distance	<table border="0"> <tr> <td></td> <td>Make</td> <td>Break</td> </tr> <tr> <td>Style S1</td> <td>5mm (0.20in)</td> <td>11mm (0.43in)</td> </tr> <tr> <td>Style S2</td> <td>9mm (0.35in)</td> <td>12mm (0.47in)</td> </tr> <tr> <td>Style S3</td> <td>5mm (0.20in)</td> <td>12mm (0.47in)</td> </tr> <tr> <td>Style S4</td> <td>10mm (0.39in)</td> <td>13mm (0.51in)</td> </tr> </table>		Make	Break	Style S1	5mm (0.20in)	11mm (0.43in)	Style S2	9mm (0.35in)	12mm (0.47in)	Style S3	5mm (0.20in)	12mm (0.47in)	Style S4	10mm (0.39in)	13mm (0.51in)
	Make	Break														
Style S1	5mm (0.20in)	11mm (0.43in)														
Style S2	9mm (0.35in)	12mm (0.47in)														
Style S3	5mm (0.20in)	12mm (0.47in)														
Style S4	10mm (0.39in)	13mm (0.51in)														
Auxiliary Contact Switching Capability	300VDC, 250VAC, 0.5A including inrush. 15VA/10W suitable for AC/DC circuits															
Operating Temperature	<table border="0"> <tr> <td>S1, S2, S3</td> <td>-10°C to +55°C (+14° to +131°F)</td> </tr> <tr> <td>S4 (GD2)</td> <td>-25°C to +125°C (-13° to +257°F)</td> </tr> </table>	S1, S2, S3	-10°C to +55°C (+14° to +131°F)	S4 (GD2)	-25°C to +125°C (-13° to +257°F)											
S1, S2, S3	-10°C to +55°C (+14° to +131°F)															
S4 (GD2)	-25°C to +125°C (-13° to +257°F)															
Enclosure Protection	<table border="0"> <tr> <td>S1, S2, S31</td> <td>IP67 (NEMA 6P)</td> </tr> <tr> <td>S4 (GD2)</td> <td>IP67 (NEMA 6P)</td> </tr> </table>	S1, S2, S31	IP67 (NEMA 6P)	S4 (GD2)	IP67 (NEMA 6P)											
S1, S2, S31	IP67 (NEMA 6P)															
S4 (GD2)	IP67 (NEMA 6P)															
Cable	<table border="0"> <tr> <td>S1</td> <td>0.54 mm² (20AWG) 4 wire PVC Jacket OD – 4mm (0.16in)</td> </tr> <tr> <td>S2</td> <td>0.54 mm² (20AWG) 4 wire PVC Jacket OD – 4mm (0.16in)</td> </tr> </table>	S1	0.54 mm ² (20AWG) 4 wire PVC Jacket OD – 4mm (0.16in)	S2	0.54 mm ² (20AWG) 4 wire PVC Jacket OD – 4mm (0.16in)											
S1	0.54 mm ² (20AWG) 4 wire PVC Jacket OD – 4mm (0.16in)															
S2	0.54 mm ² (20AWG) 4 wire PVC Jacket OD – 4mm (0.16in)															
Cable	<table border="0"> <tr> <td>S1</td> <td>0.54mm² (0.02in) (20AWG) 4 wire PVC jacket OD—4mm (0.16in)</td> </tr> <tr> <td>S2</td> <td>0.54mm² (0.02in) (20AWG) 4 wire PVC jacket OD—4mm (0.16in)</td> </tr> </table>	S1	0.54mm ² (0.02in) (20AWG) 4 wire PVC jacket OD—4mm (0.16in)	S2	0.54mm ² (0.02in) (20AWG) 4 wire PVC jacket OD—4mm (0.16in)											
S1	0.54mm ² (0.02in) (20AWG) 4 wire PVC jacket OD—4mm (0.16in)															
S2	0.54mm ² (0.02in) (20AWG) 4 wire PVC jacket OD—4mm (0.16in)															
Case Material	<table border="0"> <tr> <td>S1, S2</td> <td>Moulded ABS</td> </tr> <tr> <td>S30 (Actuator)</td> <td>Polyester</td> </tr> <tr> <td>S31 (Sensor)</td> <td>Nylon (Trogamid)</td> </tr> <tr> <td>S4 (GD2)</td> <td>Stainless Steel</td> </tr> </table>	S1, S2	Moulded ABS	S30 (Actuator)	Polyester	S31 (Sensor)	Nylon (Trogamid)	S4 (GD2)	Stainless Steel							
S1, S2	Moulded ABS															
S30 (Actuator)	Polyester															
S31 (Sensor)	Nylon (Trogamid)															
S4 (GD2)	Stainless Steel															
Mounting	Any Position															
Weight (not including cable)	<table border="0"> <tr> <td>S1</td> <td>Sensor Actuator</td> </tr> <tr> <td>S2</td> <td>18g (0.04lbs) 15g (0.03lbs)</td> </tr> <tr> <td>S3</td> <td>20g (0.04lbs) 30g (0.07lbs)</td> </tr> <tr> <td>S4</td> <td>18g (0.04lbs) 6g (0.01lbs) 150g (0.33lbs) 170g (0.37lbs)</td> </tr> </table>	S1	Sensor Actuator	S2	18g (0.04lbs) 15g (0.03lbs)	S3	20g (0.04lbs) 30g (0.07lbs)	S4	18g (0.04lbs) 6g (0.01lbs) 150g (0.33lbs) 170g (0.37lbs)							
S1	Sensor Actuator															
S2	18g (0.04lbs) 15g (0.03lbs)															
S3	20g (0.04lbs) 30g (0.07lbs)															
S4	18g (0.04lbs) 6g (0.01lbs) 150g (0.33lbs) 170g (0.37lbs)															
Shock	30g, 11ms half-sine															
Vibration	1mm, 10 to 55Hz															

Product Selection

Housing Style	Housing	Safety Contacts	Auxiliary Contacts	Type	Connection	Catalogue Number
 S1	ABS Plastic	1 N.C. & 1 N.O.	None	S11	3m Cable	440N-S32014
					10m Cable	440N-S32016
			1 N.C.	S12	3m Cable	440N-S32022
					10m Cable	440N-S32032
			1 N.O.	S13	3m Cable	440N-S32037
					10m Cable	440N-S32036
 S2	ABS Plastic	1 N.C. & 1 N.O.	None	S21	3m Cable	440N-S32015
					10m Cable	440N-S32017
			1 N.C.	S22	3m Cable	440N-S32023
					10m Cable	440N-S32033
			1 N.O.	S23	3m Cable	440N-S32038
					10m Cable	440N-S32039
 S3	Polyester (Actuator) Nylon [Trogamid] (Sensor)	1 N.C. & 1 N.O.	None	S31	4 Pin Micro QD	440N-S32024
			1 N.C.	S42	8 Pin Micro QD	440N-S32047
 S4	Stainless Steel	1 N.C. & 1 N.O.	1 N.O.	S43		8 Pin Micro QD
			Mating cable, 4-pin straight 2m. See page 15-10 for details and additional lengths.			
Mating cable, 4-pin straight 5m. See page 15-10 for details and additional lengths.					889D-F4AC-5	
Mating cable, 4-pin straight 10m. See page 15-10 for details and additional lengths.					889D-F4AC-10	
Mating cable, 8-pin/7-wire straight 2m. See page 15-10 for details and additional lengths.					889D-F8AC-2	
Mating cable, 8-pin/7-wire straight 5m. See page 15-10 for details and additional lengths.					889D-F8AC-5	
Mating cable, 8-pin/7-wire straight 10m. See page 15-10 for details and additional lengths.					889D-F8AC-10	

Note: Contacts are described with the guard door closed, that is, actuator in place. Switch is shipped complete with actuator.

Accessories

Description	Page Number	Catalogue Number
Actuator S10	—	440N-A32019
Actuator S20		440N-A32020
Actuator S30		440N-A32025
Actuator S40 (GD2)		440N-A32041

Interlock Switches

Non contact Switches

Sipha Sensors

Approximate Dimensions—mm (inches)

Dimensions are not intended to be used for installation purposes.

Sipha S1

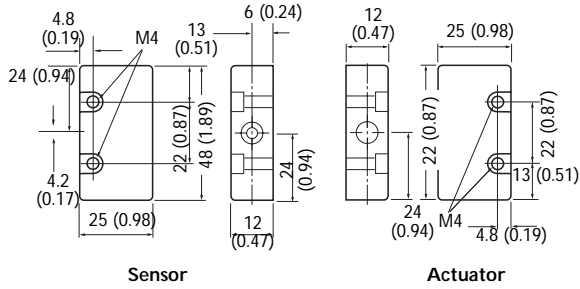

Sipha S2

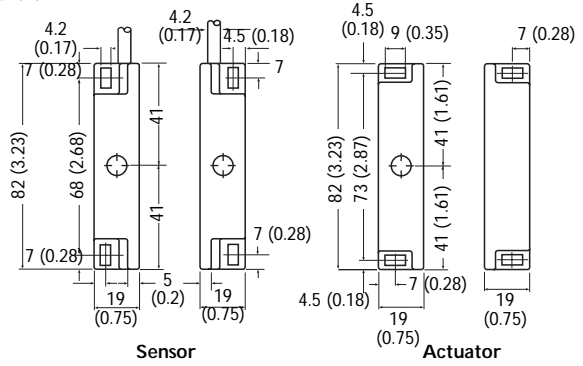

Sipha S3

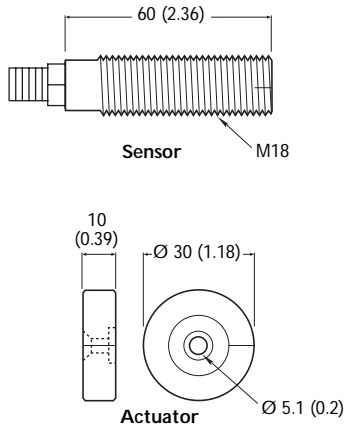

Sipha S4

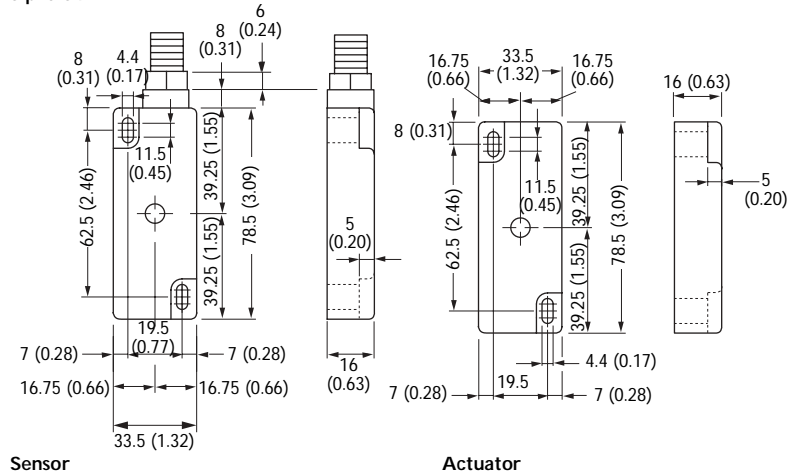

Typical Wiring Diagrams

S11, S21

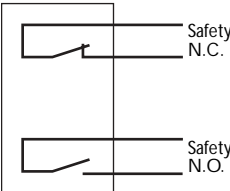

S12, S22

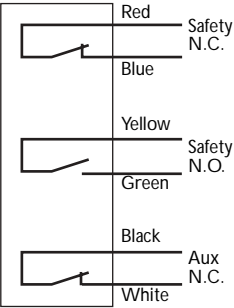

S13, S23

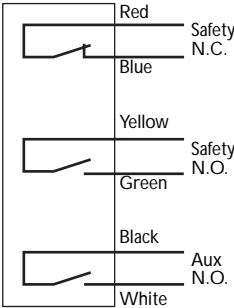

S31

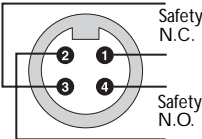

S42

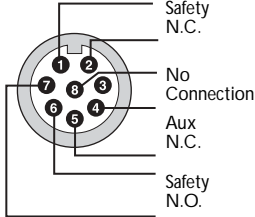

S43

