



# CY7C1471BV25 CY7C1473BV25, CY7C1475BV25

## 72-Mbit (2M x 36/4M x 18/1M x 72) Flow-Through SRAM with NoBL™ Architecture

### Features

- No Bus Latency™ (NoBL™) architecture eliminates dead cycles between write and read cycles
- Supports up to 133 MHz bus operations with zero wait states
- Data transfers on every clock
- Pin compatible and functionally equivalent to ZBT™ devices
- Internally self timed output buffer control to eliminate the need to use OE
- Registered inputs for flow through operation
- Byte Write capability
- 2.5V IO supply (V<sub>DDQ</sub>)
- Fast clock-to-output times
  - 6.5 ns (for 133-MHz device)
- Clock Enable ( $\overline{CEN}$ ) pin to enable clock and suspend operation
- Synchronous self timed writes
- Asynchronous Output Enable ( $\overline{OE}$ )
- CY7C1471BV25, CY7C1473BV25 available in JEDEC-standard Pb-free 100-pin TQFP, Pb-free and non-Pb-free 165-ball FBGA package. CY7C1475BV25 available in Pb-free and non-Pb-free 209-ball FBGA package.
- Three Chip Enables ( $\overline{CE}_1$ ,  $\overline{CE}_2$ ,  $\overline{CE}_3$ ) for simple depth expansion.
- Automatic power down feature available using ZZ mode or CE deselect.
- IEEE 1149.1 JTAG Boundary Scan compatible
- Burst Capability - linear or interleaved burst order
- Low standby power

### Selection Guide

Description	133 MHz	100 MHz	Unit
Maximum Access Time	6.5	8.5	ns
Maximum Operating Current	305	275	mA
Maximum CMOS Standby Current	120	120	mA

### Functional Description

The CY7C1471BV25, CY7C1473BV25, and CY7C1475BV25 are 2.5V, 2M x 36/4M x 18/1M x 72 synchronous flow through burst SRAMs designed specifically to support unlimited true back-to-back read or write operations without the insertion of wait states. The CY7C1471BV25, CY7C1473BV25, and CY7C1475BV25 are equipped with the advanced No Bus Latency (NoBL) logic required to enable consecutive read or write operations with data transferred on every clock cycle. This feature dramatically improves the throughput of data through the SRAM, especially in systems that require frequent write-read transitions.

All synchronous inputs pass through input registers controlled by the rising edge of the clock. The clock input is qualified by the Clock Enable ( $\overline{CEN}$ ) signal, which when deasserted suspends operation and extends the previous clock cycle. Maximum access delay from the clock rise is 6.5 ns (133-MHz device).

Write operations are controlled by two or four Byte Write Select ( $\overline{BW}_x$ ) and a Write Enable ( $\overline{WE}$ ) input. All writes are conducted with on-chip synchronous self timed write circuitry.

Three synchronous Chip Enables ( $\overline{CE}_1$ ,  $\overline{CE}_2$ ,  $\overline{CE}_3$ ) and an asynchronous Output Enable ( $\overline{OE}$ ) provide easy bank selection and output tri-state control. To avoid bus contention, the output drivers are synchronously tri-stated during the data portion of a write sequence.

For best practice recommendations, refer to the Cypress application note [AN1064, SRAM System Guidelines](#).

**Logic Block Diagram – CY7C1471BV25 (2M x 36)**

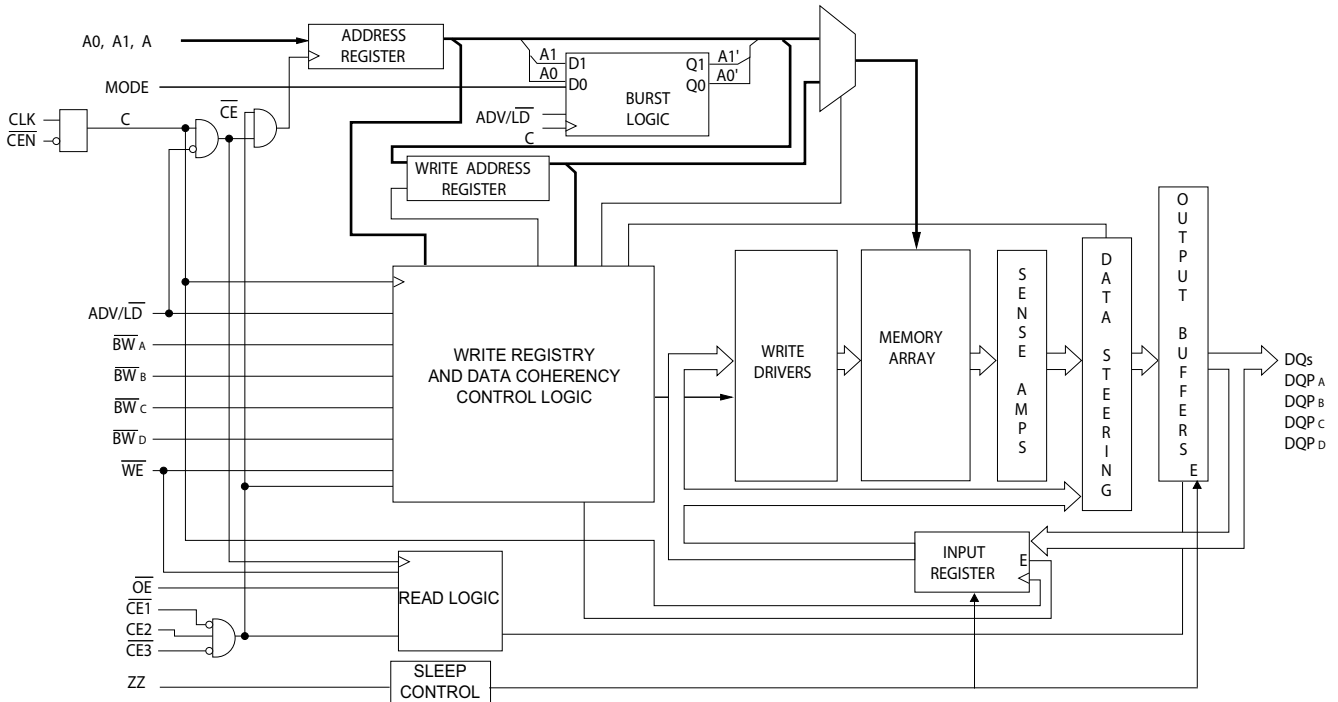

**Logic Block Diagram – CY7C1473BV25 (4M x 18)**

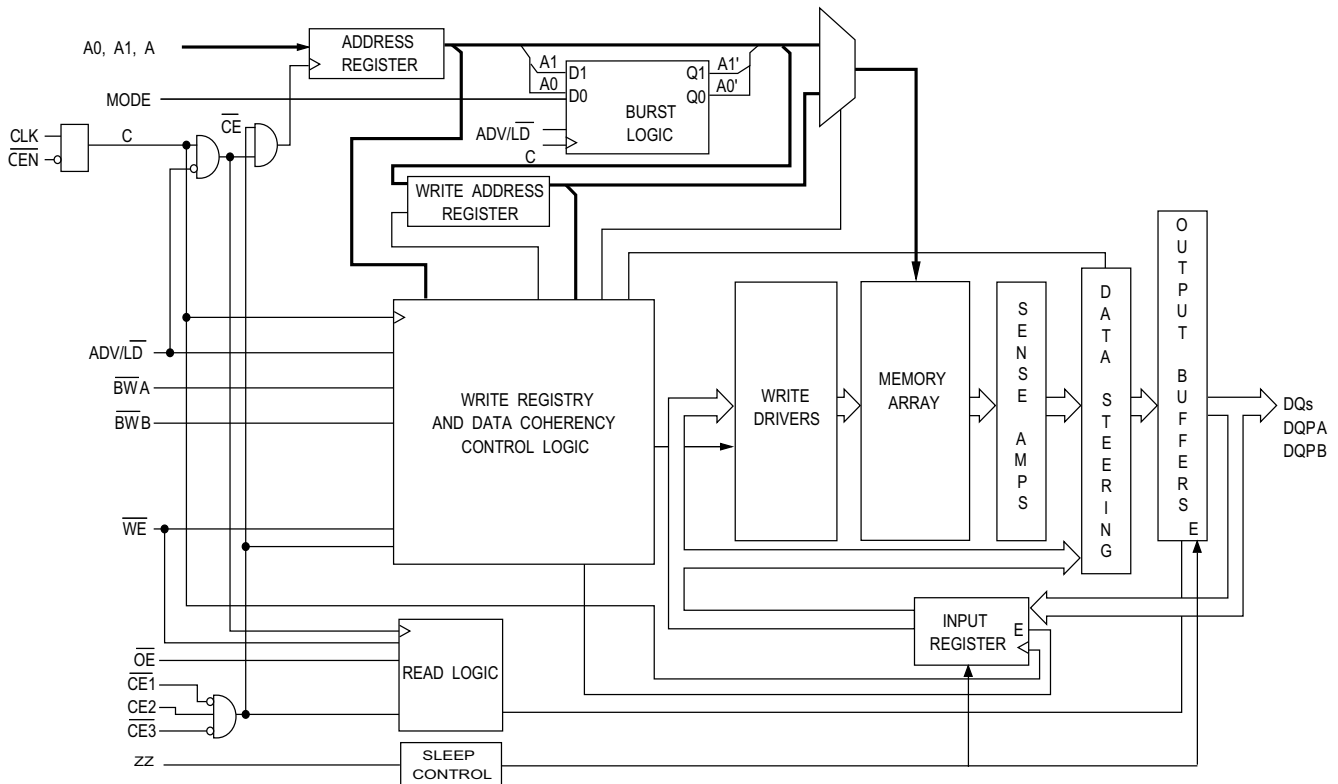

Logic Block Diagram – CY7C1475BV25 (1M x 72)

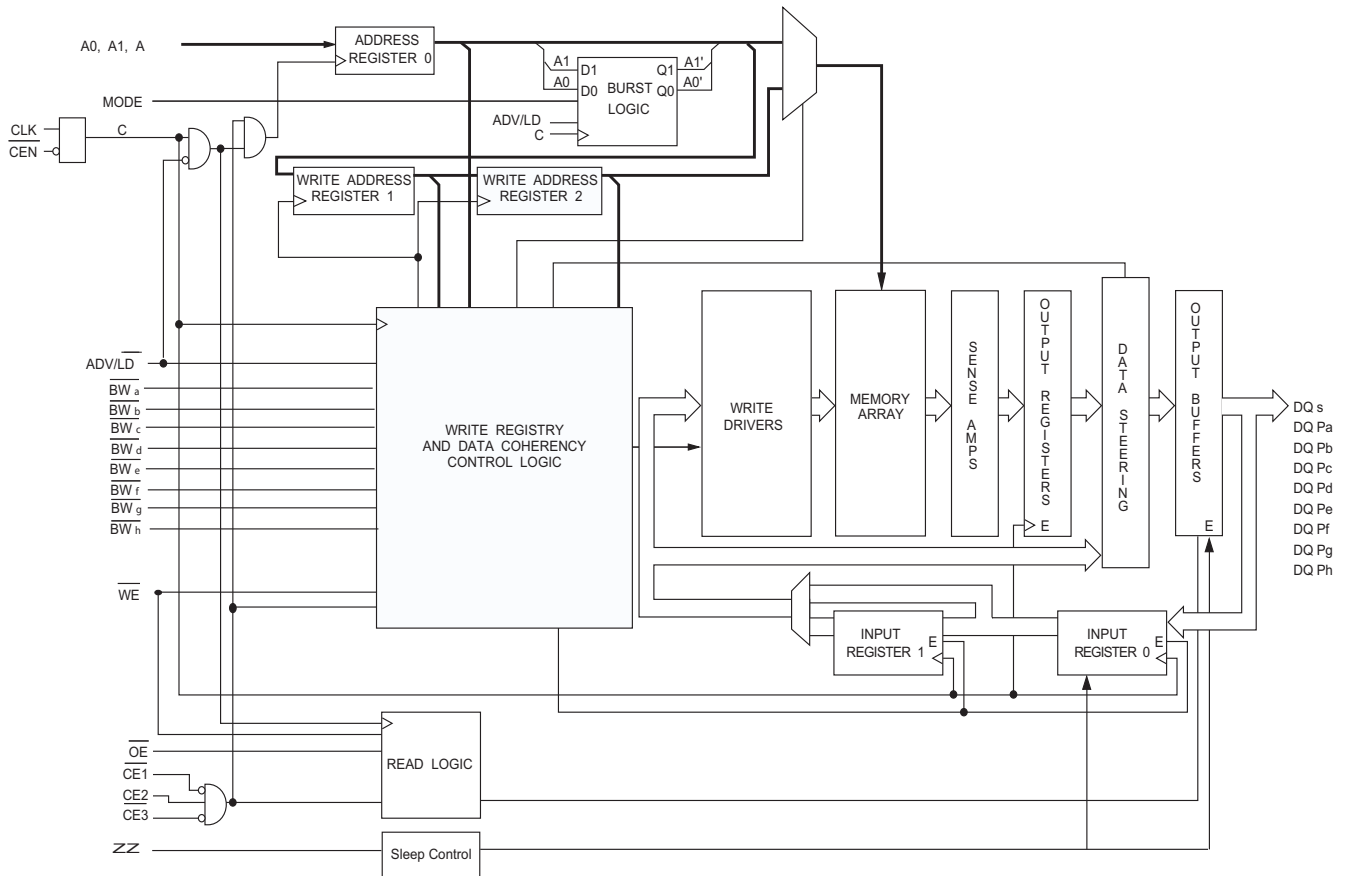

**Pin Configurations**

**Figure 1. 100- Pin TQFP Pinout**

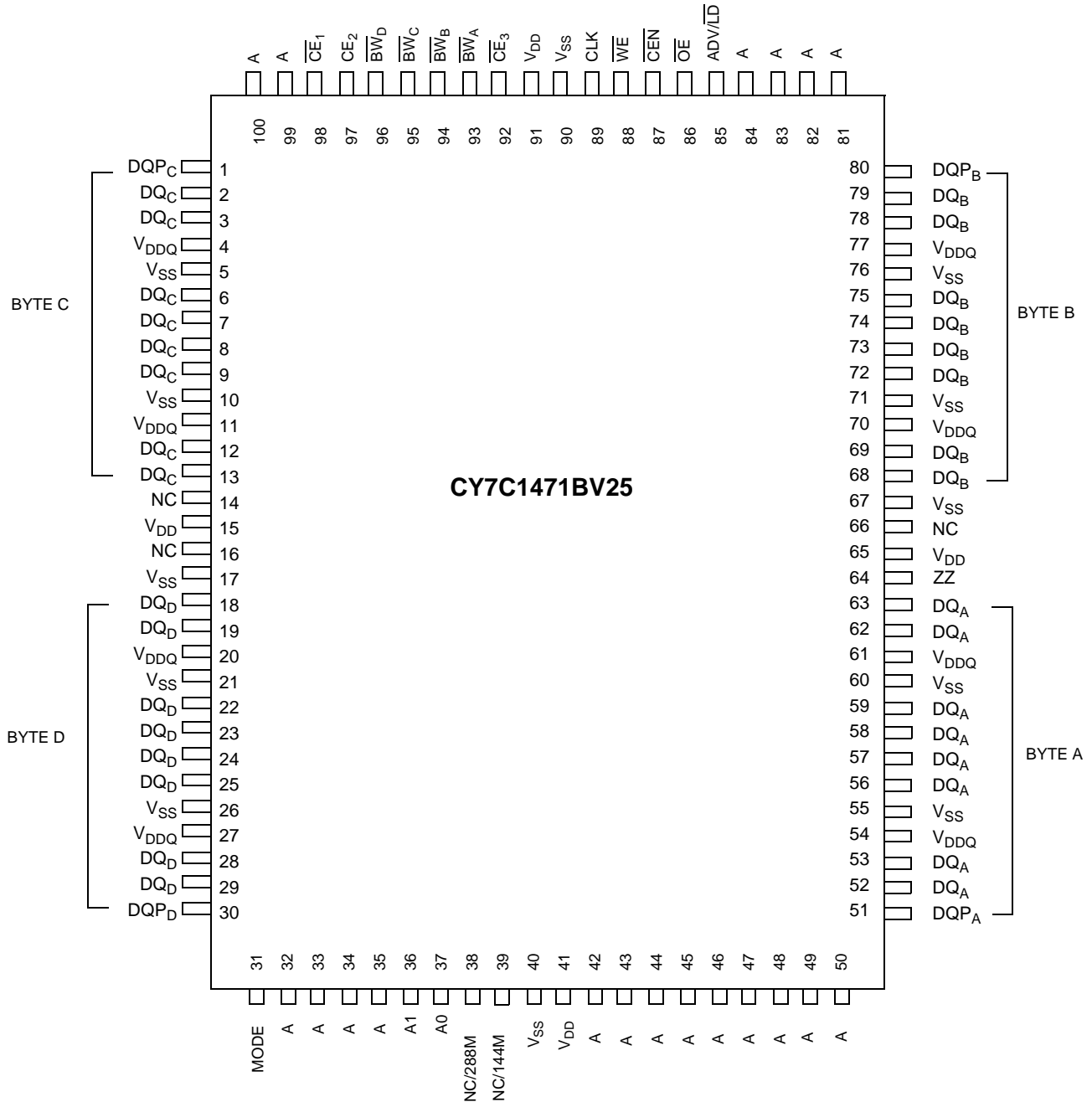

**Pin Configurations** (continued)

**Figure 2. 100-Pin TQFP Pinout**

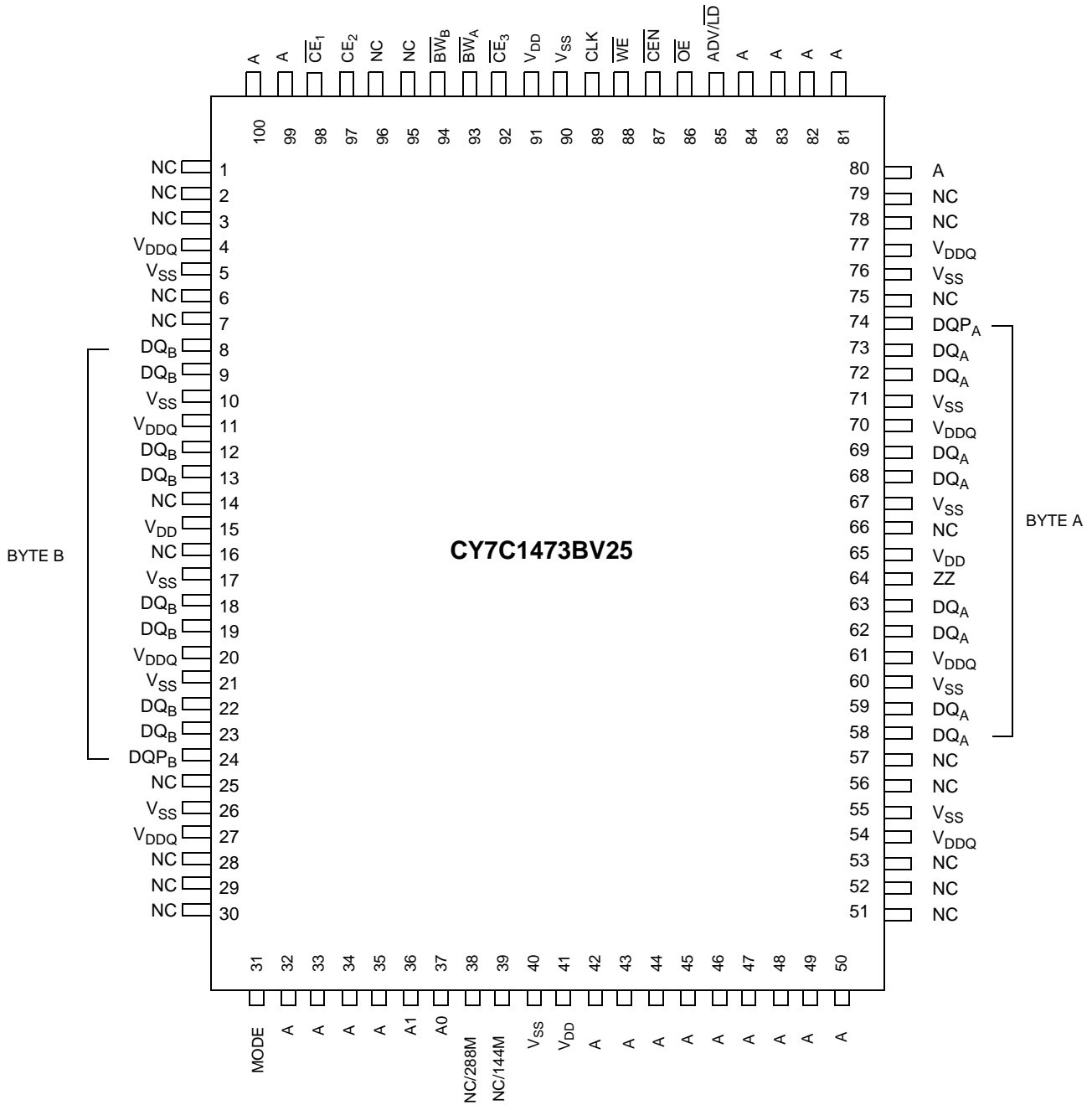

**Pin Configurations** (continued)

**165-Ball FBGA (15 x 17 x 1.4 mm) Pinout**  
**CY7C1471BV25 (2M x 36)**

	1	2	3	4	5	6	7	8	9	10	11
<b>A</b>	NC/576M	A	$\overline{CE}_1$	$\overline{BW}_C$	$\overline{BW}_B$	$\overline{CE}_3$	$\overline{CEN}$	ADV/LD	A	A	NC
<b>B</b>	NC/1G	A	CE2	$\overline{BW}_D$	$\overline{BW}_A$	CLK	$\overline{WE}$	$\overline{OE}$	A	A	NC
<b>C</b>	DQP <sub>C</sub>	NC	V <sub>DDQ</sub>	V <sub>SS</sub>	V <sub>SS</sub>	V <sub>SS</sub>	V <sub>SS</sub>	V <sub>SS</sub>	V <sub>DDQ</sub>	NC	DQP <sub>B</sub>
<b>D</b>	DQ <sub>C</sub>	DQ <sub>C</sub>	V <sub>DDQ</sub>	V <sub>DD</sub>	V <sub>SS</sub>	V <sub>SS</sub>	V <sub>SS</sub>	V <sub>DD</sub>	V <sub>DDQ</sub>	DQ <sub>B</sub>	DQ <sub>B</sub>
<b>E</b>	DQ <sub>C</sub>	DQ <sub>C</sub>	V <sub>DDQ</sub>	V <sub>DD</sub>	V <sub>SS</sub>	V <sub>SS</sub>	V <sub>SS</sub>	V <sub>DD</sub>	V <sub>DDQ</sub>	DQ <sub>B</sub>	DQ <sub>B</sub>
<b>F</b>	DQ <sub>C</sub>	DQ <sub>C</sub>	V <sub>DDQ</sub>	V <sub>DD</sub>	V <sub>SS</sub>	V <sub>SS</sub>	V <sub>SS</sub>	V <sub>DD</sub>	V <sub>DDQ</sub>	DQ <sub>B</sub>	DQ <sub>B</sub>
<b>G</b>	DQ <sub>C</sub>	DQ <sub>C</sub>	V <sub>DDQ</sub>	V <sub>DD</sub>	V <sub>SS</sub>	V <sub>SS</sub>	V <sub>SS</sub>	V <sub>DD</sub>	V <sub>DDQ</sub>	DQ <sub>B</sub>	DQ <sub>B</sub>
<b>H</b>	NC	NC	NC	V <sub>DD</sub>	V <sub>SS</sub>	V <sub>SS</sub>	V <sub>SS</sub>	V <sub>DD</sub>	NC	NC	ZZ
<b>J</b>	DQ <sub>D</sub>	DQ <sub>D</sub>	V <sub>DDQ</sub>	V <sub>DD</sub>	V <sub>SS</sub>	V <sub>SS</sub>	V <sub>SS</sub>	V <sub>DD</sub>	V <sub>DDQ</sub>	DQ <sub>A</sub>	DQ <sub>A</sub>
<b>K</b>	DQ <sub>D</sub>	DQ <sub>D</sub>	V <sub>DDQ</sub>	V <sub>DD</sub>	V <sub>SS</sub>	V <sub>SS</sub>	V <sub>SS</sub>	V <sub>DD</sub>	V <sub>DDQ</sub>	DQ <sub>A</sub>	DQ <sub>A</sub>
<b>L</b>	DQ <sub>D</sub>	DQ <sub>D</sub>	V <sub>DDQ</sub>	V <sub>DD</sub>	V <sub>SS</sub>	V <sub>SS</sub>	V <sub>SS</sub>	V <sub>DD</sub>	V <sub>DDQ</sub>	DQ <sub>A</sub>	DQ <sub>A</sub>
<b>M</b>	DQ <sub>D</sub>	DQ <sub>D</sub>	V <sub>DDQ</sub>	V <sub>DD</sub>	V <sub>SS</sub>	V <sub>SS</sub>	V <sub>SS</sub>	V <sub>DD</sub>	V <sub>DDQ</sub>	DQ <sub>A</sub>	DQ <sub>A</sub>
<b>N</b>	DQP <sub>D</sub>	NC	V <sub>DDQ</sub>	V <sub>SS</sub>	NC	NC	NC	V <sub>SS</sub>	V <sub>DDQ</sub>	NC	DQP <sub>A</sub>
<b>P</b>	NC/144M	A	A	A	TDI	A1	TDO	A	A	A	NC/288M
<b>R</b>	MODE	A	A	A	TMS	A0	TCK	A	A	A	A

**CY7C1473BV25 (4M x 18)**

	1	2	3	4	5	6	7	8	9	10	11
<b>A</b>	NC/576M	A	$\overline{CE}_1$	$\overline{BW}_B$	NC	$\overline{CE}_3$	$\overline{CEN}$	ADV/LD	A	A	A
<b>B</b>	NC/1G	A	CE2	NC	$\overline{BW}_A$	CLK	$\overline{WE}$	$\overline{OE}$	A	A	NC
<b>C</b>	NC	NC	V <sub>DDQ</sub>	V <sub>SS</sub>	V <sub>SS</sub>	V <sub>SS</sub>	V <sub>SS</sub>	V <sub>SS</sub>	V <sub>DDQ</sub>	NC	DQP <sub>A</sub>
<b>D</b>	NC	DQ <sub>B</sub>	V <sub>DDQ</sub>	V <sub>DD</sub>	V <sub>SS</sub>	V <sub>SS</sub>	V <sub>SS</sub>	V <sub>DD</sub>	V <sub>DDQ</sub>	NC	DQ <sub>A</sub>
<b>E</b>	NC	DQ <sub>B</sub>	V <sub>DDQ</sub>	V <sub>DD</sub>	V <sub>SS</sub>	V <sub>SS</sub>	V <sub>SS</sub>	V <sub>DD</sub>	V <sub>DDQ</sub>	NC	DQ <sub>A</sub>
<b>F</b>	NC	DQ <sub>B</sub>	V <sub>DDQ</sub>	V <sub>DD</sub>	V <sub>SS</sub>	V <sub>SS</sub>	V <sub>SS</sub>	V <sub>DD</sub>	V <sub>DDQ</sub>	NC	DQ <sub>A</sub>
<b>G</b>	NC	DQ <sub>B</sub>	V <sub>DDQ</sub>	V <sub>DD</sub>	V <sub>SS</sub>	V <sub>SS</sub>	V <sub>SS</sub>	V <sub>DD</sub>	V <sub>DDQ</sub>	NC	DQ <sub>A</sub>
<b>H</b>	NC	NC	NC	V <sub>DD</sub>	V <sub>SS</sub>	V <sub>SS</sub>	V <sub>SS</sub>	V <sub>DD</sub>	NC	NC	ZZ
<b>J</b>	DQ <sub>B</sub>	NC	V <sub>DDQ</sub>	V <sub>DD</sub>	V <sub>SS</sub>	V <sub>SS</sub>	V <sub>SS</sub>	V <sub>DD</sub>	V <sub>DDQ</sub>	DQ <sub>A</sub>	NC
<b>K</b>	DQ <sub>B</sub>	NC	V <sub>DDQ</sub>	V <sub>DD</sub>	V <sub>SS</sub>	V <sub>SS</sub>	V <sub>SS</sub>	V <sub>DD</sub>	V <sub>DDQ</sub>	DQ <sub>A</sub>	NC
<b>L</b>	DQ <sub>B</sub>	NC	V <sub>DDQ</sub>	V <sub>DD</sub>	V <sub>SS</sub>	V <sub>SS</sub>	V <sub>SS</sub>	V <sub>DD</sub>	V <sub>DDQ</sub>	DQ <sub>A</sub>	NC
<b>M</b>	DQ <sub>B</sub>	NC	V <sub>DDQ</sub>	V <sub>DD</sub>	V <sub>SS</sub>	V <sub>SS</sub>	V <sub>SS</sub>	V <sub>DD</sub>	V <sub>DDQ</sub>	DQ <sub>A</sub>	NC
<b>N</b>	DQP <sub>B</sub>	NC	V <sub>DDQ</sub>	V <sub>SS</sub>	NC	NC	NC	V <sub>SS</sub>	V <sub>DDQ</sub>	NC	NC
<b>P</b>	NC/144M	A	A	A	TDI	A1	TDO	A	A	A	NC/288M
<b>R</b>	MODE	A	A	A	TMS	A0	TCK	A	A	A	A

**Pin Configurations** (continued)

**209-Ball FBGA (14 x 22 x 1.76 mm) Pinout**  
**CY7C1475BV25 (1M x 72)**

	1	2	3	4	5	6	7	8	9	10	11
<b>A</b>	DQg	DQg	A	CE <sub>2</sub>	A	ADV/LD	A	CE <sub>3</sub>	A	DQb	DQb
<b>B</b>	DQg	DQg	BWS <sub>c</sub>	BWS <sub>g</sub>	NC	WE	A	BWS <sub>b</sub>	BWS <sub>f</sub>	DQb	DQb
<b>C</b>	DQg	DQg	BWS <sub>h</sub>	BWS <sub>d</sub>	NC/576M	CE <sub>1</sub>	NC	BWS <sub>e</sub>	BWS <sub>a</sub>	DQb	DQb
<b>D</b>	DQg	DQg	V <sub>SS</sub>	NC	NC/1G	OE	NC	NC	V <sub>SS</sub>	DQb	DQb
<b>E</b>	DQPg	DQPc	V <sub>DDQ</sub>	V <sub>DDQ</sub>	V <sub>DD</sub>	V <sub>DD</sub>	V <sub>DD</sub>	V <sub>DDQ</sub>	V <sub>DDQ</sub>	DQPf	DQPb
<b>F</b>	DQc	DQc	V <sub>SS</sub>	V <sub>SS</sub>	V <sub>SS</sub>	NC	V <sub>SS</sub>	V <sub>SS</sub>	V <sub>SS</sub>	DQf	DQf
<b>G</b>	DQc	DQc	V <sub>DDQ</sub>	V <sub>DDQ</sub>	V <sub>DD</sub>	NC	V <sub>DD</sub>	V <sub>DDQ</sub>	V <sub>DDQ</sub>	DQf	DQf
<b>H</b>	DQc	DQc	V <sub>SS</sub>	V <sub>SS</sub>	V <sub>SS</sub>	NC	V <sub>SS</sub>	V <sub>SS</sub>	V <sub>SS</sub>	DQf	DQf
<b>J</b>	DQc	DQc	V <sub>DDQ</sub>	V <sub>DDQ</sub>	V <sub>DD</sub>	NC	V <sub>DD</sub>	V <sub>DDQ</sub>	V <sub>DDQ</sub>	DQf	DQf
<b>K</b>	NC	NC	CLK	NC	V <sub>SS</sub>	CEN	V <sub>SS</sub>	NC	NC	NC	NC
<b>L</b>	DQh	DQh	V <sub>DDQ</sub>	V <sub>DDQ</sub>	V <sub>DD</sub>	NC	V <sub>DD</sub>	V <sub>DDQ</sub>	V <sub>DDQ</sub>	DQa	DQa
<b>M</b>	DQh	DQh	V <sub>SS</sub>	V <sub>SS</sub>	V <sub>SS</sub>	NC	V <sub>SS</sub>	V <sub>SS</sub>	V <sub>SS</sub>	DQa	DQa
<b>N</b>	DQh	DQh	V <sub>DDQ</sub>	V <sub>DDQ</sub>	V <sub>DD</sub>	NC	V <sub>DD</sub>	V <sub>DDQ</sub>	V <sub>DDQ</sub>	DQa	DQa
<b>P</b>	DQh	DQh	V <sub>SS</sub>	V <sub>SS</sub>	V <sub>SS</sub>	ZZ	V <sub>SS</sub>	V <sub>SS</sub>	V <sub>SS</sub>	DQa	DQa
<b>R</b>	DQPd	DQPd	V <sub>DDQ</sub>	V <sub>DDQ</sub>	V <sub>DD</sub>	V <sub>DD</sub>	V <sub>DD</sub>	V <sub>DDQ</sub>	V <sub>DDQ</sub>	DQPd	DQPd
<b>T</b>	DQd	DQd	V <sub>SS</sub>	NC	NC	MODE	NC	NC	V <sub>SS</sub>	DQe	DQe
<b>U</b>	DQd	DQd	NC/144M	A	A	A	A	A	NC/288M	DQe	DQe
<b>V</b>	DQd	DQd	A	A	A	A1	A	A	A	DQe	DQe
<b>W</b>	DQd	DQd	TMS	TDI	A	A0	A	TDO	TCK	DQe	DQe

**Table 1. Pin Definitions**

Name	IO	Description
A <sub>0</sub> , A <sub>1</sub> , A	Input-Synchronous	<b>Address Inputs Used to Select One of the Address Locations.</b> Sampled at the rising edge of the CLK. A <sub>[1:0]</sub> are fed to the two-bit burst counter.
$\overline{BW}_A$ , $\overline{BW}_B$ , $\overline{BW}_C$ , $\overline{BW}_D$ , $\overline{BW}_E$ , $\overline{BW}_F$ , $\overline{BW}_G$ , $\overline{BW}_H$	Input-Synchronous	<b>Byte Write Inputs, Active LOW.</b> Qualified with $\overline{WE}$ to conduct writes to the SRAM. Sampled on the rising edge of CLK.
$\overline{WE}$	Input-Synchronous	<b>Write Enable Input, Active LOW.</b> Sampled on the rising edge of CLK if $\overline{CEN}$ is active LOW. This signal must be asserted LOW to initiate a write sequence.
$\overline{ADV/LD}$	Input-Synchronous	<b>Advance/Load Input.</b> Used to advance the on-chip address counter or load a new address. When HIGH (and $\overline{CEN}$ is asserted LOW) the internal burst counter is advanced. When $\overline{LOW}$ , a new address can be loaded into the device for an access. After being deselected, $\overline{ADV/LD}$ must be driven LOW to load a new address.
CLK	Input-Clock	<b>Clock Input.</b> Captures all synchronous inputs to the device. CLK is qualified with $\overline{CEN}$ . CLK is only recognized if $\overline{CEN}$ is active LOW.
$\overline{CE}_1$	Input-Synchronous	<b>Chip Enable 1 Input, Active LOW.</b> Sampled on the rising edge of CLK. Used in conjunction with $\overline{CE}_2$ and $\overline{CE}_3$ to select or deselect the device.
$\overline{CE}_2$	Input-Synchronous	<b>Chip Enable 2 Input, Active HIGH.</b> Sampled on the rising edge of CLK. Used in conjunction with $\overline{CE}_1$ and $\overline{CE}_3$ to select or deselect the device.
$\overline{CE}_3$	Input-Synchronous	<b>Chip Enable 3 Input, Active LOW.</b> Sampled on the rising edge of CLK. Used in conjunction with $\overline{CE}_1$ and $\overline{CE}_2$ to select or deselect the device.
$\overline{OE}$	Input-Asynchronous	<b>Output Enable, Asynchronous Input, Active LOW.</b> Combined with the synchronous logic block inside the device to control the direction of the IO pins. When LOW, the IO pins are enabled to behave as outputs. When deasserted HIGH, IO pins are tri-stated, and act as input data pins. $\overline{OE}$ is masked during the data portion of a write sequence, during the first clock when emerging from a deselected state, when the device has been deselected.
$\overline{CEN}$	Input-Synchronous	<b>Clock Enable Input, Active LOW.</b> When asserted LOW the clock signal is recognized by the SRAM. When deasserted HIGH the clock signal is masked. Because deasserting $\overline{CEN}$ does not deselect the device, $\overline{CEN}$ can be used to extend the previous cycle when required.
ZZ	Input-Asynchronous	<b>ZZ “Sleep” Input.</b> This active HIGH input places the device in a non-time-critical “sleep” condition with data integrity preserved. For normal operation, this pin must be LOW or left floating. ZZ pin has an internal pull down.
DQ <sub>s</sub>	IO-Synchronous	<b>Bidirectional Data IO Lines.</b> As inputs, they feed into an on-chip data register that is triggered by the rising edge of CLK. As outputs, they deliver the data contained in the memory location specified by the addresses presented during the previous clock rise of the read cycle. The direction of the pins is controlled by $\overline{OE}$ . When $\overline{OE}$ is asserted LOW, the pins behave as outputs. When HIGH, DQ <sub>s</sub> and DQP <sub>x</sub> are placed in a tri-state condition. The outputs are automatically tri-stated during the data portion of a write sequence, during the first clock when emerging from a deselected state, and when the device is deselected, regardless of the state of $\overline{OE}$ .
DQP <sub>x</sub>	IO-Synchronous	<b>Bidirectional Data Parity IO Lines.</b> Functionally, these signals are identical to DQ <sub>s</sub> . During write sequences, DQP <sub>x</sub> is controlled by $\overline{BW}_x$ correspondingly.
MODE	Input Strap Pin	<b>Mode Input. Selects the Burst Order of the Device.</b> When tied to Gnd selects linear burst sequence. When tied to V <sub>DD</sub> or left floating selects interleaved burst sequence.
V <sub>DD</sub>	Power Supply	<b>Power Supply Inputs to the Core of the Device.</b>
V <sub>DDQ</sub>	IO Power Supply	<b>Power Supply for the IO Circuitry.</b>
V <sub>SS</sub>	Ground	<b>Ground for the Device.</b>
TDO	JTAG serial output Synchronous	<b>Serial Data Out to the JTAG Circuit.</b> Delivers data on the negative edge of TCK. If the JTAG feature is not used, this pin must be left unconnected. This pin is not available on TQFP packages.



**Table 1. Pin Definitions** (continued)

Name	IO	Description
TDI	JTAG serial input Synchronous	<b>Serial Data In to the JTAG Circuit.</b> Sampled on the rising edge of TCK. If the JTAG feature is not used, leave this pin floating or connected to V <sub>DD</sub> through a pull up resistor. This pin is not available on TQFP packages.
TMS	JTAG serial input Synchronous	<b>Serial Data In to the JTAG Circuit.</b> Sampled on the rising edge of TCK. If the JTAG feature is not used, this pin can be disconnected or connected to V <sub>DD</sub> . This pin is not available on TQFP packages.
TCK	JTAG-Clock	<b>Clock Input to the JTAG Circuitry.</b> If the JTAG feature is not used, connect this pin to V <sub>SS</sub> . This pin is not available on TQFP packages.
NC	-	<b>No Connects.</b> Not internally connected to the die. 144M, 288M, 576M, and 1G are address expansion pins and are not internally connected to the die.

## Functional Overview

The CY7C1471BV25, CY7C1473BV25, and CY7C1475BV25 are synchronous flow through burst SRAMs designed specifically to eliminate wait states during write read transitions. All synchronous inputs pass through input registers controlled by the rising edge of the clock. The clock signal is qualified with the Clock Enable input signal (CEN). If CEN is HIGH, the clock signal is not recognized and all internal states are maintained. All synchronous operations are qualified with  $\overline{CEN}$ . Maximum access delay from the clock rise ( $t_{CDV}$ ) is 6.5 ns (133-MHz device).

Accesses are initiated by asserting all three Chip Enables ( $\overline{CE}_1$ ,  $CE_2$ ,  $CE_3$ ) active at the rising edge of the clock. If CEN is active LOW and ADV/LD is asserted LOW, the address presented to the device is latched. The access is either a read or write operation, depending on the status of the Write Enable (WE). Use Byte Write Select ( $\overline{BW}_X$ ) to conduct Byte Write operations.

Write operations are qualified by the  $\overline{WE}$ . All writes are simplified with on-chip synchronous self-timed write circuitry.

Three synchronous Chip Enables ( $\overline{CE}_1$ ,  $CE_2$ ,  $\overline{CE}_3$ ) and an asynchronous Output Enable ( $\overline{OE}$ ) simplify depth expansion. All operations (reads, writes, and deselected) are pipelined. ADV/LD must be driven LOW after the device is deselected to load a new address for the next operation.

### Single Read Accesses

A read access is initiated when the following conditions are satisfied at clock rise:

- $\overline{CEN}$  is asserted LOW
- $\overline{CE}_1$ ,  $CE_2$ , and  $\overline{CE}_3$  are ALL asserted active
- $\overline{WE}$  is deasserted HIGH
- ADV/ $\overline{LD}$  is asserted LOW.

The address presented to the address inputs is latched into the Address Register and presented to the memory array and control logic. The control logic determines that a read access is in progress and allows the requested data to propagate to the output buffers. The data is available within 6.5 ns (133-MHz device) provided  $\overline{OE}$  is active LOW. After the first clock of the read access, the output buffers are controlled by  $\overline{OE}$  and the internal control logic.  $\overline{OE}$  must be driven LOW to drive out the requested data. On the subsequent clock, another operation (read/write/deselect) can be initiated. When the SRAM is

deselected at clock rise by one of the chip enable signals, the output is tri-stated immediately.

### Burst Read Accesses

The CY7C1471BV25, CY7C1473BV25, and CY7C1475BV25 has an on-chip burst counter that enables the user the ability to supply a single address and conduct up to four reads without reasserting the address inputs. ADV/LD must be driven LOW to load a new address into the SRAM, as described in the Single Read Access section. The sequence of the burst counter is determined by the MODE input signal. A LOW input on MODE selects a linear burst mode, a HIGH selects an interleaved burst sequence. Both burst counters use A0 and A1 in the burst sequence, and wraps around when incremented sufficiently. A HIGH input on ADV/LD increments the internal burst counter regardless of the state of chip enable inputs or WE. WE is latched at the beginning of a burst cycle. Therefore, the type of access (read or write) is maintained throughout the burst sequence.

### Single Write Accesses

Write accesses are initiated when these conditions are satisfied at clock rise:

- $\overline{CEN}$  is asserted LOW
- $\overline{CE}_1$ ,  $CE_2$ , and  $\overline{CE}_3$  are ALL asserted active
- $\overline{WE}$  is asserted LOW.

The address presented to the address bus is loaded into the Address Register. The write signals are latched into the Control Logic block. The data lines are automatically tri-stated regardless of the state of the OE input signal. This allows the external logic to present the data on DQs and DQP<sub>X</sub>.

On the next clock rise the data presented to DQs and DQP<sub>X</sub> (or a subset for Byte Write operations, see "Truth Table for Read/Write" on page 12 for details) inputs is latched into the device and the write is complete. Additional accesses (read/write/deselect) can be initiated on this cycle.

The data written during the write operation is controlled by  $\overline{BW}_X$  signals. The CY7C1471BV25, CY7C1473BV25, and CY7C1475BV25 provide Byte Write capability that is described in the "Truth Table for Read/Write" on page 12. The input WE with the selected  $\overline{BW}_X$  input selectively writes to only the desired bytes. Bytes not selected during a Byte Write operation remain unaltered. A synchronous self-timed write mechanism is provided to simplify the write operations. Byte Write capability is

included to greatly simplify read/modify/write sequences, which can be reduced to simple byte write operations.

Because the CY7C1471BV25, CY7C1473BV25, and CY7C1475BV25 are common IO devices, data must not be driven into the device while the outputs are active. The  $\overline{OE}$  can be deasserted HIGH before presenting data to the DQs and DQP<sub>X</sub> inputs. This tri-states the output drivers. As a safety precaution, DQs and DQP<sub>X</sub> are automatically tri-stated during the data portion of a write cycle, regardless of the state of OE.

### Burst Write Accesses

The CY7C1471BV25, CY7C1473BV25, and CY7C1475BV25 have an on-chip burst counter that makes it possible to supply a single address and conduct up to four Write operations without reasserting the address inputs. Drive ADV/LD LOW to load the initial address, as described in the Single Write Access section. When ADV/LD is driven HIGH on the subsequent clock rise, the Chip Enables (CE<sub>1</sub>, CE<sub>2</sub>, and CE<sub>3</sub>) and WE inputs are ignored and the burst counter is incremented. You must drive the correct BW<sub>X</sub> inputs in each cycle of the Burst Write to write the correct data bytes.

### Sleep Mode

The ZZ input pin is an asynchronous input. Asserting ZZ places the SRAM in a power conservation “sleep” mode. Two clock cycles are required to enter into or exit from this “sleep” mode. While in this mode, data integrity is guaranteed. Accesses pending when entering the “sleep” mode are not considered valid nor is the completion of the operation guaranteed. You must select the device before entering the “sleep” mode. CE<sub>1</sub>, CE<sub>2</sub>, and CE<sub>3</sub>, must remain inactive for the duration of t<sub>ZZREC</sub> after the ZZ input returns LOW.

### ZZ Mode Electrical Characteristics

Parameter	Description	Test Conditions	Min	Max	Unit
I <sub>DDZZ</sub>	Sleep mode standby current	ZZ ≥ V <sub>DD</sub> - 0.2V		120	mA
t <sub>ZZS</sub>	Device operation to ZZ	ZZ ≥ V <sub>DD</sub> - 0.2V		2t <sub>CYC</sub>	ns
t <sub>ZZREC</sub>	ZZ recovery time	ZZ ≤ 0.2V	2t <sub>CYC</sub>		ns
t <sub>ZZI</sub>	ZZ active to sleep current	This parameter is sampled		2t <sub>CYC</sub>	ns
t <sub>RZZI</sub>	ZZ Inactive to exit sleep current	This parameter is sampled	0		ns

**Table 2. Interleaved Burst Address Table (MODE = Floating or V<sub>DD</sub>)**

First Address A1: A0	Second Address A1: A0	Third Address A1: A0	Fourth Address A1: A0
00	01	10	11
01	00	11	10
10	11	00	01
11	10	01	00

**Table 3. Linear Burst Address Table (MODE = GND)**

First Address A1: A0	Second Address A1: A0	Third Address A1: A0	Fourth Address A1: A0
00	01	10	11
01	10	11	00
10	11	00	01
11	00	01	10

**Table 4. Truth Table**

The truth table for CY7C1471BV25, CY7C1473BV25, and CY7C1475BV25 follows.<sup>[1, 2, 3, 4, 5, 6, 7]</sup>

Operation	Address Used	$\overline{CE}_1$	$CE_2$	$\overline{CE}_3$	ZZ	ADV/LD	$\overline{WE}$	$\overline{BW}_x$	$\overline{OE}$	$\overline{CEN}$	CLK	DQ
Deselect Cycle	None	H	X	X	L	L	X	X	X	L	L->H	Tri-State
Deselect Cycle	None	X	X	H	L	L	X	X	X	L	L->H	Tri-State
Deselect Cycle	None	X	L	X	L	L	X	X	X	L	L->H	Tri-State
Continue Deselect Cycle	None	X	X	X	L	H	X	X	X	L	L->H	Tri-State
Read Cycle (Begin Burst)	External	L	H	L	L	L	H	X	L	L	L->H	Data Out (Q)
Read Cycle (Continue Burst)	Next	X	X	X	L	H	X	X	L	L	L->H	Data Out (Q)
NOP/Dummy Read (Begin Burst)	External	L	H	L	L	L	H	X	H	L	L->H	Tri-State
Dummy Read (Continue Burst)	Next	X	X	X	L	H	X	X	H	L	L->H	Tri-State
Write Cycle (Begin Burst)	External	L	H	L	L	L	L	L	X	L	L->H	Data In (D)
Write Cycle (Continue Burst)	Next	X	X	X	L	H	X	L	X	L	L->H	Data In (D)
NOP/Write Abort (Begin Burst)	None	L	H	L	L	L	L	H	X	L	L->H	Tri-State
Write Abort (Continue Burst)	Next	X	X	X	L	H	X	H	X	L	L->H	Tri-State
Ignore Clock Edge (Stall)	Current	X	X	X	L	X	X	X	X	H	L->H	-
Sleep Mode	None	X	X	X	H	X	X	X	X	X	X	Tri-State

**Notes**

1. X = "Don't Care." H = Logic HIGH, L = Logic LOW.  $\overline{BW}_x = L$  signifies at least one Byte Write Select is active,  $\overline{BW}_x = Valid$  signifies that the desired Byte Write Selects are asserted, see "Truth Table for Read/Write" on page 12 for details.
2. Write is defined by  $\overline{BW}_x$ , and WE. See "Truth Table for Read/Write" on page 12.
3. When a write cycle is detected, all IOs are tri-stated, even during byte writes.
4. The DQs and  $DQP_x$  pins are controlled by the current cycle and the  $\overline{OE}$  signal.  $\overline{OE}$  is asynchronous and is not sampled with the clock.
5.  $\overline{CEN} = H$ , inserts wait states.
6. Device powers up deselected with the IOs in a tri-state condition, regardless of  $\overline{OE}$ .
7.  $\overline{OE}$  is asynchronous and is not sampled with the clock rise. It is masked internally during write cycles. During a read cycle DQs and  $DQP_x$  = tri-state when  $\overline{OE}$  is inactive or when the device is deselected, and DQs and  $DQP_x$  = data when  $\overline{OE}$  is active.

**Table 5. Truth Table for Read/Write**

The read-write truth table for CY7C1471BV25 follows.<sup>[1, 2, 8]</sup>

Function	$\overline{WE}$	$\overline{BW}_A$	$\overline{BW}_B$	$\overline{BW}_C$	$\overline{BW}_D$
Read	H	X	X	X	X
Write No bytes written	L	H	H	H	H
Write Byte A – (DQ <sub>A</sub> and DQP <sub>A</sub> )	L	L	H	H	H
Write Byte B – (DQ <sub>B</sub> and DQP <sub>B</sub> )	L	H	L	H	H
Write Byte C – (DQ <sub>C</sub> and DQP <sub>C</sub> )	L	H	H	L	H
Write Byte D – (DQ <sub>D</sub> and DQP <sub>D</sub> )	L	H	H	H	L
Write All Bytes	L	L	L	L	L

**Table 6. Truth Table for Read/Write**

The read-write truth table for CY7C1473BV25 follows.<sup>[1, 2, 8]</sup>

Function	$\overline{WE}$	$\overline{BW}_b$	$\overline{BW}_a$
Read	H	X	X
Write – No Bytes Written	L	H	H
Write Byte a – (DQ <sub>a</sub> and DQP <sub>a</sub> )	L	H	L
Write Byte b – (DQ <sub>b</sub> and DQP <sub>b</sub> )	L	L	H
Write Both Bytes	L	L	L

**Table 7. Truth Table for Read/Write**

The read-write truth table for CY7C1475BV25 follows.<sup>[1, 2, 8]</sup>

Function	$\overline{WE}$	$\overline{BW}_x$
Read	H	X
Write – No Bytes Written	L	H
Write Byte X – (DQ <sub>x</sub> and DQP <sub>x</sub> )	L	L
Write All Bytes	L	All $\overline{BW} = L$

**Note**

8. This table is only a partial listing of the byte write combinations. Any combination of  $\overline{BW}_x$  is valid. Appropriate write is based on which byte write is active.

### IEEE 1149.1 Serial Boundary Scan (JTAG)

The CY7C1471BV25, CY7C1473BV25, and CY7C1475BV25 incorporate a serial boundary scan Test Access Port (TAP). This port operates in accordance with IEEE Standard 1149.1-1990 but does not have the set of functions required for full 1149.1 compliance. These functions from the IEEE specification are excluded because their inclusion places an added delay in the critical speed path of the SRAM. Note that the TAP controller functions in a manner that does not conflict with the operation of other devices using 1149.1 fully compliant TAPs. The TAP operates using JEDEC-standard 2.5V IO logic levels.

The CY7C1471BV25, CY7C1473BV25, and CY7C1475BV25 contain a TAP controller, instruction register, boundary scan register, bypass register, and ID register.

### Disabling the JTAG Feature

It is possible to operate the SRAM without using the JTAG feature. To disable the TAP controller, tie TCK LOW ( $V_{SS}$ ) to prevent clocking of the device. TDI and TMS are internally pulled up and may be unconnected. They may alternately be connected to  $V_{DD}$  through a pull up resistor. TDO must be left unconnected. During power up, the device comes up in a reset state, which does not interfere with the operation of the device.

**Figure 3. TAP Controller State Diagram**

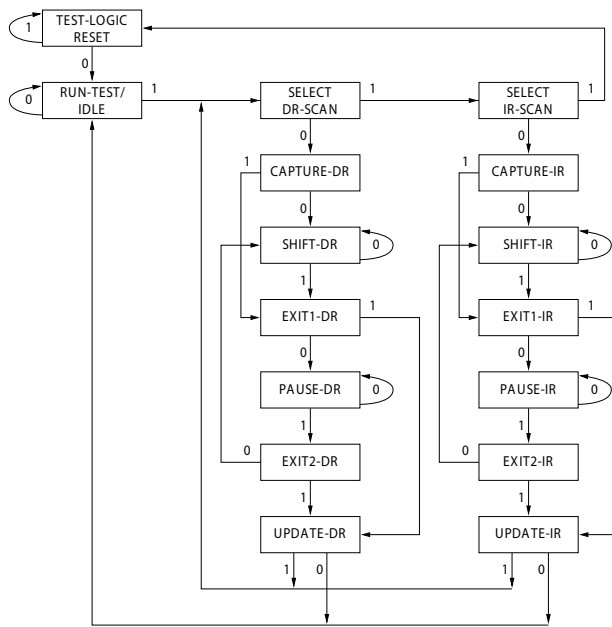

The 0/1 next to each state represents the value of TMS at the rising edge of TCK.

### Test Access Port (TAP)

#### Test Clock (TCK)

The test clock is used only with the TAP controller. All inputs are captured on the rising edge of TCK. All outputs are driven from the falling edge of TCK.

#### Test Mode Select (TMS)

The TMS input gives commands to the TAP controller and is sampled on the rising edge of TCK. You can leave this ball unconnected if the TAP is not used. The ball is pulled up internally, resulting in a logic HIGH level.

#### Test Data In (TDI)

The TDI ball serially inputs information into the registers and is connected to the input of any of the registers. The register between TDI and TDO is chosen by the instruction that is loaded into the TAP instruction register. For information about loading the instruction register, see the [TAP Controller State Diagram](#). TDI is internally pulled up and can be unconnected if the TAP is unused in an application. TDI is connected to the most significant bit (MSB) of any register. (See [TAP Controller Block Diagram](#).)

#### Test Data Out (TDO)

The TDO output ball serially clocks data out from the registers. The output is active depending upon the current state of the TAP state machine. The output changes on the falling edge of TCK. TDO is connected to the least significant bit (LSB) of any register. (See [Tap Controller State Diagram](#).)

**Figure 4. TAP Controller Block Diagram**

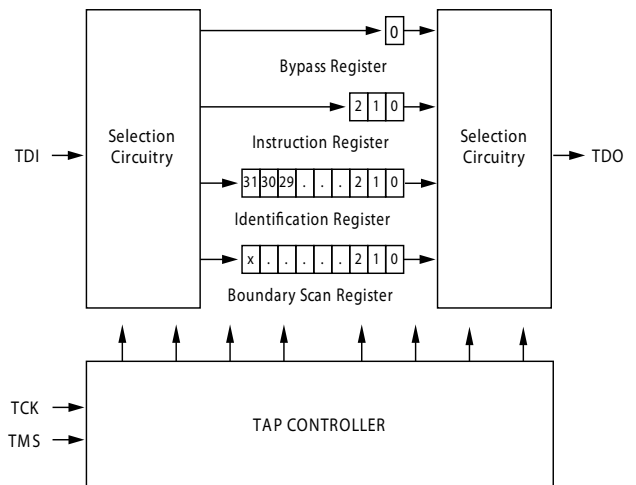

### Performing a TAP Reset

A RESET is performed by forcing TMS HIGH ( $V_{DD}$ ) for five rising edges of TCK. This RESET does not affect the operation of the SRAM and may be performed while the SRAM is operating.

During power up, the TAP is reset internally to ensure that TDO comes up in a High-Z state.

## TAP Registers

Registers are connected between the TDI and TDO balls and enable the scanning of data into and out of the SRAM test circuitry. Only one register is selectable at a time through the instruction register. Data is serially loaded into the TDI ball on the rising edge of TCK. Data is output on the TDO ball on the falling edge of TCK.

### Instruction Register

Three-bit instructions can be serially loaded into the instruction register. This register is loaded when it is placed between the TDI and TDO balls as shown in the [“TAP Controller Block Diagram” on page 13](#). During power up, the instruction register is loaded with the IDCODE instruction. It is also loaded with the IDCODE instruction if the controller is placed in a reset state as described in the previous section.

When the TAP controller is in the Capture-IR state, the two least significant bits are loaded with a binary ‘01’ pattern to enable fault isolation of the board-level serial test data path.

### Bypass Register

To save time when serially shifting data through registers, it is sometimes advantageous to skip certain chips. The bypass register is a single-bit register that can be placed between the TDI and TDO balls. This shifts the data through the SRAM with minimal delay. The bypass register is set LOW ( $V_{SS}$ ) when the BYPASS instruction is executed.

### Boundary Scan Register

The boundary scan register is connected to all the input and bidirectional balls on the SRAM.

The boundary scan register is loaded with the contents of the RAM IO ring when the TAP controller is in the Capture-DR state and is then placed between the TDI and TDO balls when the controller is moved to the Shift-DR state. The EXTEST, SAMPLE/PRELOAD and SAMPLE Z instructions can be used to capture the contents of the IO ring.

The Boundary Scan Order tables show the order in which the bits are connected. Each bit corresponds to one of the bumps on the SRAM package. The MSB of the register is connected to TDI and the LSB is connected to TDO.

### Identification (ID) Register

The ID register is loaded with a vendor specific, 32-bit code during the Capture DR state when the IDCODE command is loaded in the instruction register. The IDCODE is hardwired into the SRAM and can be shifted out when the TAP controller is in the Shift DR state. The ID register has a vendor code and other information described in [“Identification Register Definitions” on page 17](#).

## TAP Instruction Set

### Overview

Eight different instructions are possible with the three-bit instruction register. All combinations are listed in [“Identification Codes” on page 17](#). Three of these instructions are listed as RESERVED and are not for use. The other five instructions are described in this section in detail.

The TAP controller used in this SRAM is not fully compliant to the 1149.1 convention because some of the mandatory 1149.1 instructions are not fully implemented.

You cannot use the TAP controller to load address data or control signals into the SRAM and you cannot preload the IO buffers. The SRAM does not implement the 1149.1 commands EXTEST or INTEST or the PRELOAD portion of SAMPLE/PRELOAD; rather, it performs a capture of the IO ring when these instructions are executed.

Instructions are loaded into the TAP controller during the Shift-IR state when the instruction register is placed between TDI and TDO. During this state, instructions are shifted through the instruction register through the TDI and TDO balls. To execute the instruction after it is shifted in, the TAP controller must be moved into the Update-IR state.

### EXTEST

EXTEST is a mandatory 1149.1 instruction which is executed whenever the instruction register is loaded with all 0s. EXTEST is not implemented in this SRAM TAP controller making this device not compliant with 1149.1. The TAP controller does recognize an all-0 instruction.

When an EXTEST instruction is loaded into the instruction register, the SRAM responds as if a SAMPLE/PRELOAD instruction is loaded. There is one difference between the two instructions. Unlike the SAMPLE/PRELOAD instruction, EXTEST places the SRAM outputs in a High-Z state.

### IDCODE

The IDCODE instruction causes a vendor specific, 32-bit code to load into the instruction register. It also places the instruction register between the TDI and TDO balls and enables the IDCODE for shifting out of the device when the TAP controller enters the Shift-DR state.

The IDCODE instruction is loaded into the instruction register during power up or whenever the TAP controller is in a test logic reset state.

### SAMPLE Z

The SAMPLE Z instruction connects the boundary scan register between the TDI and TDO pins when the TAP controller is in a Shift-DR state. It also places all SRAM outputs into a High-Z state.

### SAMPLE/PRELOAD

SAMPLE/PRELOAD is a 1149.1 mandatory instruction. The PRELOAD portion of this instruction is not implemented, so the device TAP controller is not fully 1149.1 compliant.

When the SAMPLE/PRELOAD instruction is loaded into the instruction register and the TAP controller is in the Capture-DR state, a snapshot of data on the inputs and bidirectional balls is captured in the boundary scan register.

Be aware that the TAP controller clock only operates at a frequency up to 20 MHz, while the SRAM clock operates more than an order of magnitude faster. Because there is a large difference in the clock frequencies, it is possible that, during the Capture-DR state, an input or output may undergo a transition. The TAP may then try to capture a signal while in transition (metastable state). This does not harm the device, but there is



no guarantee as to the value that is captured. Repeatable results may not be possible.

To guarantee that the boundary scan register captures the correct signal value, make certain that the SRAM signal is stabilized long enough to meet the TAP controller's capture setup plus hold time ( $t_{CS}$  plus  $t_{CH}$ ).

The SRAM clock input might not be captured correctly if there is no way in a design to stop (or slow) the clock during a SAMPLE/PRELOAD instruction. If this is an issue, it is still possible to capture all other signals and simply ignore the value of the CLK captured in the boundary scan register.

After the data is captured, it is possible to shift out the data by putting the TAP into the Shift-DR state. This places the boundary scan register between the TDI and TDO balls.

Note that since the PRELOAD part of the command is not implemented, putting the TAP to the Update-DR state while performing a SAMPLE/PRELOAD instruction has the same effect as the Pause-DR command.

**BYPASS**

When the BYPASS instruction is loaded in the instruction register and the TAP is placed in a Shift-DR state, the bypass register is placed between the TDI and TDO balls. The advantage of the BYPASS instruction is that it shortens the boundary scan path when multiple devices are connected together on a board.

**Reserved**

These instructions are not implemented but are reserved for future use. Do not use these instructions.

**Figure 5. TAP Timing**

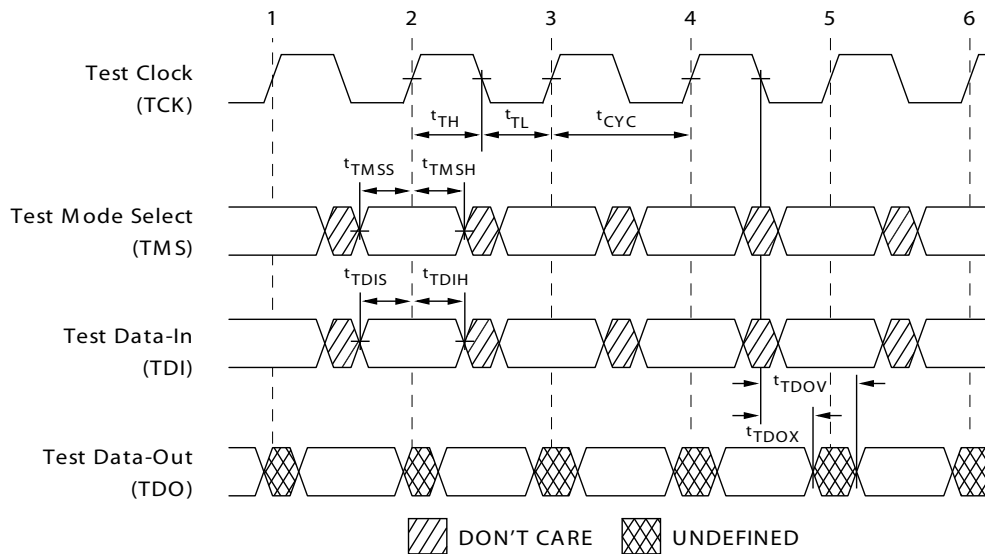

## TAP AC Switching Characteristics

Over the Operating Range<sup>[9, 10]</sup>

Parameter	Description	Min	Max	Unit
<b>Clock</b>				
$t_{TCYC}$	TCK Clock Cycle Time	50		ns
$t_{TF}$	TCK Clock Frequency		20	MHz
$t_{TH}$	TCK Clock HIGH Time	20		ns
$t_{TL}$	TCK Clock LOW Time	20		ns
<b>Output Times</b>				
$t_{TDOV}$	TCK Clock LOW to TDO Valid		10	ns
$t_{TDOX}$	TCK Clock LOW to TDO Invalid	0		ns
<b>Setup Times</b>				
$t_{TMSS}$	TMS Setup to TCK Clock Rise	5		ns
$t_{TDIS}$	TDI Setup to TCK Clock Rise	5		ns
$t_{CS}$	Capture Setup to TCK Rise	5		ns
<b>Hold Times</b>				
$t_{TMSH}$	TMS Hold after TCK Clock Rise	5		ns
$t_{TDIH}$	TDI Hold after Clock Rise	5		ns
$t_{CH}$	Capture Hold after Clock Rise	5		ns

### 2.5V TAP AC Test Conditions

Input pulse levels .....  $V_{SS}$  to 2.5V  
 Input rise and fall time ..... 1 ns  
 Input timing reference levels ..... 1.25V  
 Output reference levels ..... 1.25V  
 Test load termination supply voltage ..... 1.25V

Figure 6. 2.5V TAP AC Output Load Equivalent

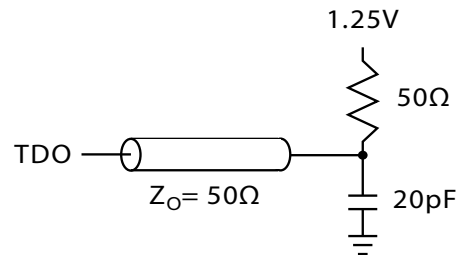

### TAP DC Electrical Characteristics And Operating Conditions

( $0^{\circ}\text{C} < T_A < +70^{\circ}\text{C}$ ;  $V_{DD} = 2.375$  to  $2.625$  unless otherwise noted) <sup>[11]</sup>

Parameter	Description	Test Conditions	Min	Max	Unit
$V_{OH1}$	Output HIGH Voltage	$I_{OH} = -1.0$ mA, $V_{DDQ} = 2.5$ V	2.0		V
$V_{OH2}$	Output HIGH Voltage	$I_{OH} = -100$ $\mu$ A, $V_{DDQ} = 2.5$ V	2.1		V
$V_{OL1}$	Output LOW Voltage	$I_{OL} = 1.0$ mA, $V_{DDQ} = 2.5$ V		0.4	V
$V_{OL2}$	Output LOW Voltage	$I_{OL} = 100$ $\mu$ A, $V_{DDQ} = 2.5$ V		0.2	V
$V_{IH}$	Input HIGH Voltage	$V_{DDQ} = 2.5$ V	1.7	$V_{DD} + 0.3$	V
$V_{IL}$	Input LOW Voltage	$V_{DDQ} = 2.5$ V	-0.3	0.7	V
$I_X$	Input Load Current	$GND \leq V_{IN} \leq V_{DDQ}$	-5	5	$\mu$ A

#### Notes

9.  $t_{CS}$  and  $t_{CH}$  refer to the setup and hold time requirements of latching data from the boundary scan register.

10. Test conditions are specified using the load in TAP AC Test Conditions.  $t_R/t_F = 1$  ns.

11. All voltages refer to  $V_{SS}$  (GND).



**Table 8. Identification Register Definitions**

Instruction Field	CY7C1471BV25 (2MX36)	CY7C1473BV25 (4MX18)	CY7C1475BV25 (1MX72)	Description
Revision Number (31:29)	000	000	000	Describes the version number
Device Depth (28:24)	01011	01011	01011	Reserved for internal use
Architecture/Memory Type(23:18)	001001	001001	001001	Defines memory type and architecture
Bus Width/Density(17:12)	100100	010100	110100	Defines width and density
Cypress JEDEC ID Code (11:1)	00000110100	00000110100	00000110100	Allows unique identification of SRAM vendor
ID Register Presence Indicator (0)	1	1	1	Indicates the presence of an ID register

**Table 9. Scan Register Sizes**

Register Name	Bit Size (x36)	Bit Size (x18)	Bit Size (x72)
Instruction	3	3	3
Bypass	1	1	1
ID	32	32	32
Boundary Scan Order – 165FBGA	71	52	-
Boundary Scan Order – 209BGA	-	-	110

**Table 10. Identification Codes**

Instruction	Code	Description
EXTTEST	000	Captures IO ring contents. Places the boundary scan register between TDI and TDO. Forces all SRAM outputs to High-Z state. This instruction is not 1149.1 compliant.
IDCODE	001	Loads the ID register with the vendor ID code and places the register between TDI and TDO. This operation does not affect SRAM operations.
SAMPLE Z	010	Captures IO ring contents. Places the boundary scan register between TDI and TDO. Forces all SRAM output drivers to a High-Z state.
RESERVED	011	Do Not Use: This instruction is reserved for future use.
SAMPLE/PRELOAD	100	Captures IO ring contents. Places the boundary scan register between TDI and TDO. Does not affect SRAM operation. This instruction does not implement 1149.1 preload function and is therefore not 1149.1 compliant.
RESERVED	101	Do Not Use: This instruction is reserved for future use.
RESERVED	110	Do Not Use: This instruction is reserved for future use.
BYPASS	111	Places the bypass register between TDI and TDO. This operation does not affect SRAM operation.

**Table 11. Boundary Scan Exit Order (2M x 36)**

Bit #	165-Ball ID	Bit #	165-Ball ID	Bit #	165-Ball ID	Bit #	165-Ball ID
1	C1	21	R3	41	J11	61	B7
2	D1	22	P2	42	K10	62	B6
3	E1	23	R4	43	J10	63	A6
4	D2	24	P6	44	H11	64	B5
5	E2	25	R6	45	G11	65	A5
6	F1	26	R8	46	F11	66	A4
7	G1	27	P3	47	E11	67	B4
8	F2	28	P4	48	D10	68	B3
9	G2	29	P8	49	D11	69	A3
10	J1	30	P9	50	C11	70	A2
11	K1	31	P10	51	G10	71	B2
12	L1	32	R9	52	F10		
13	J2	33	R10	53	E10		
14	M1	34	R11	54	A9		
15	N1	35	N11	55	B9		
16	K2	36	M11	56	A10		
17	L2	37	L11	57	B10		
18	M2	38	M10	58	A8		
19	R1	39	L10	59	B8		
20	R2	40	K11	60	A7		

**Table 12. Boundary Scan Exit Order (4M x 18)**

Bit #	165-Ball ID	Bit #	165-Ball ID	Bit #	165-Ball ID	Bit #	165-Ball ID
1	D2	14	R4	27	L10	40	B10
2	E2	15	P6	28	K10	41	A8
3	F2	16	R6	29	J10	42	B8
4	G2	17	R8	30	H11	43	A7
5	J1	18	P3	31	G11	44	B7
6	K1	19	P4	32	F11	45	B6
7	L1	20	P8	33	E11	46	A6
8	M1	21	P9	34	D11	47	B5
9	N1	22	P10	35	C11	48	A4
10	R1	23	R9	36	A11	49	B3
11	R2	24	R10	37	A9	50	A3
12	R3	25	R11	38	B9	51	A2
13	P2	26	M10	39	A10	52	B2

**Table 13. Boundary Scan Exit Order (1M x 72)**

Bit #	209-Ball ID	Bit #	209-Ball ID	Bit #	209-Ball ID	Bit #	209-Ball ID
1	A1	29	T1	57	U10	85	B11
2	A2	30	T2	58	T11	86	B10
3	B1	31	U1	59	T10	87	A11
4	B2	32	U2	60	R11	88	A10
5	C1	33	V1	61	R10	89	A7
6	C2	34	V2	62	P11	90	A5
7	D1	35	W1	63	P10	91	A9
8	D2	36	W2	64	N11	92	U8
9	E1	37	T6	65	N10	93	A6
10	E2	38	V3	66	M11	94	D6
11	F1	39	V4	67	M10	95	K6
12	F2	40	U4	68	L11	96	B6
13	G1	41	W5	69	L10	97	K3
14	G2	42	V6	70	P6	98	A8
15	H1	43	W6	71	J11	99	B4
16	H2	44	V5	72	J10	100	B3
17	J1	45	U5	73	H11	101	C3
18	J2	46	U6	74	H10	102	C4
19	L1	47	W7	75	G11	103	C8
20	L2	48	V7	76	G10	104	C9
21	M1	49	U7	77	F11	105	B9
22	M2	50	V8	78	F10	106	B8
23	N1	51	V9	79	E10	107	A4
24	N2	52	W11	80	E11	108	C6
25	P1	53	W10	81	D11	109	B7
26	P2	54	V11	82	D10	110	A3
27	R2	55	V10	83	C11		
28	R1	56	U11	84	C10		

## Maximum Ratings

Exceeding maximum ratings may impair the useful life of the device. These user guidelines are not tested.

Storage Temperature ..... -65°C to +150°C  
 Ambient Temperature with  
 Power Applied ..... -55°C to +125°C  
 Supply Voltage on V<sub>DD</sub> Relative to GND ..... -0.5V to +3.6V  
 Supply Voltage on V<sub>DDQ</sub> Relative to GND ..... -0.5V to +V<sub>DD</sub>  
 DC Voltage Applied to Outputs  
 in Tri-State ..... -0.5V to V<sub>DDQ</sub> + 0.5V

DC Input Voltage ..... -0.5V to V<sub>DD</sub> + 0.5V  
 Current into Outputs (LOW) ..... 20 mA  
 Static Discharge Voltage ..... >2001V  
 (MIL-STD-883, Method 3015)  
 Latch Up Current ..... >200 mA

## Operating Range

Range	Ambient Temperature	V <sub>DD</sub>	V <sub>DDQ</sub>
Commercial	0°C to +70°C	2.5V -5%/+5%	2.5V -5% to V <sub>DD</sub>
Industrial	-40°C to +85°C		

## Electrical Characteristics

Over the Operating Range <sup>[12, 13]</sup>

Parameter	Description	Test Conditions	Min	Max	Unit
V <sub>DD</sub>	Power Supply Voltage		2.375	2.625	V
V <sub>DDQ</sub>	IO Supply Voltage	For 2.5V IO	2.375	V <sub>DD</sub>	V
V <sub>OH</sub>	Output HIGH Voltage	For 2.5V IO, I <sub>OH</sub> = -1.0 mA	2.0		V
V <sub>OL</sub>	Output LOW Voltage	For 2.5V IO, I <sub>OL</sub> = 1.0 mA		0.4	V
V <sub>IH</sub>	Input HIGH Voltage <sup>[12]</sup>	For 2.5V IO	1.7	V <sub>DD</sub> + 0.3V	V
V <sub>IL</sub>	Input LOW Voltage <sup>[12]</sup>	For 2.5V IO	-0.3	0.7	V
I <sub>X</sub>	Input Leakage Current except ZZ and MODE	GND ≤ V <sub>I</sub> ≤ V <sub>DDQ</sub>	-5	5	μA
	Input Current of MODE	Input = V <sub>SS</sub>	-30		μA
		Input = V <sub>DD</sub>		5	μA
	Input Current of ZZ	Input = V <sub>SS</sub>	-5		μA
Input = V <sub>DD</sub>			30	μA	
I <sub>OZ</sub>	Output Leakage Current	GND ≤ V <sub>I</sub> ≤ V <sub>DDQ</sub> , Output Disabled	-5	5	μA
I <sub>DD</sub> <sup>[14]</sup>	V <sub>DD</sub> Operating Supply Current	V <sub>DD</sub> = Max, I <sub>OUT</sub> = 0 mA, f = f <sub>MAX</sub> = 1/t <sub>CYC</sub>	6.5 ns cycle, 133 MHz	305	mA
			8.5 ns cycle, 100 MHz	275	mA
I <sub>SB1</sub>	Automatic CE Power Down Current—TTL Inputs	V <sub>DD</sub> = Max, Device Deselected, V <sub>IN</sub> ≥ V <sub>IH</sub> or V <sub>IN</sub> ≤ V <sub>IL</sub> , f = f <sub>MAX</sub> , inputs switching	6.5 ns cycle, 133 MHz	170	mA
			8.5 ns cycle, 100 MHz	170	mA
I <sub>SB2</sub>	Automatic CE Power Down Current—CMOS Inputs	V <sub>DD</sub> = Max, Device Deselected, V <sub>IN</sub> ≤ 0.3V or V <sub>IN</sub> ≥ V <sub>DD</sub> - 0.3V, f = 0, inputs static		120	mA
I <sub>SB3</sub>	Automatic CE Power Down Current—CMOS Inputs	V <sub>DD</sub> = Max, Device Deselected, or V <sub>IN</sub> ≤ 0.3V or V <sub>IN</sub> ≥ V <sub>DDQ</sub> - 0.3V, f = f <sub>MAX</sub> , inputs switching	6.5 ns cycle, 133 MHz	170	mA
			8.5 ns cycle, 100 MHz	170	mA
I <sub>SB4</sub>	Automatic CE Power Down Current—TTL Inputs	V <sub>DD</sub> = Max, Device Deselected, V <sub>IN</sub> ≥ V <sub>DD</sub> - 0.3V or V <sub>IN</sub> ≤ 0.3V, f = 0, inputs static		135	mA

### Notes

12. Overshoot: V<sub>IH</sub>(AC) < V<sub>DD</sub> + 1.5V (pulse width less than t<sub>CYC</sub>/2). Undershoot: V<sub>IL</sub>(AC) > -2V (pulse width less than t<sub>CYC</sub>/2).
13. T<sub>Power-up</sub>: assumes a linear ramp from 0V to V<sub>DD</sub>(min.) within 200 ms. During this time V<sub>IH</sub> < V<sub>DD</sub> and V<sub>DDQ</sub> ≤ V<sub>DD</sub>.
14. The operation current is calculated with 50% read cycle and 50% write cycle.

## Capacitance

Tested initially and after any design or process change that may affect these parameters.

Parameter	Description	Test Conditions	100 TQFP Max	165 FBGA Max	209 FBGA Max	Unit
C <sub>ADDRESS</sub>	Address Input Capacitance	T <sub>A</sub> = 25°C, f = 1 MHz, V <sub>DD</sub> = 2.5V V <sub>DDQ</sub> = 2.5V	6	6	6	pF
C <sub>DATA</sub>	Data Input Capacitance		5	5	5	pF
C <sub>CTRL</sub>	Control Input Capacitance		8	8	8	pF
C <sub>CLK</sub>	Clock Input Capacitance		6	6	6	pF
C <sub>IO</sub>	Input-Output Capacitance		5	5	5	pF

## Thermal Resistance

Tested initially and after any design or process change that may affect these parameters.

Parameter	Description	Test Conditions	100 TQFP Package	165 FBGA Package	209 FBGA Package	Unit
Θ <sub>JA</sub>	Thermal Resistance (Junction to Ambient)	Test conditions follow standard test methods and procedures for measuring thermal impedance, according to EIA/JESD51.	24.63	16.3	15.2	°C/W
Θ <sub>JC</sub>	Thermal Resistance (Junction to Case)		2.28	2.1	1.7	°C/W

Figure 7. AC Test Loads and Waveforms

### 2.5V IO Test Load

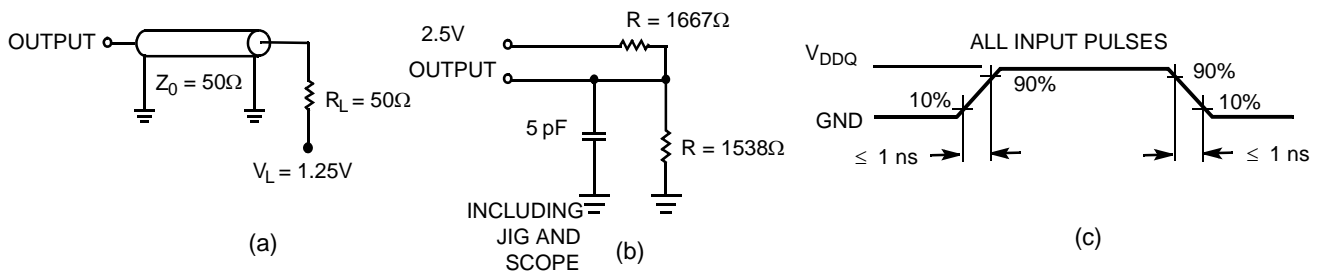

## Switching Characteristics

Over the Operating Range. Timing reference level is 1.25V when  $V_{DDQ} = 2.5V$ . Test conditions shown in (a) of “AC Test Loads and Waveforms” on page 21 unless otherwise noted.

Parameter	Description	133 MHz		100 MHz		Unit
		Min	Max	Min	Max	
$t_{POWER}$		1		1		ms
<b>Clock</b>						
$t_{CYC}$	Clock Cycle Time	7.5		10		ns
$t_{CH}$	Clock HIGH	2.5		3.0		ns
$t_{CL}$	Clock LOW	2.5		3.0		ns
<b>Output Times</b>						
$t_{CDV}$	Data Output Valid After CLK Rise		6.5		8.5	ns
$t_{DOH}$	Data Output Hold After CLK Rise	2.5		2.5		ns
$t_{CLZ}$	Clock to Low-Z [16, 17, 18]	3.0		3.0		ns
$t_{CHZ}$	Clock to High-Z [16, 17, 18]		3.8		4.5	ns
$t_{OEV}$	$\overline{OE}$ LOW to Output Valid		3.0		3.8	ns
$t_{OELZ}$	$\overline{OE}$ LOW to Output Low-Z [16, 17, 18]	0		0		ns
$t_{OEZH}$	$\overline{OE}$ HIGH to Output High-Z [16, 17, 18]		3.0		4.0	ns
<b>Setup Times</b>						
$t_{AS}$	Address Setup Before CLK Rise	1.5		1.5		ns
$t_{ALS}$	ADV/LD Setup Before CLK Rise	1.5		1.5		ns
$t_{WES}$	$\overline{WE}$ , $\overline{BW}_X$ Setup Before CLK Rise	1.5		1.5		ns
$t_{CENS}$	$\overline{CEN}$ Setup Before CLK Rise	1.5		1.5		ns
$t_{DS}$	Data Input Setup Before CLK Rise	1.5		1.5		ns
$t_{CES}$	Chip Enable Setup Before CLK Rise	1.5		1.5		ns
<b>Hold Times</b>						
$t_{AH}$	Address Hold After CLK Rise	0.5		0.5		ns
$t_{ALH}$	ADV/LD Hold After CLK Rise	0.5		0.5		ns
$t_{WEH}$	$\overline{WE}$ , $\overline{BW}_X$ Hold After CLK Rise	0.5		0.5		ns
$t_{CENH}$	$\overline{CEN}$ Hold After CLK Rise	0.5		0.5		ns
$t_{DH}$	Data Input Hold After CLK Rise	0.5		0.5		ns
$t_{CEH}$	Chip Enable Hold After CLK Rise	0.5		0.5		ns

### Notes

15. This part has a voltage regulator internally;  $t_{POWER}$  is the time that the power is supplied above  $V_{DD}$ (minimum) initially, before a read or write operation can be initiated.
16.  $t_{CHZ}$ ,  $t_{CLZ}$ ,  $t_{OELZ}$ , and  $t_{OEZH}$  are specified with AC test conditions shown in part (b) of “AC Test Loads and Waveforms” on page 21. Transition is measured  $\pm 200$  mV from steady-state voltage.
17. At any supplied voltage and temperature,  $t_{OEZH}$  is less than  $t_{OELZ}$  and  $t_{CHZ}$  is less than  $t_{CLZ}$  to eliminate bus contention between SRAMs when sharing the same data bus. These specifications do not imply a bus contention condition, but reflect parameters guaranteed over worst case user conditions. Device is designed to achieve High-Z before Low-Z under the same system conditions.
18. This parameter is sampled and not 100% tested.

## Switching Waveforms

Figure 8 shows read-write timing waveform.<sup>[19, 20, 21]</sup>

Figure 8. Read/Write Timing

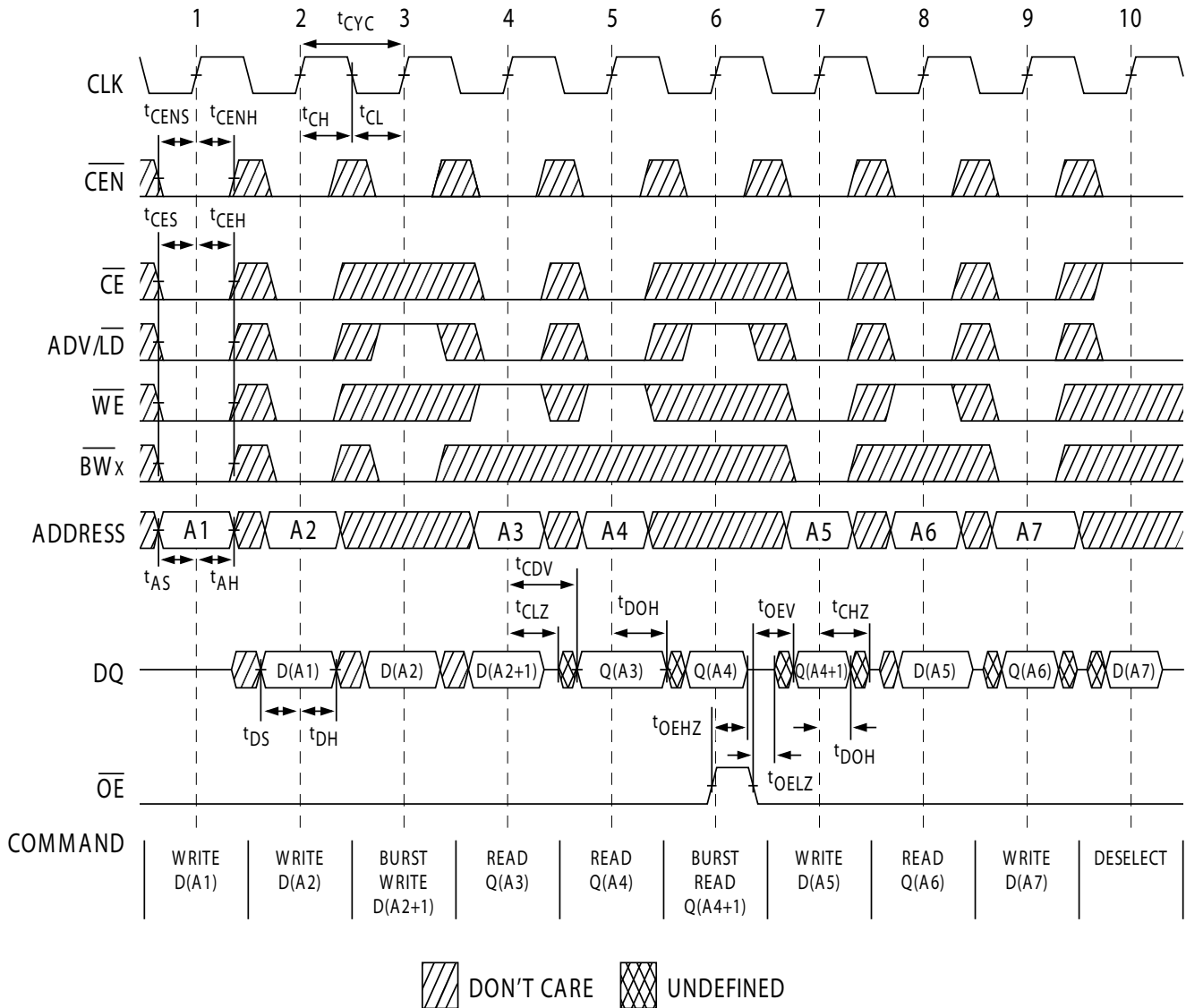

### Notes

19. For this waveform ZZ is tied LOW.

20. When  $\overline{CE}$  is LOW,  $\overline{CE}_1$  is LOW,  $CE_2$  is HIGH, and  $\overline{CE}_3$  is LOW. When  $\overline{CE}$  is HIGH,  $\overline{CE}_1$  is HIGH,  $CE_2$  is LOW or  $\overline{CE}_3$  is HIGH.

21. Order of the Burst sequence is determined by the status of the MODE (0 = Linear, 1 = Interleaved). Burst operations are optional.

**Switching Waveforms** (continued)

Figure 9 shows NOP, STALL and DESELECT Cycles waveform.<sup>[19, 20, 22]</sup>

**Figure 9. NOP, STALL and DESELECT Cycles**

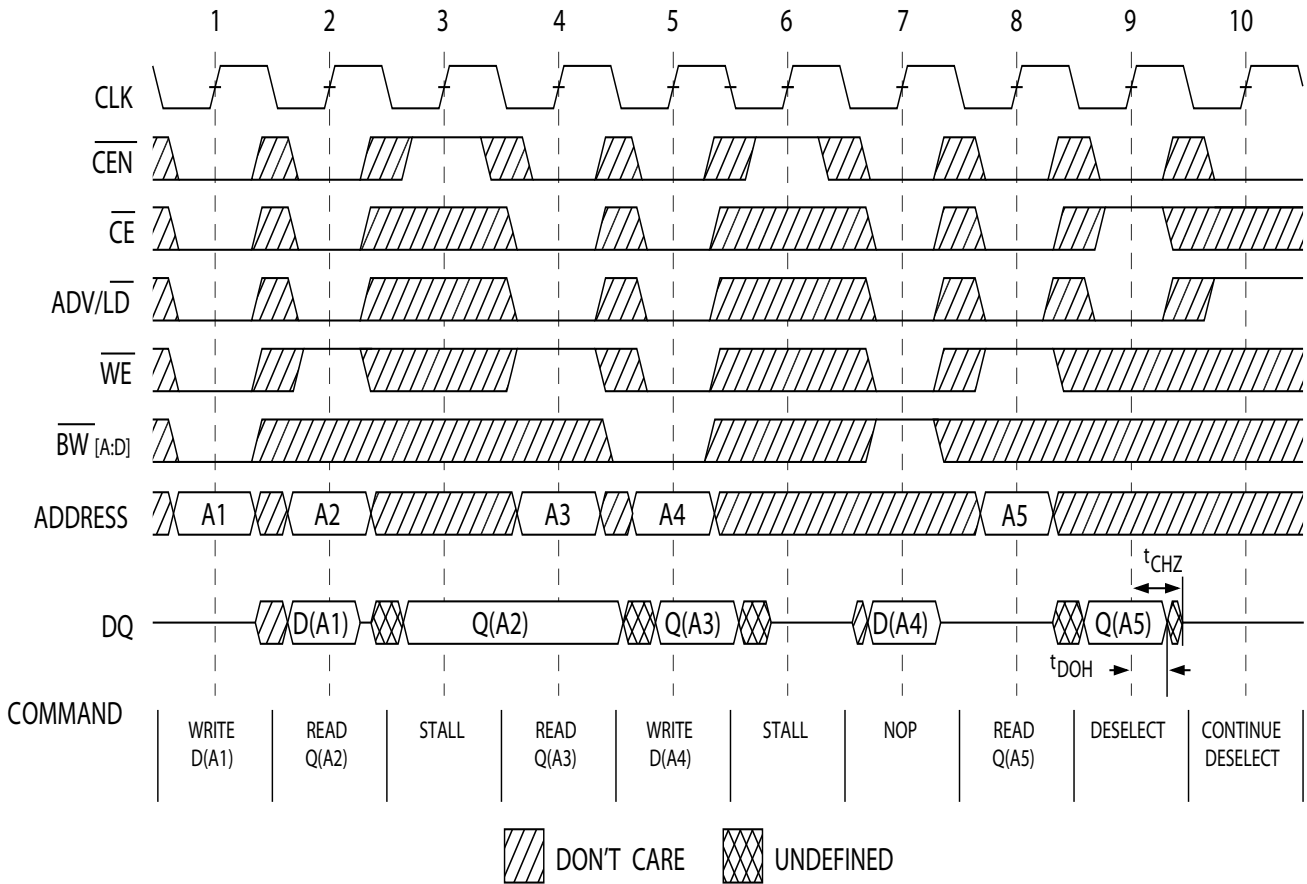

**Note**

22. The IGNORE CLOCK EDGE or STALL cycle (Clock 3) illustrates  $\overline{CEN}$  being used to create a pause. A write is not performed during this cycle.



Switching Waveforms (continued)

Figure 10 shows ZZ Mode timing waveform.<sup>[23, 24]</sup>

Figure 10. ZZ Mode Timing

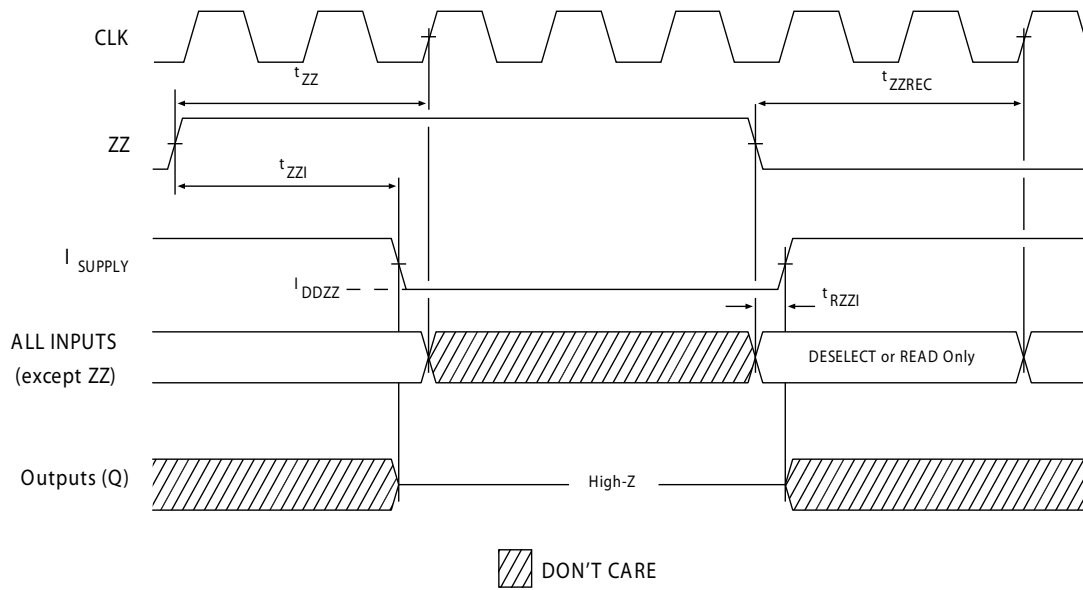

Notes

- 23. Device must be deselected when entering ZZ mode. See "Truth Table" on page 11 for all possible signal conditions to deselect the device.
- 24. DQs are in high-Z when exiting ZZ sleep mode.

## Ordering Information

Not all of the speed, package and temperature ranges are available. Please contact your local sales representative or visit [www.cypress.com](http://www.cypress.com) for actual products offered.

Speed (MHz)	Ordering Code	Package Diagram	Part and Package Type	Operating Range	
133	CY7C1471BV25-133AXC	51-85050	100-pin Thin Quad Flat Pack (14 x 20 x 1.4 mm) Pb-Free	Commercial	
	CY7C1473BV25-133AXC				
	CY7C1471BV25-133BZC	51-85165	165-ball Fine-Pitch Ball Grid Array (15 x 17 x 1.4 mm)		
	CY7C1473BV25-133BZC				
	CY7C1471BV25-133BZXC	51-85165	165-ball Fine-Pitch Ball Grid Array (15 x 17 x 1.4 mm) Pb-Free		
	CY7C1473BV25-133BZXC				
	CY7C1475BV25-133BGC	51-85167	209-ball Fine-Pitch Ball Grid Array (14 x 22 x 1.76 mm)		
	CY7C1475BV25-133BGXC		209-ball Fine-Pitch Ball Grid Array (14 x 22 x 1.76 mm) Pb-Free		
	CY7C1471BV25-133AXI	51-85050	100-pin Thin Quad Flat Pack (14 x 20 x 1.4 mm) Pb-Free		Industrial
	CY7C1473BV25-133AXI				
	CY7C1471BV25-133BZI	51-85165	165-ball Fine-Pitch Ball Grid Array (15 x 17 x 1.4 mm)		
	CY7C1473BV25-133BZI				
	CY7C1471BV25-133BZXI	51-85165	165-ball Fine-Pitch Ball Grid Array (15 x 17 x 1.4 mm) Pb-Free		
	CY7C1473BV25-133BZXI				
CY7C1475BV25-133BGI	51-85167	209-ball Fine-Pitch Ball Grid Array (14 x 22 x 1.76 mm)			
CY7C1475BV25-133BGXI		209-ball Fine-Pitch Ball Grid Array (14 x 22 x 1.76 mm) Pb-Free			
100	CY7C1471BV25-100AXC	51-85050	100-pin Thin Quad Flat Pack (14 x 20 x 1.4 mm) Pb-Free	Commercial	
	CY7C1473BV25-100AXC				
	CY7C1471BV25-100BZC	51-85165	165-ball Fine-Pitch Ball Grid Array (15 x 17 x 1.4 mm)		
	CY7C1473BV25-100BZC				
	CY7C1471BV25-100BZXC	51-85165	165-ball Fine-Pitch Ball Grid Array (15 x 17 x 1.4 mm) Pb-Free		
	CY7C1473BV25-100BZXC				
	CY7C1475BV25-100BGC	51-85167	209-ball Fine-Pitch Ball Grid Array (14 x 22 x 1.76 mm)		
	CY7C1475BV25-100BGXC		209-ball Fine-Pitch Ball Grid Array (14 x 22 x 1.76 mm) Pb-Free		
	CY7C1471BV25-100AXI	51-85050	100-pin Thin Quad Flat Pack (14 x 20 x 1.4 mm) Pb-Free		Industrial
	CY7C1473BV25-100AXI				
	CY7C1471BV25-100BZI	51-85165	165-ball Fine-Pitch Ball Grid Array (15 x 17 x 1.4 mm)		
	CY7C1473BV25-100BZI				
	CY7C1471BV25-100BZXI	51-85165	165-ball Fine-Pitch Ball Grid Array (15 x 17 x 1.4 mm) Pb-Free		
	CY7C1473BV25-100BZXI				
	CY7C1475BV25-100BGI	51-85167	209-ball Fine-Pitch Ball Grid Array (14 x 22 x 1.76 mm)		
	CY7C1475BV25-100BGXI		209-ball Fine-Pitch Ball Grid Array (14 x 22 x 1.76 mm) Pb-Free		

Package Diagrams

Figure 11. 100-Pin Thin Plastic Quad Flatpack (14 x 20 x 1.4 mm), 51-85050

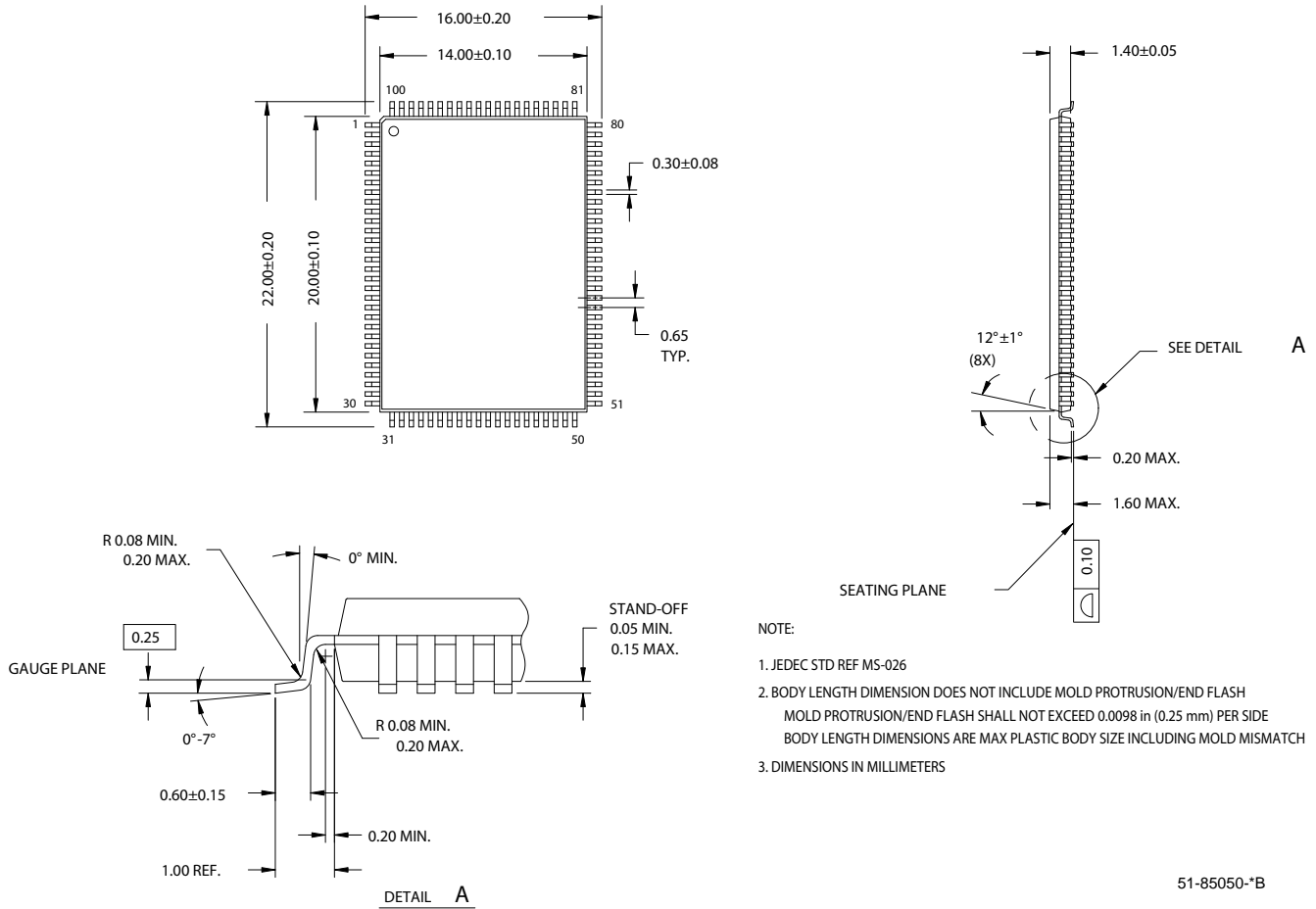

51-85050-\*B

**Package Diagrams** (continued)

**Figure 12. 165-Ball FBGA (15 x 17 x 1.4 mm), 51-85165**

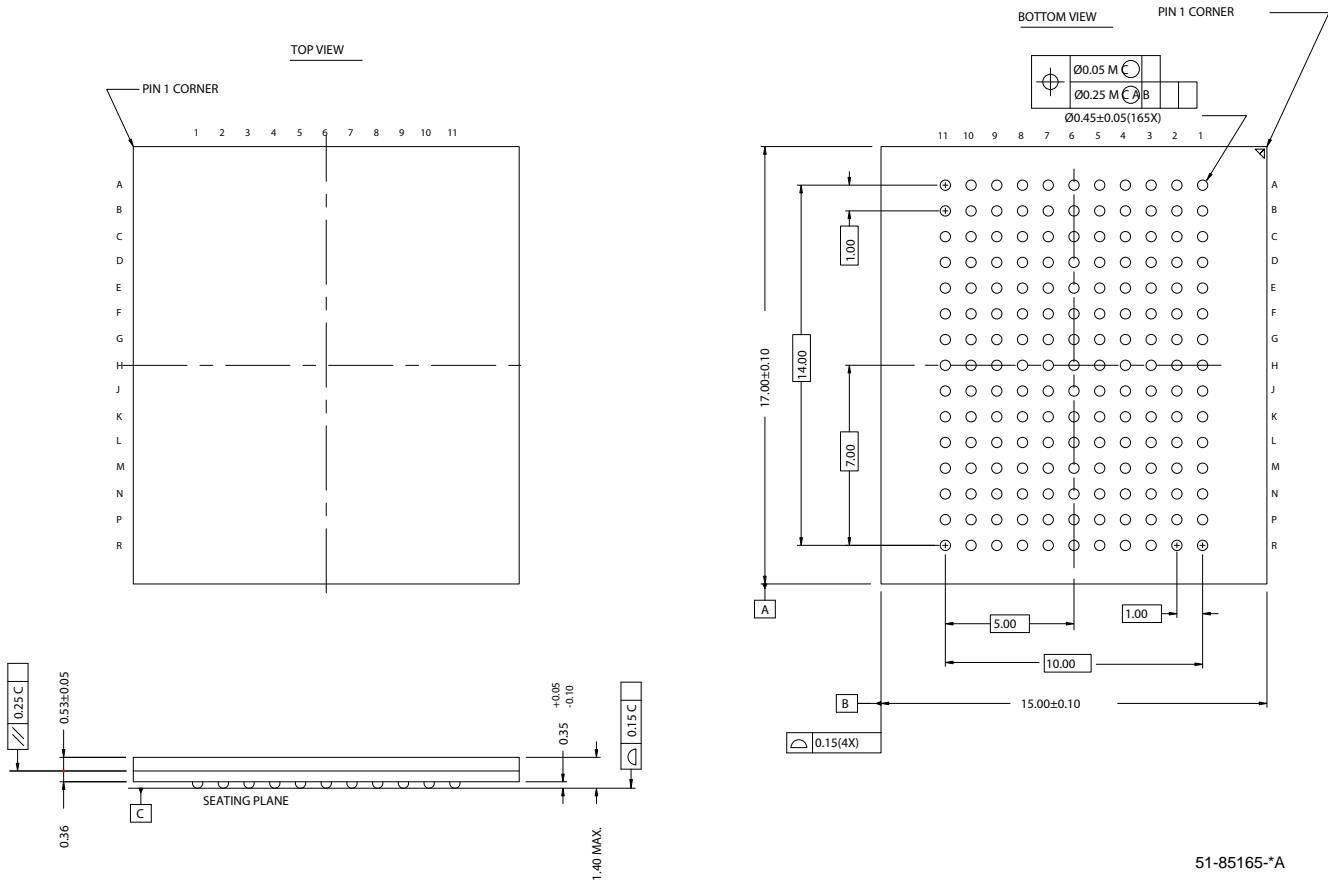

51-85165-A

**Package Diagrams** (continued)

**Figure 13. 209-Ball FBGA (14 x 22 x 1.76 mm), 51-85167**

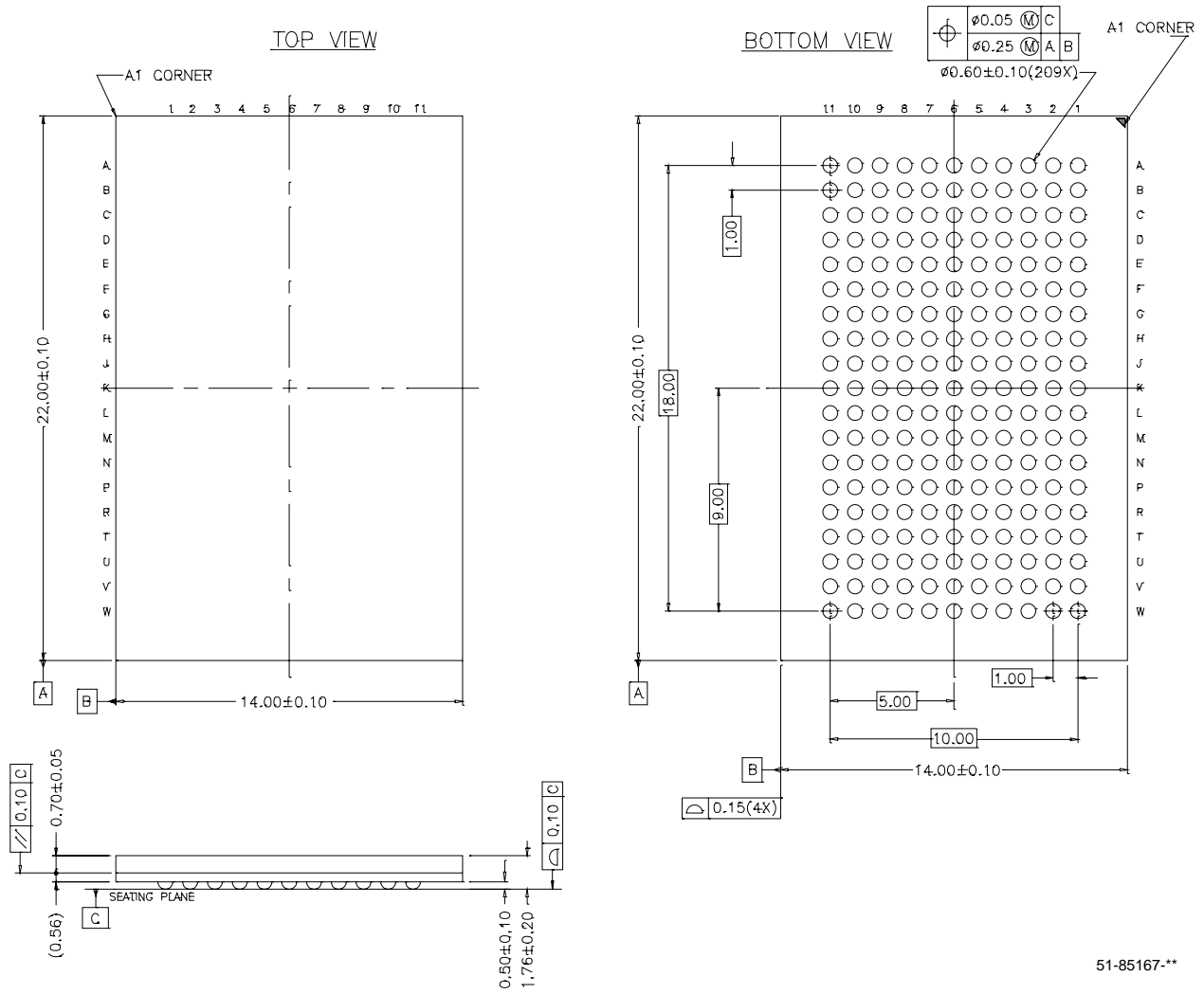

51-85167-\*\*

## Document History Page

**Document Title: CY7C1471BV25/CY7C1473BV25/CY7C1475BV25, 72-Mbit (2M x 36/4M x 18/1M x 72)  
Flow-Through SRAM with NoBL™ Architecture  
Document Number: 001-15013**

REV.	ECN NO.	Issue Date	Orig. of Change	Description of Change
**	1024500	See ECN	VKN/KK/TMP	New Data Sheet
*A	1274731	See ECN	VKN/AESA	Corrected typo in the "NOP, STALL and DESELECT Cycles" waveform
*B	1562503	See ECN	VKN/AESA	Removed 1.8V IO offering from the data sheet
*C	1897447	See ECN	VKN/AESA	Added footnote 14 related to IDD
*D	2082487	See ECN	VKN	Converted from preliminary to final
*E	2159486	See ECN	VKN/PYRS	Minor Change-Moved to the external web

© Cypress Semiconductor Corporation, 2007-2008. The information contained herein is subject to change without notice. Cypress Semiconductor Corporation assumes no responsibility for the use of any circuitry other than circuitry embodied in a Cypress product. Nor does it convey or imply any license under patent or other rights. Cypress products are not warranted nor intended to be used for medical, life support, life saving, critical control or safety applications, unless pursuant to an express written agreement with Cypress. Furthermore, Cypress does not authorize its products for use as critical components in life-support systems where a malfunction or failure may reasonably be expected to result in significant injury to the user. The inclusion of Cypress products in life-support systems application implies that the manufacturer assumes all risk of such use and in doing so indemnifies Cypress against all charges.

Any Source Code (software and/or firmware) is owned by Cypress Semiconductor Corporation (Cypress) and is protected by and subject to worldwide patent protection (United States and foreign), United States copyright laws and international treaty provisions. Cypress hereby grants to licensee a personal, non-exclusive, non-transferable license to copy, use, modify, create derivative works of, and compile the Cypress Source Code and derivative works for the sole purpose of creating custom software and or firmware in support of licensee product to be used only in conjunction with a Cypress integrated circuit as specified in the applicable agreement. Any reproduction, modification, translation, compilation, or representation of this Source Code except as specified above is prohibited without the express written permission of Cypress.

Disclaimer: CYPRESS MAKES NO WARRANTY OF ANY KIND, EXPRESS OR IMPLIED, WITH REGARD TO THIS MATERIAL, INCLUDING, BUT NOT LIMITED TO, THE IMPLIED WARRANTIES OF MERCHANTABILITY AND FITNESS FOR A PARTICULAR PURPOSE. Cypress reserves the right to make changes without further notice to the materials described herein. Cypress does not assume any liability arising out of the application or use of any product or circuit described herein. Cypress does not authorize its products for use as critical components in life-support systems where a malfunction or failure may reasonably be expected to result in significant injury to the user. The inclusion of Cypress' product in a life-support systems application implies that the manufacturer assumes all risk of such use and in doing so indemnifies Cypress against all charges.

Use may be limited by and subject to the applicable Cypress software license agreement.