

**Rail-to-Rail I/O, High-Slew-Rate OP Amp****Features**

- +3V to +5.5V Single-Supply Operation
- Input / Output Rail-to-Rail
- Low input current
- High output driving capacity
- Low Quiescent Current: 500 μ A @ 5V
- High Slew rate 6.5V/ μ s
- High Gain-Bandwidth Product 6.5MHz
- High Open Loop Gain 95dB
- High PSRR 70dB

Applications

- Headphone Driver
- Portable Equipment
- Battery-Powered Equipment
- Multimedia Audio
- ASIC Input or Output Amplifier
- Sensor Amplifier
- Low Power/Low Voltage Applications

General Description

G1214 is a input/output rail-to-rail Operational Amplifier. It can be operated from +3V to +5.5V single supply or from $\pm 1.5V$ to $\pm 2.75V$ dual supply. G1214 can drive 66mA into resistor loads to within 10% power rail. AC performance is very excellent with 6.5MHz bandwidth, 6.5V/ μ s Slew Rate, 95dB open loop gain, 60 degree phase margin and low distortion.

Supply current of G1214 is only 500 μ A per Amplifier. It is very suitable for low current consumption applications to control high current loads. Applications include audio amplification for computers, sound ports, sound cards and set-top boxes.

G1214 is housed in a 5-pin small SOT-23-5 and SC-70-5 package.

Ordering Information

ORDER NUMBER	ORDER NUMBER (Pb free)	MARKING	TEMP. RANGE	PACKAGE
G1214T1U	G1214T1Uf	1214x	-40°C to 85°C	SOT-23-5
G1214TAU	G1214TAUf	1214x	-40°C to 85°C	SC-70-5
G1214T12U	G1214T12Uf	214Ax	-40°C to 85°C	SOT-23-5
G1214TA2U	G1214TA2Uf	14xx	-40°C to 85°C	SC-70-5

Note:T1: SOT-23-5 TA: SC-70-5

2: Bonding Code

U: Tape & Reel

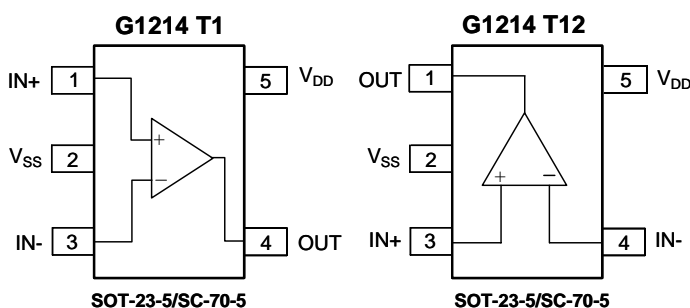
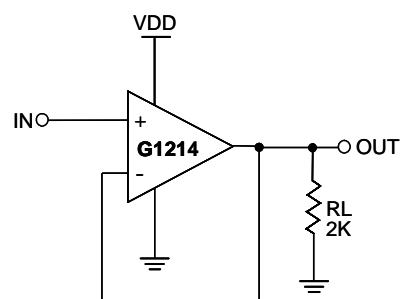
Pin Configuration**Typical Application Circuit**

Rail-to-Rail is a registered trademark of Nippon Motorola, Ltd.

Absolute Maximum Ratings

Supply Voltage (V_{DD} to V_{SS}) 6.5V
 All Other Pins ($V_{SS}-0.3V$) to ($V_{DD}+0.3V$)
 Continuous Power Dissipation ($T_A=25^\circ C$)
 SOT-23-5 520mW
 SC-70-5 313mW
 Thermal Resistance Junction to Ambient, (θ_{JA})
 SOT-23-5 240°C/Watt
 SC-70-5 400°C/Watt

Junction Temperature 150°C
 Operating Temperature Range -40°C to 85°C
 Storage Temperature Range -65°C to 160°C
 Reflow Temperature (soldering, 10sec) 260°C

Electrical Characteristics

$V_{DD} = 5V$; $V_{SS} = 0V$; $T_{amb} = 25^\circ C$; $C_L = 10pF$, $R_L = 1k\Omega$ to $V_{DD}/2$; unless otherwise specified.

PARAMETER	SYMBOL	CONDITION	MIN	TYP	MAX	UNIT
Supplies						
Supply Voltage Range	V_{DD}	Note1	3	---	5.5	V
Supply Current	I_{DD}	No load	---	0.5	0.7	mA
Total Power Dissipation	P_{tot}	No load	---	0.25	0.35	mW
DC Characteristics						
Input Offset Voltage	$V_{I(OS)}$		---	± 5	± 15	mV
Common Mode Voltage	V_{CM}	Inferred from CMRR test	0	---	5	V
Input Bias Current	I_B		---	± 1.5	± 20	nA
Input Bias Current Offset	I_{OS}		---	± 1.5	± 20	nA
Input Resistance	R_{IN}		---	1000	---	M Ω
Open Loop Gain	A_V		85	95	---	dB
Maximum Output Current	I_O	$V_{OUT} = \pm V_{IN} \times 90\%$	55	± 66	---	mA
Output Voltage Swing High	V_{OH}	$R_L = 2k\Omega$	4.96	4.99	---	V
Output Voltage Swing Low	V_{OL}	$R_L = 2k\Omega$	-	0.012	0.04	V
Power Supply Rejection Ratio	PSRR	$3V \leq V_{DD} \leq 5.5V$	45	70	---	dB
Common-Mode Rejection Ratio	CMRR	$V_{SS} \leq V_{CM} \leq V_{DD}$	45	65	---	dB
AC Characteristics						
Gain-Bandwidth Product	GBWP	Open-loop; No Load	---	6.5	---	MHz
Slew-Rate	SR	Measured from 10% to 90% of 4V _{P-P} step, $R_L = 1k\Omega$, $C_L = 10pF$	---	6.5	---	V/ μs
Phase Margin	PM		---	60	---	deg
Maximum Output Current with THD	I_O	THD<0.1%, $R_L = 16\Omega$	---	100	---	mA

Note1: Guaranteed by the Power-Supply Rejection Ratio (PSRR) test

Typical Performance Characteristics

$V_{DD} = 5V$; $V_{SS} = 0V$; $T_{amb} = 25^{\circ}C$; $C_L = 10pF$, $R_L = 1k\Omega$ to $V_{DD}/2$; unless otherwise specified.

Open Loop Gain & Phase Margin vs. Frequency

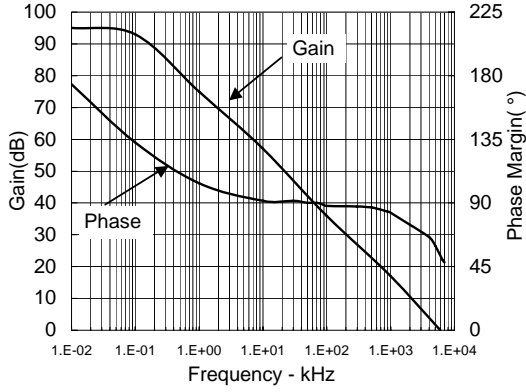

PSRR vs. Frequency

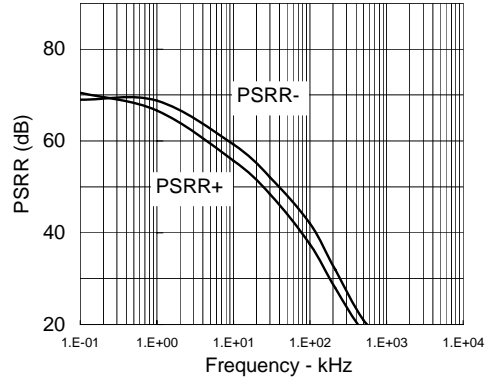

CMRR vs. Frequency

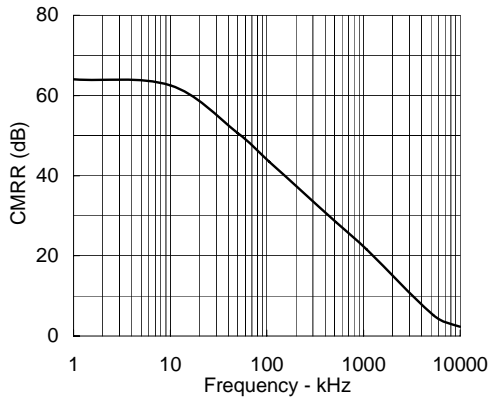

Total Harmonic Distortion Plus Noise vs. Output Power

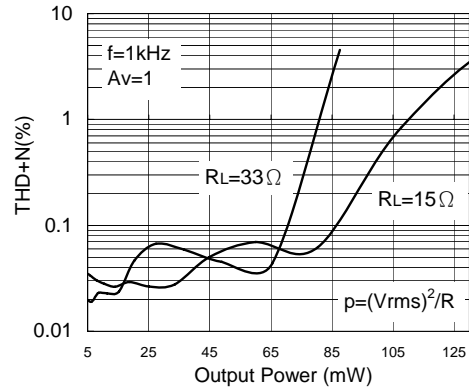

Sinking Current vs. $V_o - (V_{SS})$

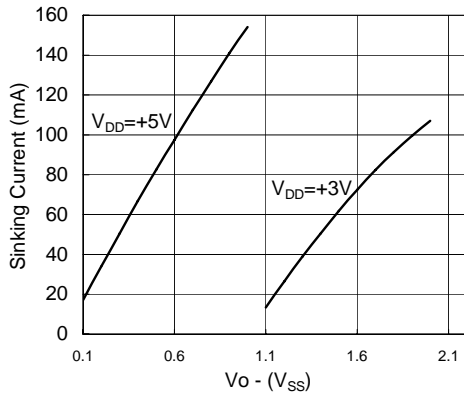

Sourcing Current vs. $(V_{DD}) - V_o$

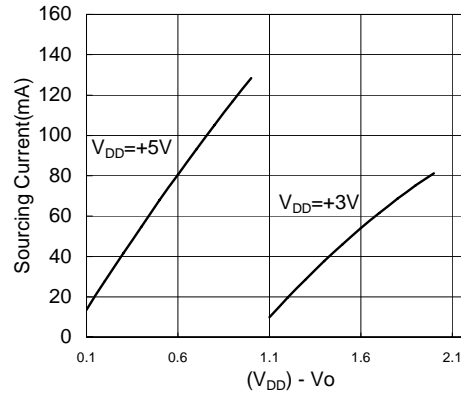

Typical Performance Characteristics (Continued)

Large Signal Transient Response

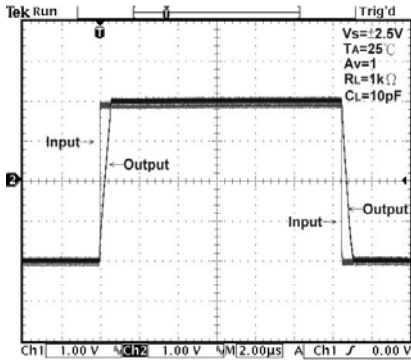

Small Signal Transient Response

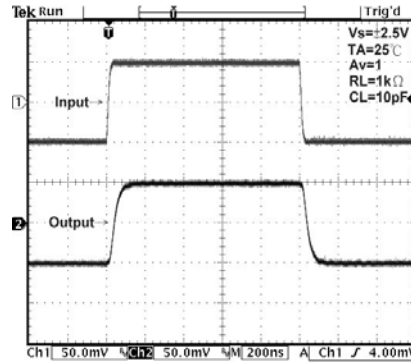

Operation with Rail-to-Rail Input and Output

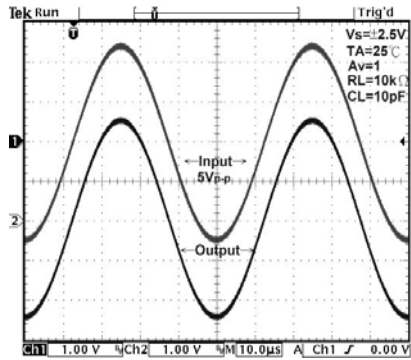

Operation with Beyond-the Rail Input

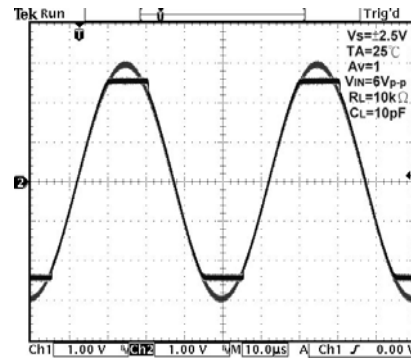

Recommended Minimum Footprint

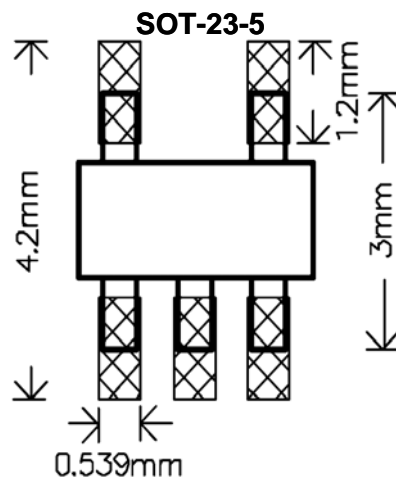
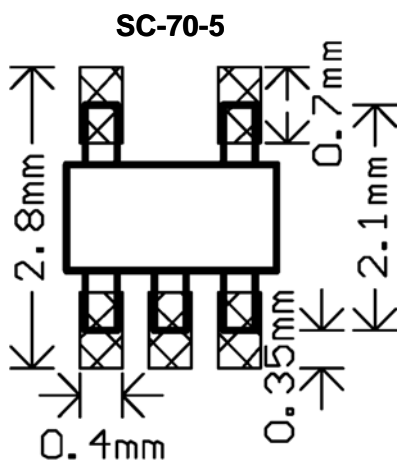

Package Information

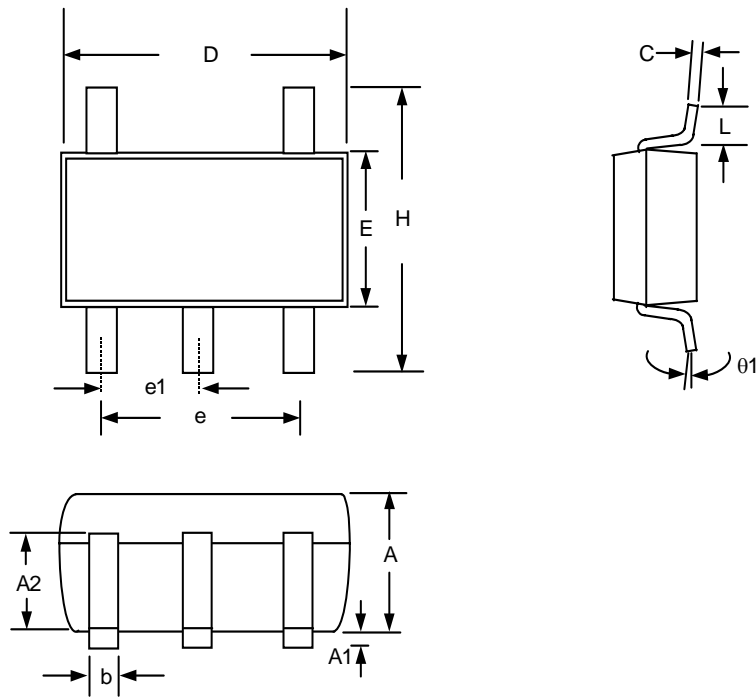

SOT-23-5 (T1) Package

Note:

1. Package body sizes exclude mold flash protrusions or gate burrs
2. Tolerance ± 0.1000 mm (4mil) unless otherwise specified
3. Coplanarity: 0.1000mm
4. Dimension L is measured in gage plane

SYMBOL	DIMENSION IN MM			DIMENSION IN INCH		
	MIN.	NOM.	MAX.	MIN.	NOM.	MAX.
A	1.00	1.10	1.30	0.039	0.043	0.051
A1	0.00	-----	0.10	0.000	-----	0.004
A2	0.70	0.80	0.90	0.028	0.031	0.035
b	0.35	0.40	0.50	0.014	0.016	0.020
C	0.10	0.15	0.25	0.004	0.006	0.010
D	2.70	2.90	3.10	0.106	0.114	0.122
E	1.40	1.60	1.80	0.055	0.063	0.071
e	-----	1.90(TYP)	-----	-----	0.075(TYP)	-----
e1	-----	0.95	-----	-----	0.037	-----
H	2.60	2.80	3.00	0.102	0.110	0.118
L	0.37	-----	-----	0.015	-----	-----
$\theta 1$	1°	5°	9°	1°	5°	9°

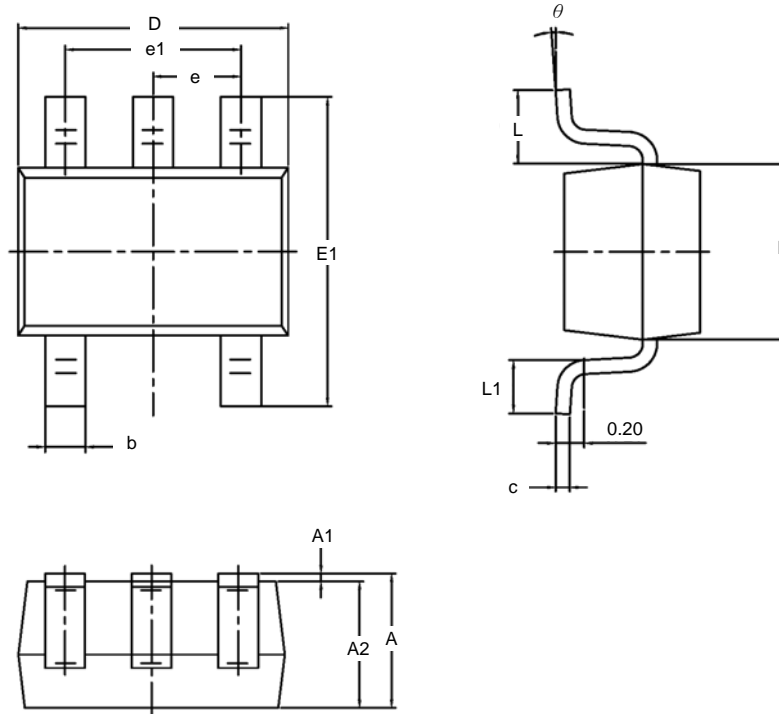

SC-70-5 (TA) Package

SYMBOL	DIMENSION IN MM		DIMENSION IN INCH	
	MIN.	MAX.	MIN.	MAX.
A	0.90	1.10	0.035	0.043
A1	0.00	0.10	0.00	0.004
A2	0.90	1.00	0.035	0.039
b	0.15	0.35	0.006	0.014
c	0.08	0.15	0.003	0.006
D	2.00	2.20	0.079	0.087
E	1.15	1.35	0.045	0.053
E1	2.15	2.45	0.085	0.096
e	0.65 TYP		0.026 TYP	
e1	1.20	1.40	0.047	0.055
L	0.525 REF		0.021 REF	
L1	0.26	0.46	0.010	0.018
θ	0°	8°	0°	8°

Taping Specification

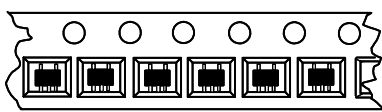

SOT-23-5 · SC-70-5L Package Orientation

PACKAGE	Q'TY/REEL
SOT-23-5	3,000 ea
SC-70-5	3,000 ea

GMT Inc. does not assume any responsibility for use of any circuitry described, no circuit patent licenses are implied and GMT Inc. reserves the right at any time without notice to change said circuitry and specifications.