

Digital transistors (built-in resistors)

Pb-Free package is available

●Features

- 1) Built-in bias resistors enable the configuration of an inverter circuit without connecting external input resistors (see equivalent circuit).
- 2) The bias resistors consist of thin-film resistors with complete isolation to allow positive biasing of the input. They also have the advantage of almost completely eliminating parasitic effects.
- 3) Only the on/off conditions need to be set for operation, making device design easy.
- 4) We declare that the material of product complies with RoHS requirements.

●Structure

PNP digital transistor
(Built-in resistor type)

LDTB123YLT1G

●Equivalent circuit

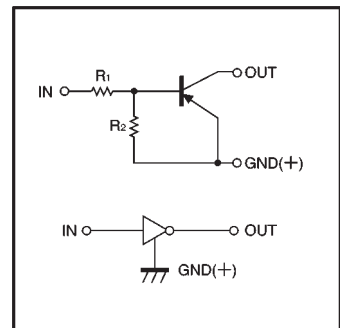

LDTB123YLT1G

Absolute maximum ratings (Ta = 25 °C)

Parameter	Symbol	Limits	Unit
Supply voltage	V _{CC}	-50	V
Input voltage	V _{IN}	-12~+5	V
Output current	I _C	-500	mA
Power dissipation	P _d	200	mW
Junction temperature	T _j	150	
Storage temperature	T _{stg}	-55~+150	

Electrical characteristics (Ta = 25 °C)

Parameter	Symbol	Min	Typ	Max	Unit	Conditions
Input voltage	V _{i(off)}	-	-	-0.3	V	V _{CC} = -5V, I _o = -100μA
	V _{i(on)}	-2	-	-		V _o = -0.3V, I _o = -20 mA
Output voltage	V _{o(on)}	-	-0.1	-0.3	V	I _o /I _i = -50 mA/-2.5 mA
Input current	I _i	-	-	-3.6	mA	V _i = -5V
Output current	I _{o(off)}	-	-	-0.5	μA	V _{CC} = -50V, V _i = 0V
DC current gain	h _{FE}	56	-	-		V _o = -5V, I _o = -50 mA
Input resistance	R ₁	1.54	2.2	2.86	k Ω	-
Resistance ratio	R ₂ /R ₁	3.6	4.5	5.5		-
Transition frequency	f _T	-	200	-	MHz	V _{CE} = -10V, I _E = 5mA, f = 100MHz*

* Transition frequency of the device

DEVICE MARKING

LDTB123YLT1G = F52

ORDERING INFORMATION

Device	Marking	Shipping
LDTB123YLT1G	F52	3000/Tape&Reel
LDTB123YLT3G	F52	10000/Tape&Reel

LDTB123YLT1G

Electrical characteristic curves

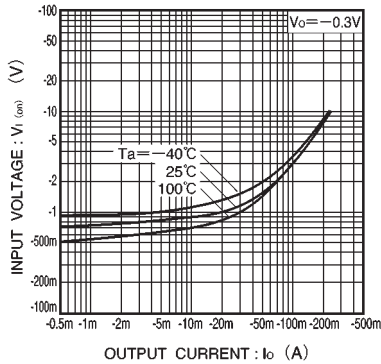

Fig.1 Input voltage vs. output current (ON characteristics)

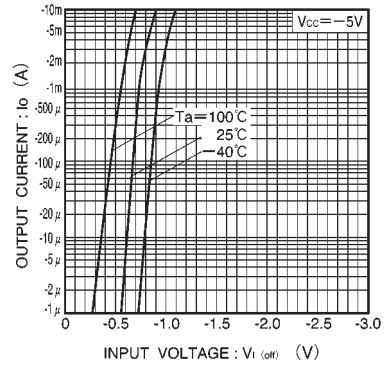

Fig.2 Output current vs. input voltage (OFF characteristics)

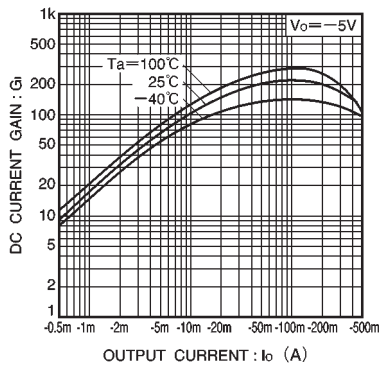

Fig.3 DC current gain vs. output current

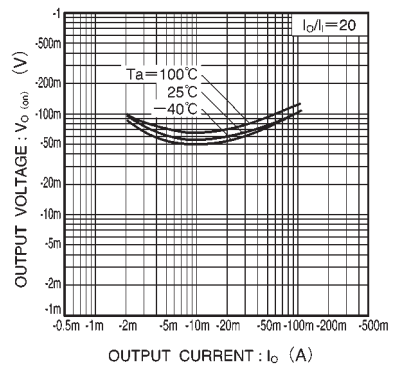

Fig.4 Output voltage vs. output current

LDTB123YLT1G

SOT-23

NOTES:

1. DIMENSIONING AND TOLERANCING PER ANSI Y14.5M, 1982
2. CONTROLLING DIMENSION: INCH.

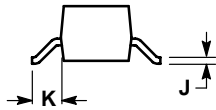
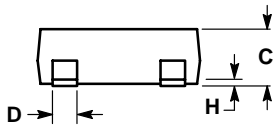
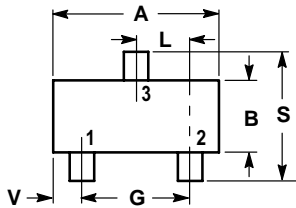

DIM	INCHES		MILLIMETERS	
	MIN	MAX	MIN	MAX
A	0.1102	0.1197	2.80	3.04
B	0.0472	0.0551	1.20	1.40
C	0.0350	0.0440	0.89	1.11
D	0.0150	0.0200	0.37	0.50
G	0.0701	0.0807	1.78	2.04
H	0.0005	0.0040	0.013	0.100
J	0.0034	0.0070	0.085	0.177
K	0.0140	0.0285	0.35	0.69
L	0.0350	0.0401	0.89	1.02
S	0.0830	0.1039	2.10	2.64
V	0.0177	0.0236	0.45	0.60

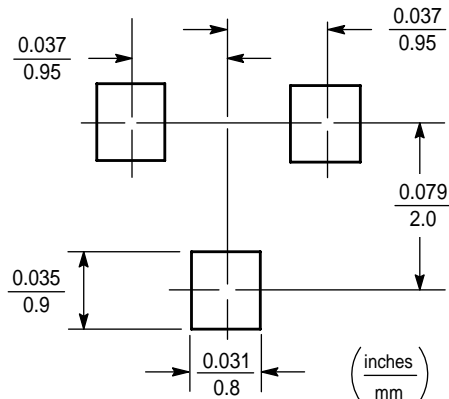

Shipment Specification

