



## PA4867

CMOS IC

### DUAL 2.1W AUDIO AMPLIFIER PLUS STEREO HEADPHONE FUNCTION

#### DESCRIPTION

The UTC **PA4867** is a stereo audio power amplifier capable of delivering typically 2.1W to a 4Ω load or 2.4W to a 3Ω load each channel with less than 1.0% THD+N using a 5V power supply. UTC **PA4867** has a new circuit topology which can eliminate headphone output coupling capacitors. And an internal input MUX allows two sets of stereo inputs to the amplifier.

The UTC **PA4867** has integrated depop circuitry that virtually eliminates transients that cause noise in the speakers during power up and when using the shutdown modes.

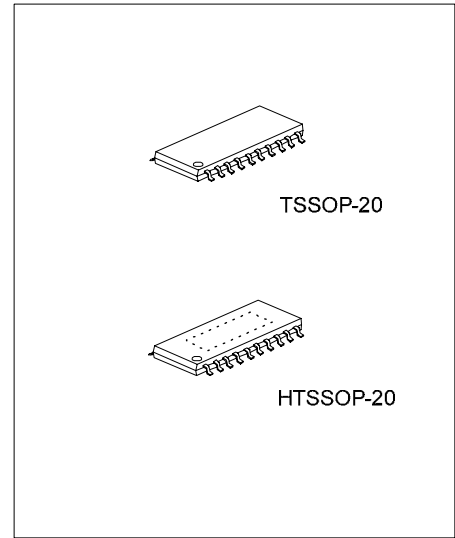

\*Pb-free plating product number: PA4867L

#### FEATURES

- \* Operating voltage range  $V_{DD}=2V\sim 5.5V$
- \* Output power:
  - 2.4W(typ.)@5V into 3Ω with 1% THD+N max (1kHz)
  - 2.1W(typ.)@5V into 4Ω with 1% THD+N max (1kHz)
- \* Eliminates SE-mode output coupling capacitors
- \* Shutdown mode available
- \* click and pop reduction circuitry
- \* Unity-gain stable
- \* Thermal-shutdown Protection
- \* Input MUX control
- \* SE/BTL mode available

#### ORDERING INFORMATION

Order Number		Package	Packing
Normal	Lead Free Plating		
PA4867-N20-R	PA4867L-N20-R	HTSSOP-20	Tape Reel
PA4867-N20-T	PA4867L-N20-T	HTSSOP-20	Tube
PA4867-P20-R	PA4867L-P20-R	TSSOP-20	Tape Reel
PA4867-P20-T	PA4867L-P20-T	TSSOP-20	Tube

<p>PA4867L-N20-T</p> <p>(1)Packing Type (2)Package Type (3)Lead Plating</p>	<p>(1) R: Tape Reel, T: Tube (2) N20: HTSSOP-20, P20: TSSOP-20 (3) L: Lead Free Plating, Blank: Pb/Sn</p>
---	---

### ■ PIN CONFIGURATION

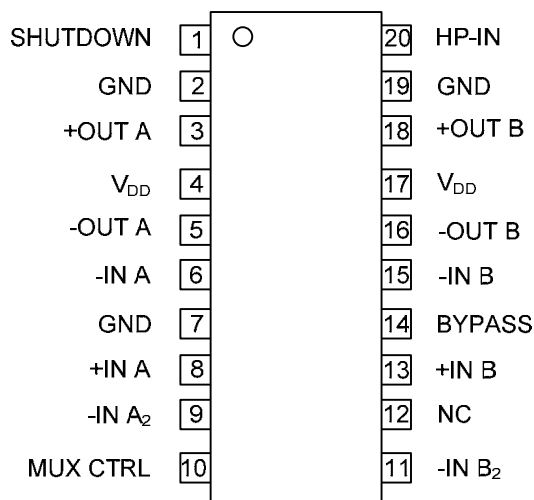

### ■ PIN DESCRIPTION

PIN NO.	PIN NAME	I/O	PIN DESCRIPTION
1	SHUTDOWN	I	Entire IC into the shutdown mode when this pin connected to the $V_{DD}$
2, 7, 19	GND		Ground
3	+OUTA	O	Channel A + output in BTL mode, high impedance in SE mode
4, 17	$V_{DD}$		Supply voltage
5	-OUTA	O	Channel A - output in BTL mode, + output in SE mode
6	-INA	I	Inverting input of channel A
8	+INA	I	Non-inverting input of channel A, connected to BYPASS pin inside the IC
9	-INA <sub>2</sub>	I	Inverting input of channel A <sub>2</sub>
10	MUX CTRL		
11	-INB <sub>2</sub>	I	Inverting input of channel B <sub>2</sub>
12	NC		No Connection
13	+INB	I	Non-inverting input of channel B, connected to BYPASS pin inside the IC
14	BYPASS		Internal mid-supply bias reference bypassing
15	-INB	I	Inverting input of channel B
16	-OUTB	O	Channel B - output in BTL mode, + output in SE mode
18	+OUTB	O	Channel B + output in BTL mode, high impedance in SE mode
20	HP-IN	I	Output mode select, connected to the $V_{DD}$ for SE mode or GND for BTL mode

## ■ ABSOLUTE MAXIMUM RATINGS

PARAMETER	SYMBOL	RATINGS	UNIT
Supply Voltage		6.0	V
Input Voltage		-0.3 ~ V <sub>DD</sub> +0.3	V
Power Dissipation	P <sub>D</sub>	Internally Limited	
Junction Temperature	T <sub>J</sub>	150	
Operating Temperature	T <sub>OPR</sub>	-40 ~ +85	
Storage Temperature	T <sub>STG</sub>	-65 ~ +150	

Note: Absolute maximum ratings are those values beyond which the device could be permanently damaged. Absolute maximum ratings are stress ratings only and functional device operation is not implied.

## ■ ELECTRICAL CHARACTERISTICS

The following specifications apply for V<sub>DD</sub>= 5V unless otherwise specified. Limits apply for T<sub>A</sub>= 25 .

PARAMETER	SYMBOL	TEST CONDITIONS	MIN	TYP	MAX	UNIT
<b>FOR ENTIRE IC</b>						
Supply Voltage	V <sub>DD</sub>		2		5.5	V
Quiescent Power Supply Current	I <sub>DD</sub>	V <sub>IN</sub> =0V, I <sub>OUT</sub> =0A, HP-IN=0V		7.5	15	mA
		V <sub>IN</sub> =0V, I <sub>OUT</sub> =0A, HP-IN=4V		3.0	6	mA
Shutdown Current	I <sub>SD</sub>	V <sub>DD</sub> applied to the SHUTDOWN pin		0.7	2	μA
<b>FOR BRIDGED-MODE OPERATION</b>						
Output Offset Voltage	V <sub>O(OFF)</sub>	V <sub>IN</sub> =0V		5	50	mV
Output Power	P <sub>OUT</sub>	THD=1%, f=1kHz	R <sub>L</sub> = 3Ω		2.2	W
			R <sub>L</sub> = 4Ω		1.9	W
			R <sub>L</sub> = 8Ω	1.0	1.1	W
		THD+N=10%, f=1kHz	R <sub>L</sub> = 3Ω		3.0	W
			R <sub>L</sub> = 4Ω		2.6	W
			R <sub>L</sub> = 8Ω		1.5	W
		THD+N=1%, f=1kHz, R <sub>L</sub> =32Ω		0.34		W
Total Harmonic Distortion+Noise	THD+N	20Hz ≤ f ≤ 20kHz, R <sub>L</sub> =4Ω, P <sub>OUT</sub> =2W		0.3		%
		A <sub>VD</sub> =2, R <sub>L</sub> =8Ω, P <sub>OUT</sub> =1W		0.3		%
Power Supply Rejection Ratio	PSRR	V <sub>DD</sub> =5V, V <sub>RIPPLE</sub> =200mV <sub>RMS</sub> , R <sub>L</sub> =8Ω, C <sub>B</sub> =2.2μF		67		dB
Channel Separation	X <sub>TALK</sub>	f=1kHz, C <sub>B</sub> =2.2μF		80		dB
Signal To Noise Ratio	SNR	V <sub>DD</sub> =5V, P <sub>OUT</sub> =1.1W, R <sub>L</sub> =8Ω		97		dB
<b>FOR SINGLE-ENDED OPERATION</b>						
Output Offset Voltage	V <sub>O(OFF)</sub>	V <sub>IN</sub> =0V		5	50	mV
Output Power	P <sub>OUT</sub>	THD = 0.5%, f = 1kHz, R <sub>L</sub> = 32Ω	75	85		mW
		THD+N = 1%, f = 1kHz, R <sub>L</sub> = 8Ω		180		
		THD+N = 1%, f = 1kHz, R <sub>L</sub> = 16Ω		165		mW
		THD+N = 1%, f = 1kHz, R <sub>L</sub> = 32Ω		88		
		THD+N = 10%, f = 1kHz, R <sub>L</sub> = 16Ω		208		mW
		THD+N = 10%, f = 1kHz, R <sub>L</sub> = 32Ω		114		
Output Voltage Swing	V <sub>OUT</sub>	THD = 0.05%, R <sub>L</sub> = 5kΩ		1		V <sub>P-P</sub>
Total Harmonic Distortion+Noise	THD+N	A <sub>V</sub> =-1, P <sub>OUT</sub> =75mW 20Hz ≤ f ≤ 20kHz, R <sub>L</sub> =32Ω		0.2		%
Power Supply Rejection Ratio	PSRR	C <sub>B</sub> =1.0μF, V <sub>RIPPLE</sub> =200mV <sub>RMS</sub> f=1kHz		52		dB
Channel Separation	X <sub>TALK</sub>	f=1kHz, C <sub>B</sub> =2.2μF		60		dB
Signal To Noise Ratio	SNR	V <sub>DD</sub> =5V, P <sub>OUT</sub> =340mW, R <sub>L</sub> =8Ω		95		dB

■ TYPICAL APPLICATION CIRCUIT

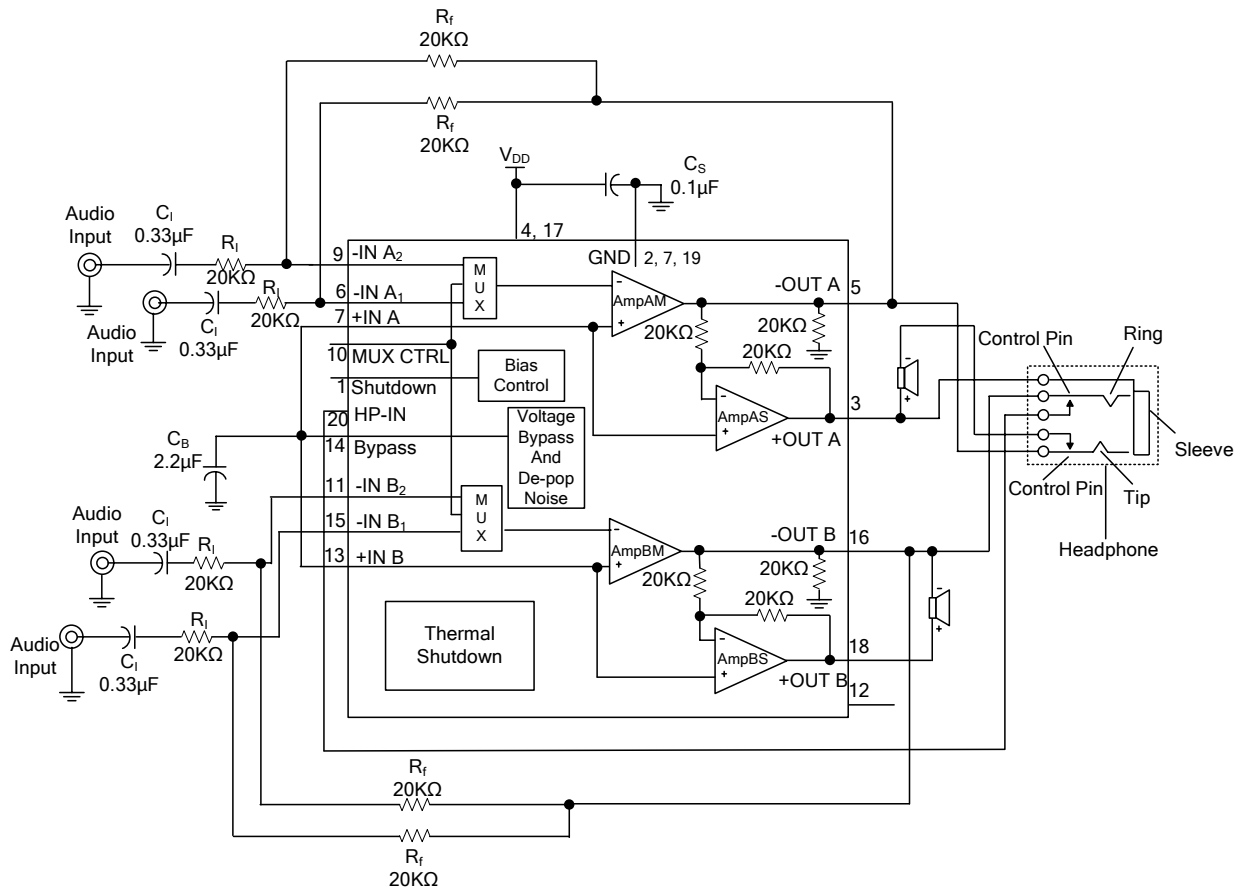
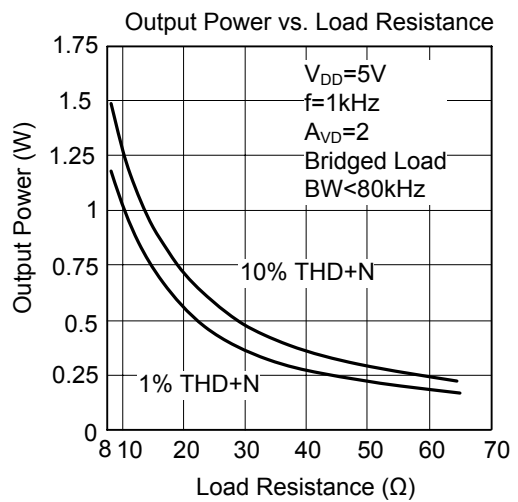
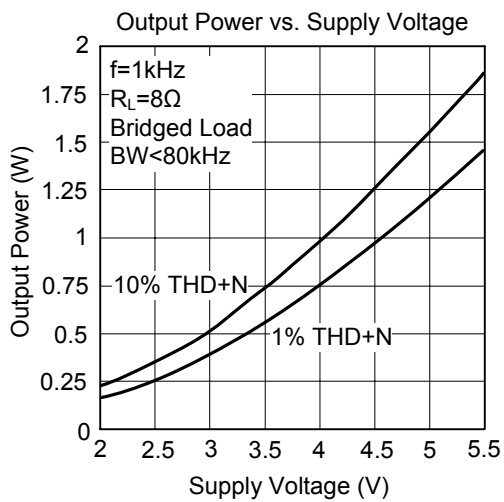
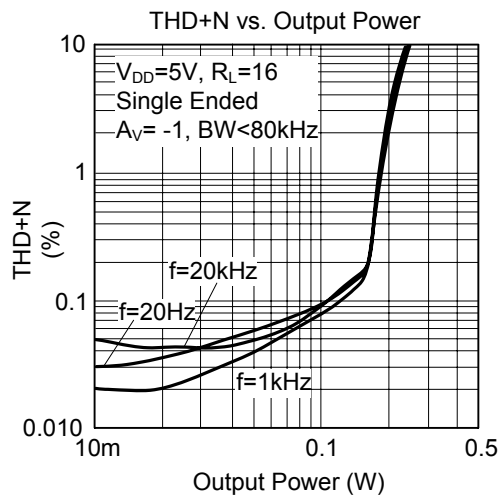
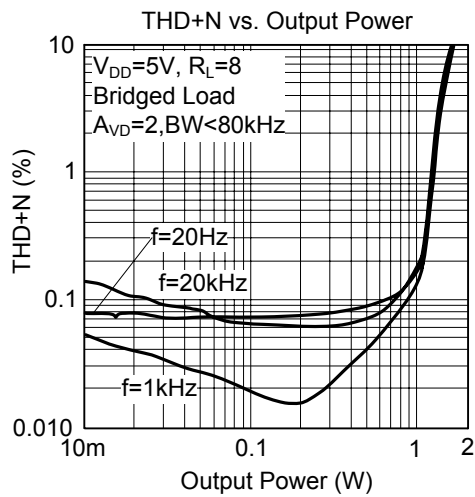
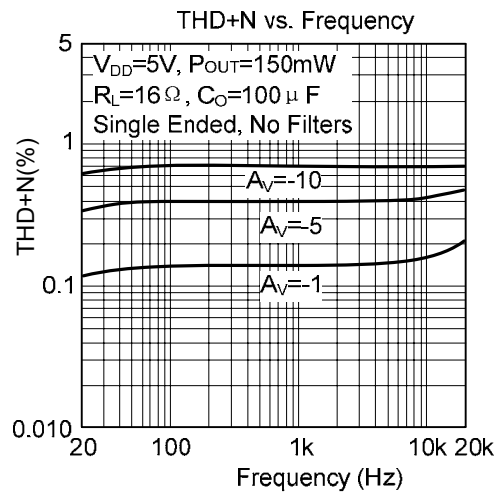
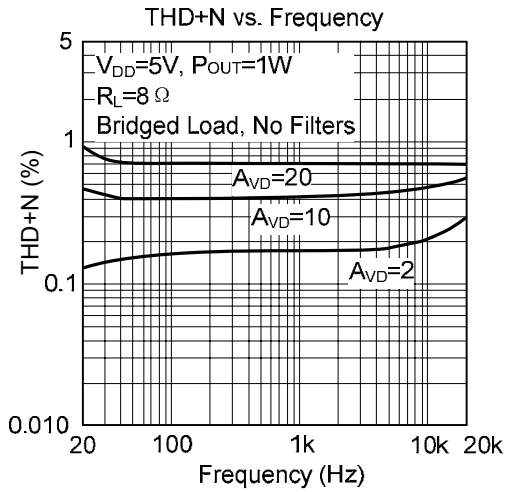
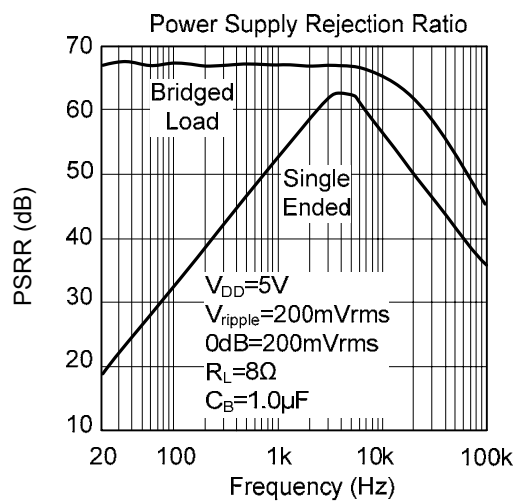
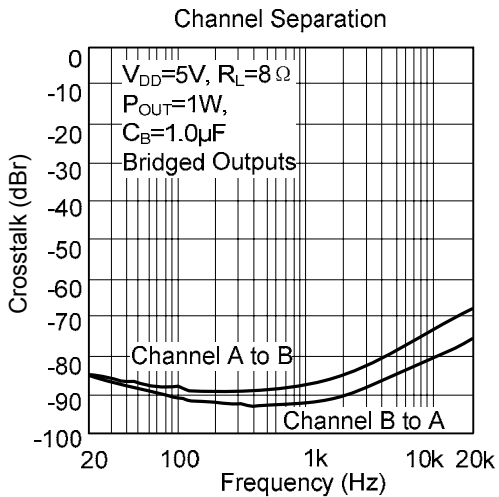
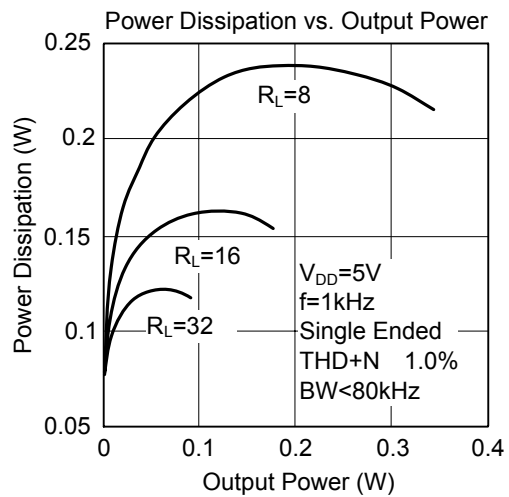
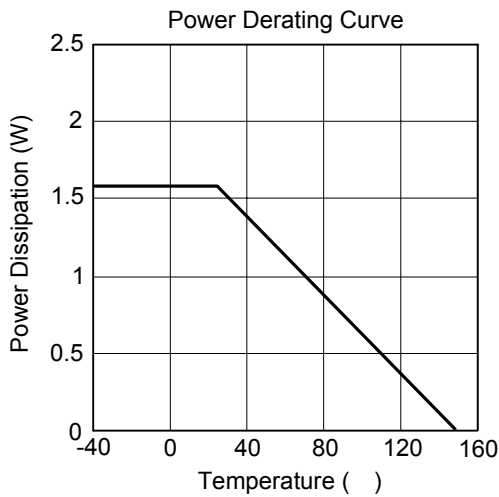
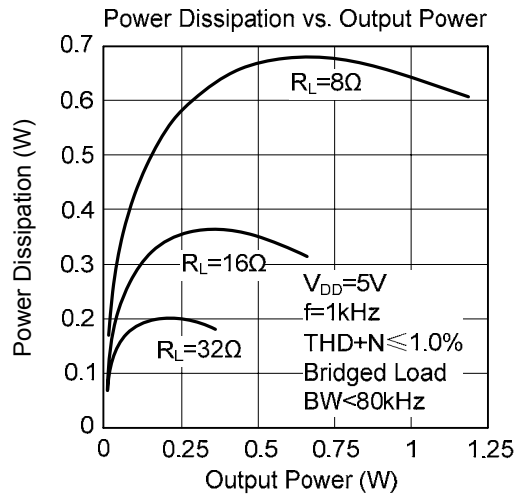
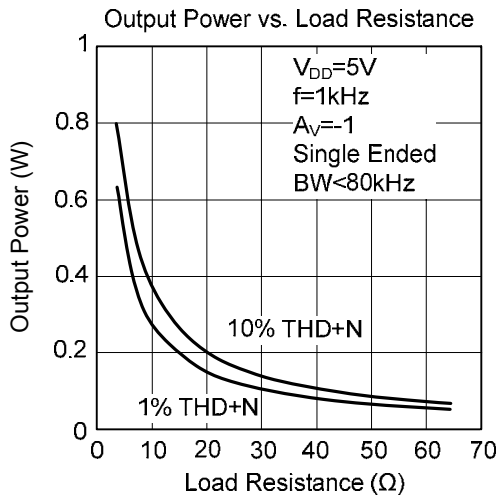

Figure 1. Typical Audio Amplifier Application Circuit

■ TYPICAL CHARACTERISTICS



■ TYPICAL CHARACTERISTICS(Cont.)



■ TYPICAL CHARACTERISTICS(Cont.)

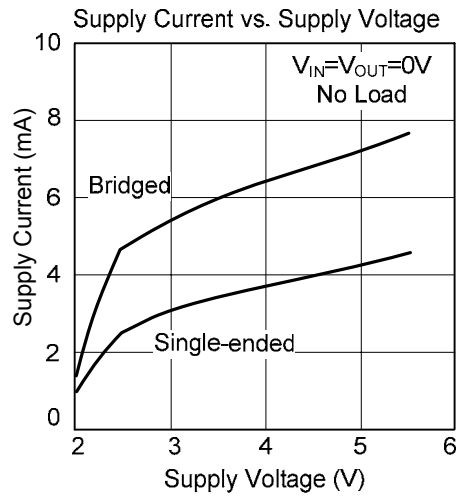
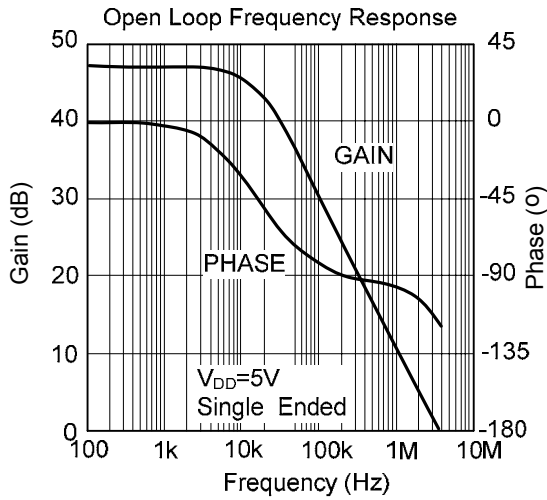

UTC assumes no responsibility for equipment failures that result from using products at values that exceed, even momentarily, rated values (such as maximum ratings, operating condition ranges, or other parameters) listed in products specifications of any and all UTC products described or contained herein. UTC products are not designed for use in life support appliances, devices or systems where malfunction of these products can be reasonably expected to result in personal injury. Reproduction in whole or in part is prohibited without the prior written consent of the copyright owner. The information presented in this document does not form part of any quotation or contract, is believed to be accurate and reliable and may be changed without notice.