

PD8042, PD8932, PD893D2

DESCRIPTION

PD8XX2 Series are InGaAs avalanche photodiodes which has a sensitive area of $\phi 50\text{mm}$.

PD8XX2 is suitable for receiving the light having a wavelength band of 1000 to 1600nm.

This photodiode features high-speed response and a high responsivity, and is suitable for the light receiving elements for optical fiber communication systems.

Feature

- $\phi 50\text{mm}$ active diameter
- 1000~1600nm wavelength band
- Small dark current
- Low noise
- High responsivity

APPLICATION

Receiver for optical communication system

ABSOLUTE MAXIMUM RATINGS <*1>

Symbol	Parameter	Conditions	Ratings	Unit
I_r	Reverse current	-	500	mA
I_f	Forward current	-	2	mA
T_c	Case temperature	-	-40 ~ +85	$^{\circ}\text{C}$
T_{stg}	Storage temperature	-	-40 ~ +100	$^{\circ}\text{C}$

Note1: The maximum rating means the limitation over which the device should not be operated even instant time, and this does not mean the guarantee of its lifetime.

As for the reliability, please refer to the reliability report from Mitsubishi Semiconductor Quality Assurance Department.

ELECTRICAL / OPTICAL CHARACTERISTICS ($T_c=25^{\circ}\text{C}$)

Symbol	Parameter	Test conditions	Limits			Unit
			Min.	Typ.	Max.	
VBR	Break-down voltage	$I_d=100\text{mA}$	40	60	90	V
I_d	Dark current	$V_r=0.9V_{BR}$	-	60	100	nA
R	Responsivity	$M=1, \lambda=1300\text{nm}$	-	0.8	-	A/W
C_t	Capacitance	$V_r=0.9V_{BR}, f=1\text{MHz}$	-	0.4 *1	0.9	pF
f_c	Cut-off frequency	$M=10, \lambda=1300\text{nm}, RL=50\text{W}, -3\text{dB}$	1.0	2.5	-	GHz

*1 Applied to PD8932: $C_t=0.5\text{pF}(\text{typ.})$, PD8042: $C_t=0.7\text{pF}(\text{typ.})$



MITSUBISHI ELECTRIC

QUALITY ASSURANCE

A range of the quality assurance is restricted as the product exposes the bare die to the external atmosphere, different from the conventional sealed package products.

Regarding the quality assurance, please confirm to Mitsubishi Semiconductor Quality Assurance Section.

PRECAUTIONS

Some characteristics of this product may change depending on the user's assembling condition. The system should be carefully designed so that problems do not occur.

SAFETY PRECAUTIONS RELATING TO HANDLING OF OPTICAL SEMICONDUCTOR DEVICE**General:**

Although the manufacturer is always striving to improve the reliability of its products, problems and errors may occur with semiconductor products. Hence, it is required so that the user's products are designed with full regard to safety by incorporating the redundancy, fire prevention, error prevention so that any problems or error with a semiconductor product does not cause any accidents resulting in injury or death, fire, or environmental damage. The following requirements must be strictly observed.

Warning!**1. Handling of the product**

This product uses GaAs (gallium arsenate). In normal conditions this product is not toxic. However, if it is powdered or vaporized, its powder or vapor is dangerous to humans. Never attempt to crush, grind, bake or chemically treat this product. Do not put this product into your mouth or swallow it.

2. Discarding the product

This product uses GaAs (gallium arsenate). It should be discarded as a specially controlled industrial waste, it should be separated from general industrial and household wastes, according to the "Law of Wastes and Cleaning".

Caution!**1. High temperature**

During operation the product may become hot. Therefore do not touch it directly during operation. The product will remain hot even after the power is turned off, so wait until it cools before you touch it. Otherwise burns may be caused. Never place any inflammable substance which may cause a fire near the product.

There is a possibility that the specification is changed without notice.





PD8XX2 SERIES

OUTLINE DRAWINGS

PD8042



-  CD header
-  Flat glass cap
-  3 pin

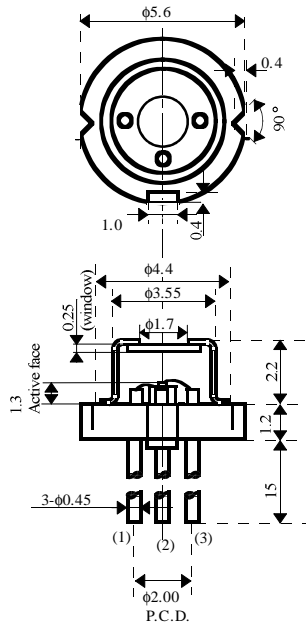

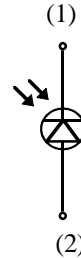

Unit: mm

<Lead Connection>
 (1) Cathode
 (2) Case
 (3) Anode

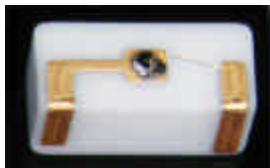

PD8932



-  Alumina submount

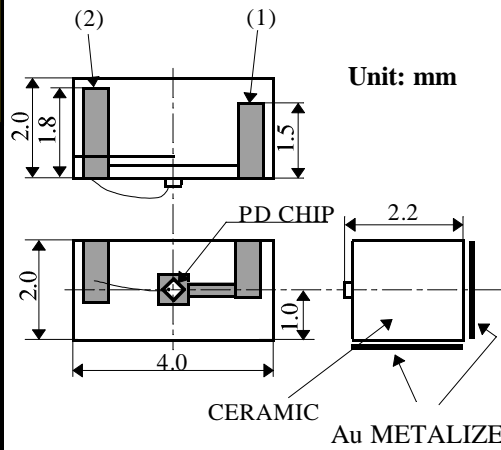

Unit: mm



PD893D2

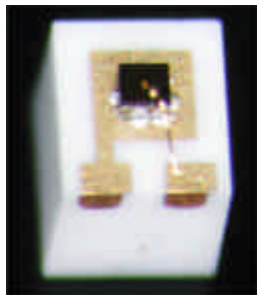

-  Alumina submount

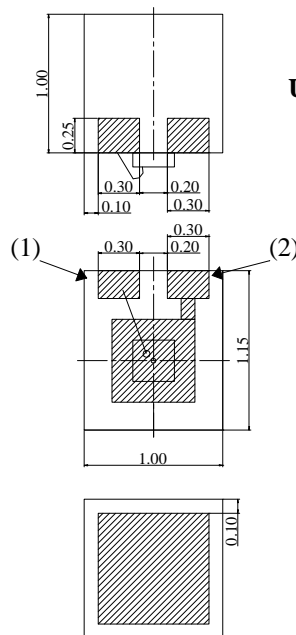

Unit: mm

<Lead Connection>
 (1) Anode
 (2) Cathode

