

Capsule Type Rectifier Diode SHXXC540

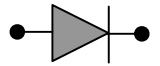

Symbol	Characteristics	Conditions	T _J (°C)	Value	Unit
BLOCKING PARAMETERS					
V _{RRM}	Repetitive peak reverse voltage		170	200-1800	V
I _{RRM}	Repetitive peak reverse current	V = V _{RRM}	170	50	mA
CONDUCTING PARAMETERS					
I _{F(AV)}	Average on-state current	180 sine, 50Hz, T _C = 91°C		540	A
I _{RMS}	RMS on-state current			850	A
I _{FSM}	Non repetitive peak surge on-state current	Sine wave, 10mS without reverse voltage	170	6000	A
I ² t	Permissible surge energy			180	kA ² S
V _{FM}	Peak on-state voltage drop	On-state current = 1600A	170	1.85	V
V ₀	Typical forward conduction Threshold voltage		170	0.75	V
r ₀	Typical forward slope resistance		170	0.65	mΩ
THERMAL & MECHANICAL PARAMETERS					
R _{TH(J-C)}	Thermal impedance, 180° conduction, Sine	Junction to case		0.090	°C/W
R _{TH(C-HK)}	Thermal impedance	Case to heatsink		0.015	°C/W
T _J	Maximum Permissible junction temperature			170	°C
T _{STG}	Storage temperature range			-40 – 170	°C
F	Mounting Torque			6.5	KN
W	Weight			70	gms



HIND RECTIFIERS LTD

Capsule Type Rectifier Diode SHXXC540

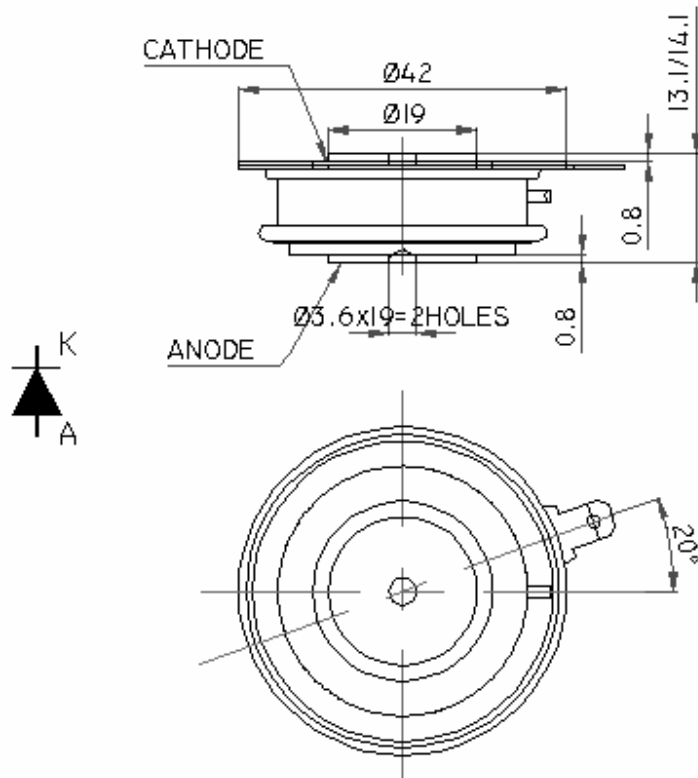
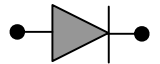

All dimensions in mm

On State Power Loss

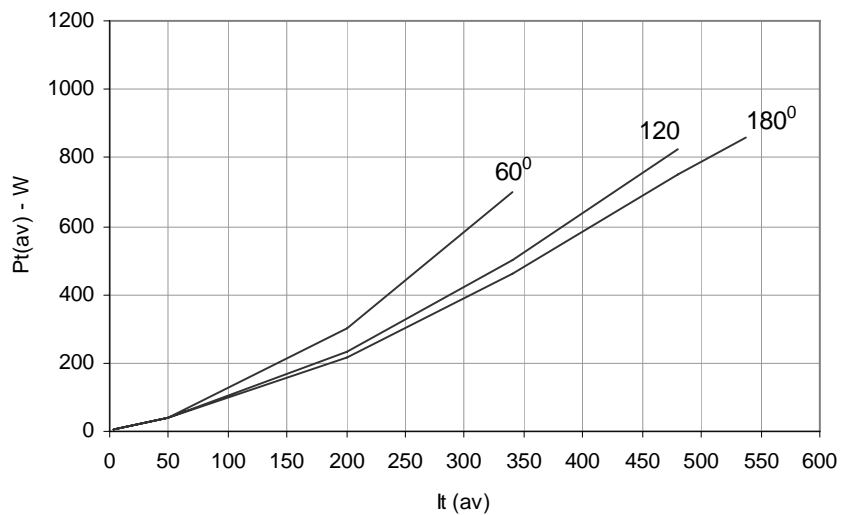

HIND RECTIFIERS LTD

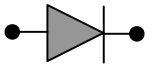

Maximum Permissible Case Temp

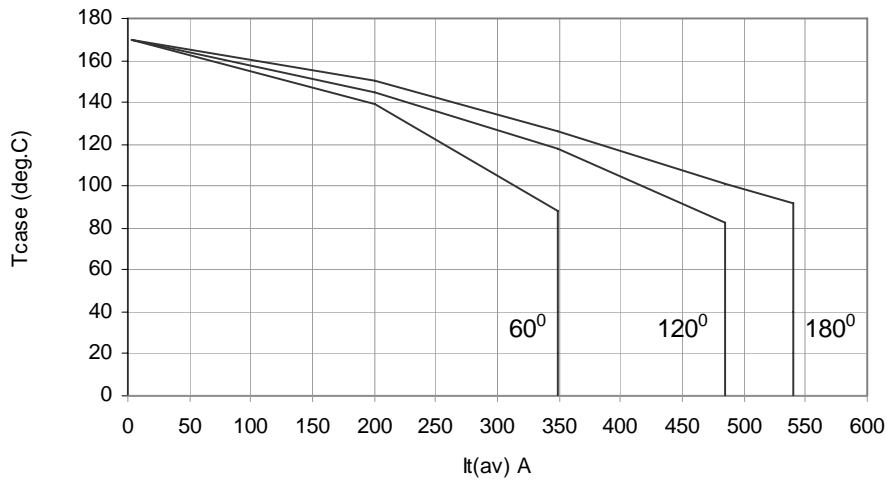

Max non repetitive Surge Current

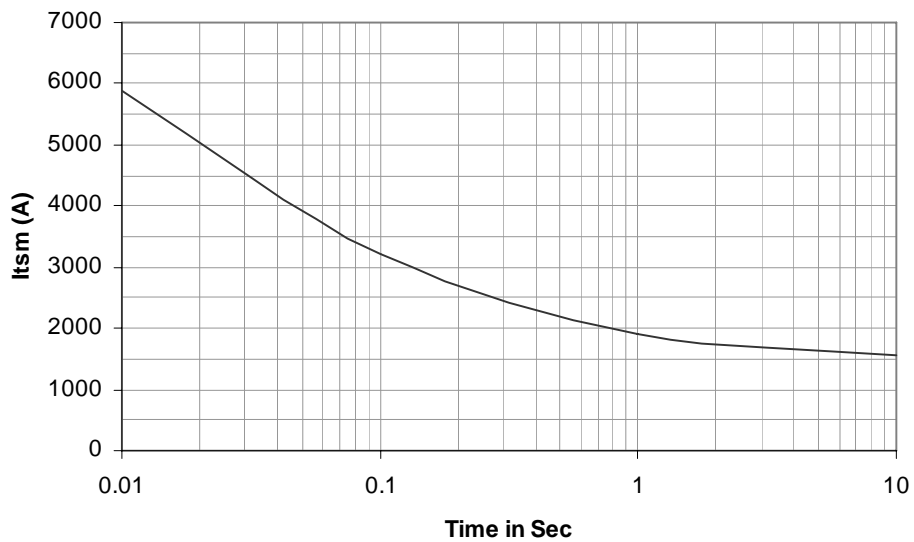

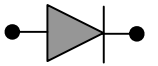

Transient Thermal Impedance Junction to Case

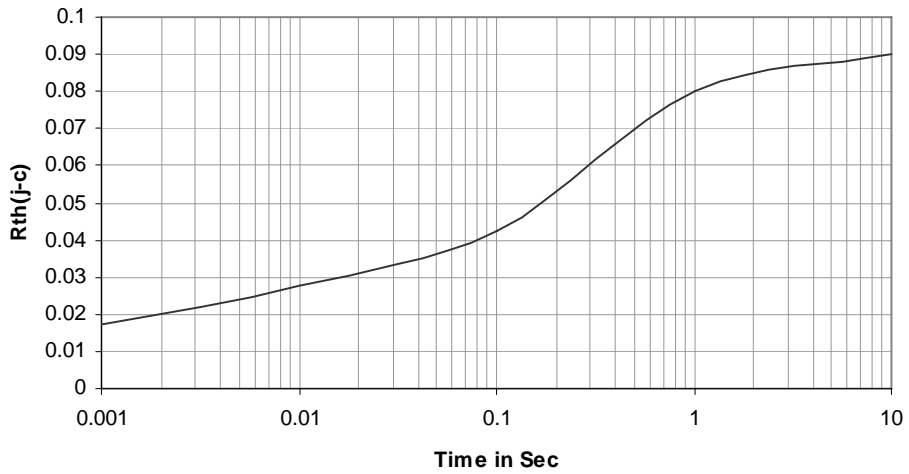

On State Characteristics

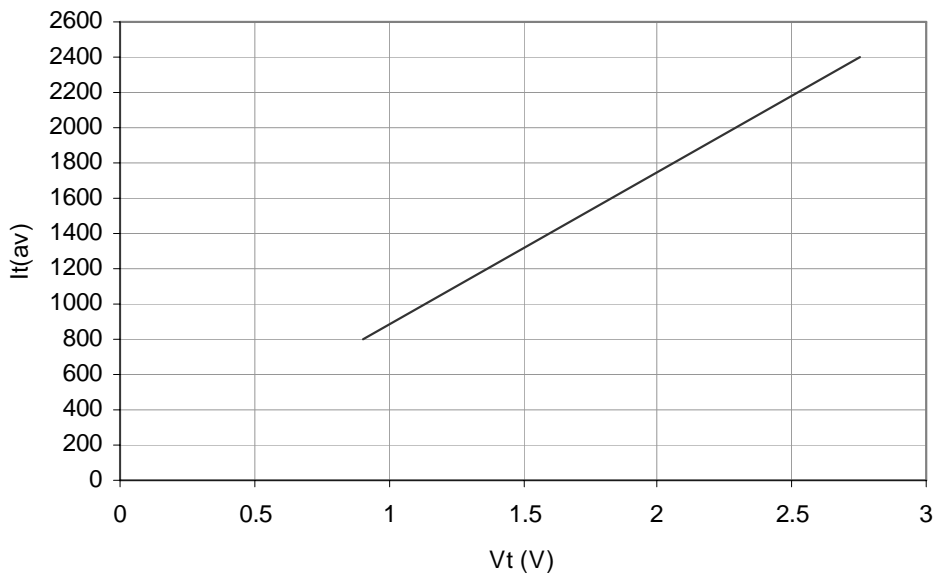

Capsule Type Rectifier Diode SHXXC540

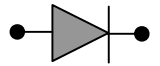

Ordering Information: -

SH	XX	C	540
Hirect make Capsule Diode	$V_{RRM} = XX * 100$ e.g.12 * 100 =1200V	Capsule Diode	$I_{F(AV)} = 540A$

Hind Rectifiers Ltd reserves the right to change the specifications without notice.

This datasheet specifies technical information for semiconductor devices but promises no characteristics. No warranty or guarantee expressed or implied is made regarding delivery, performance or suitability.

Hind Rectifiers Ltd

Lake Road

Bhandup (West)

Mumbai – 400 078

Tel: - +91 22 2596 8027/28/29/31

Fax: - +91 22 2596 4114

E-mail: - marketing@hirect.com

Website: - www.hirect.com

June-2008



HIND RECTIFIERS LTD

5 of 5