

Silicon NPN Power Transistors

2SD1236L

DESCRIPTION

- With TO-220C package
- Complement to type 2SB920L
- Low collector saturation voltage
- Large current capacity.

APPLICATIONS

- Relay drivers, high speed inverters, converters, and other general high-current switching applications

PINNING

PIN	DESCRIPTION
1	Base
2	Collector; connected to mounting base
3	Emitter

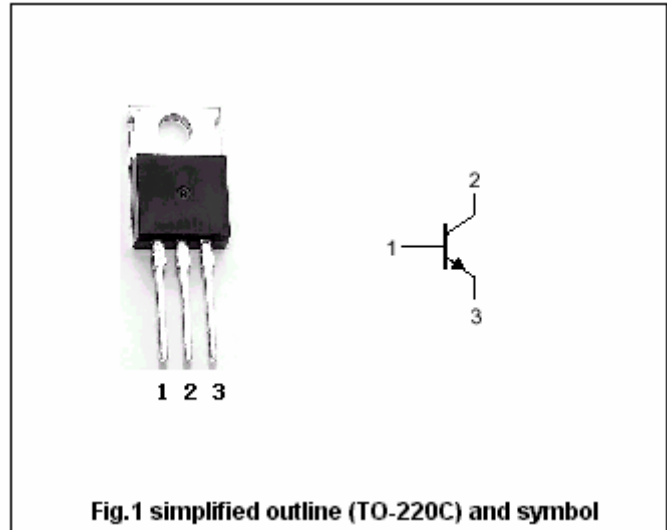
Absolute maximum ratings($T_a=25^{\circ}\text{C}$)

SYMBOL	PARAMETER	CONDITIONS	VALUE	UNIT
V_{CBO}	Collector-base voltage	Open emitter	90	V
V_{CEO}	Collector-emitter voltage	Open base	80	V
V_{EBO}	Emitter-base voltage	Open collector	6	V
I_C	Collector current (DC)		5	A
I_{CM}	Collector current-peak		9	A
P_C	Collector dissipation	$T_C=25^{\circ}\text{C}$	30	W
			1.75	
T_j	Junction temperature		150	$^{\circ}\text{C}$
T_{stg}	Storage temperature		-55~150	$^{\circ}\text{C}$

Silicon NPN Power Transistors

2SD1236L

CHARACTERISTICS

T_j=25°C unless otherwise specified

SYMBOL	PARAMETER	CONDITIONS	MIN	TYP.	MAX	UNIT
V _{(BR)CEO}	Collector-emitter breakdown voltage	I _C =1mA ; R _{BE} =∞	80			V
V _{(BR)CBO}	Collector-base breakdown voltage	I _C =1mA ; I _E =0	90			V
V _{(BR)EBO}	Emitter-base breakdown voltage	I _E =1mA ; I _C =0	6			V
V _{CEsat}	Collector-emitter saturation voltage	I _C =3A ; I _B =0.3A			0.4	V
I _{CBO}	Collector cut-off current	V _{CB} =80V ; I _E =0			100	μ A
I _{EBO}	Emitter cut-off current	V _{EB} =4V ; I _C =0			100	μ A
h _{FE-1}	DC current gain	I _C =1A ; V _{CE} =2V	70		280	
h _{FE-2}	DC current gain	I _C =3A ; V _{CE} =2V	30			
f _T	Transition frequency	I _C =1A ; V _{CE} =5V		20		MHz

Switching times

t _{on}	Turn-on time	I _C =10I _{B1} =-10I _{B2} =2A V _{CC} =50V, R _L =25 Ω		0.1		μ s
t _s	Storage time			1.2		μ s
t _f	Fall time			0.4		μ s

◆ h_{FE-1} Classifications

Q	R	S
70-140	100-200	140-280

Silicon NPN Power Transistors

2SD1236L

PACKAGE OUTLINE

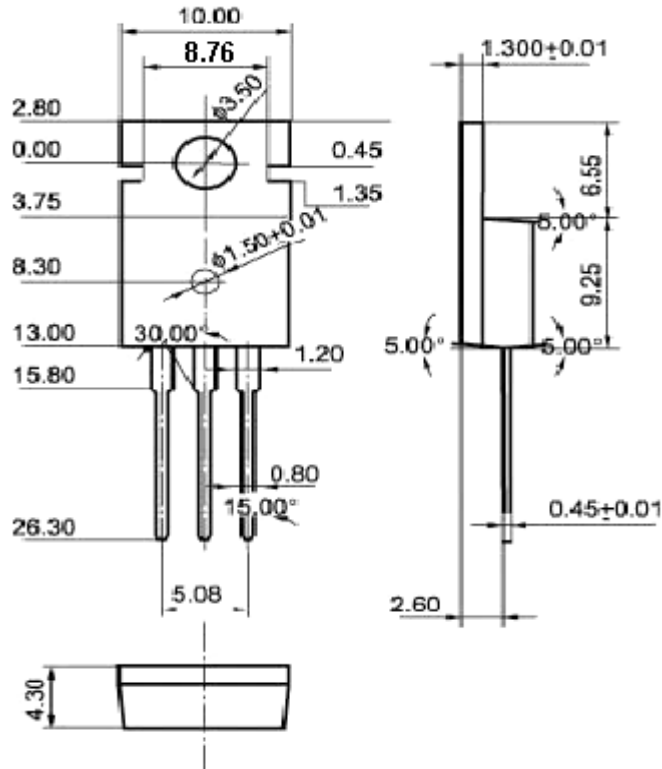

Fig.2 Outline dimensions (unindicated tolerance: ±0.10mm)

Silicon NPN Power Transistors

2SD1236L

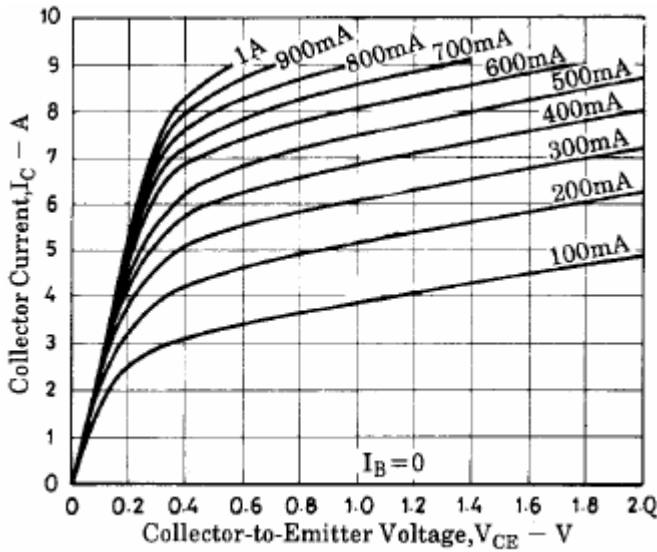

Fig.3 Static Characteristic

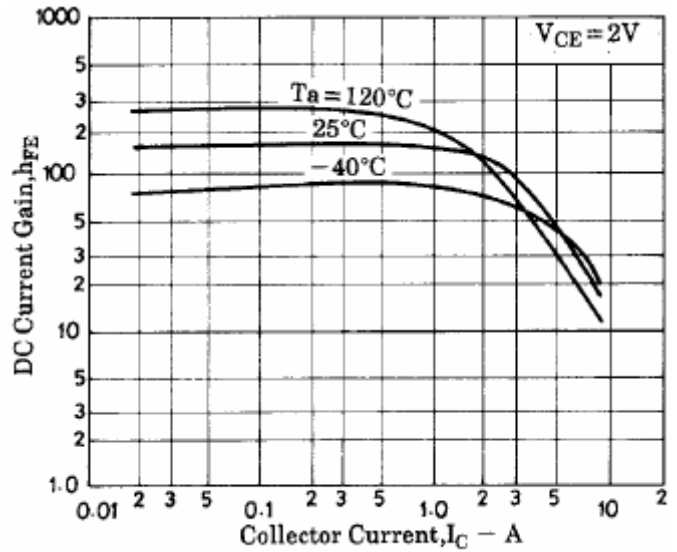

Fig.4 DC current Gain

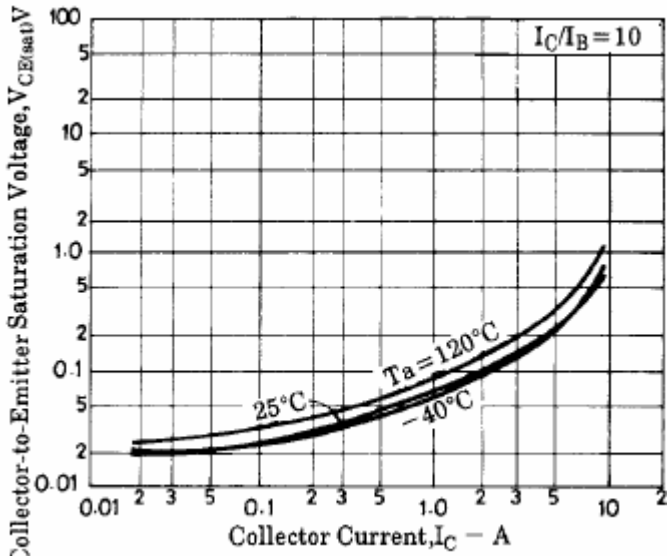

Fig.5 Collector-Emitter Saturation Voltage

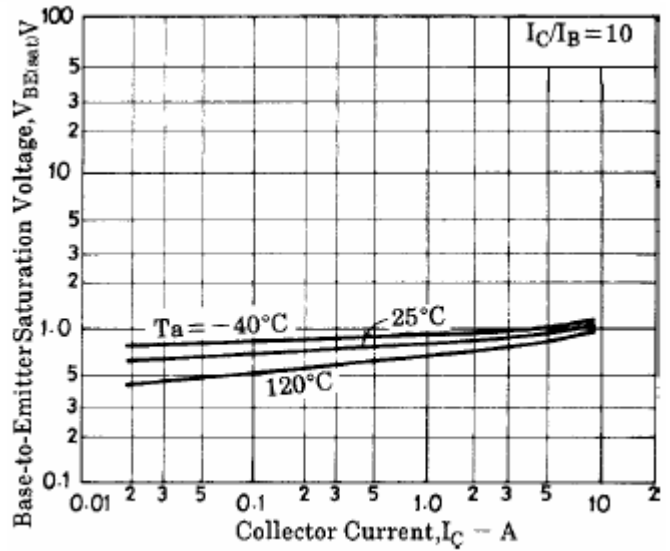

Fig.6 Base-Emitter Saturation Voltage

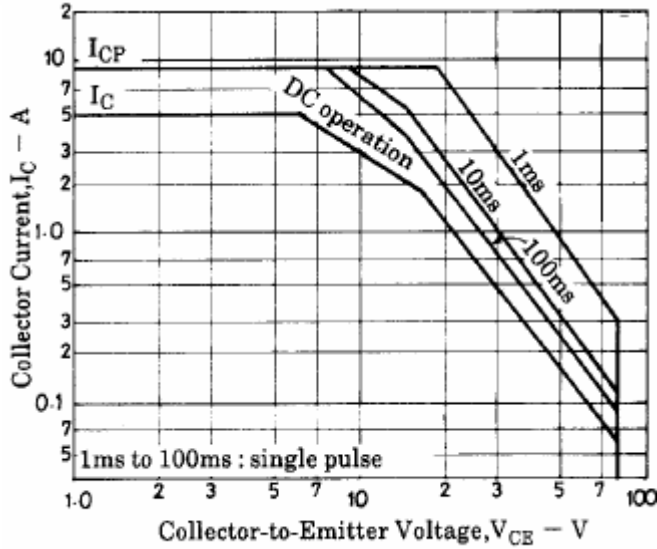

Fig.7 Safe Operating Area