

Thin Film Chip Inductors

Type KL73 Series

ISO 9001:2000
CERTIFIED
TS-16949
CERTIFIED

1. Scope

This specification applies to Thin Film Chip Inductors (KL73) 1H, 1E, 1J, 2A and 2B sizes produced by KOA Corporation.

2. Dimensions and Construction

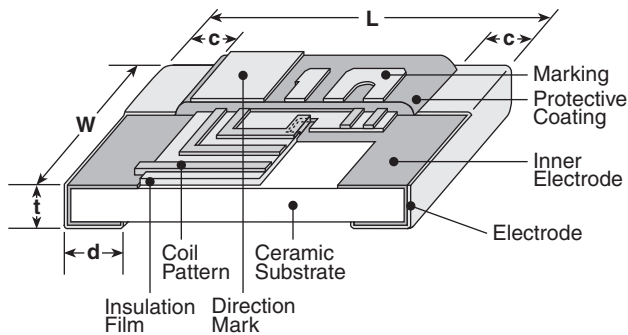

Type (Inch Size Code)	Dimensions inches (mm)				
	L	W	c	d	t
1H (0201)	.024±.001 (0.6±0.03)	.01±.001 (0.3±0.03)	.003±.002 (0.08±0.05)	.006±.002 (0.15±0.05)	.009±.001 (0.23±0.03)
1E (0402)	.039±.004 (1.0±0.1)	.02±.002 (0.5±0.05)	.006±.004 (0.15±0.1)	.01±.004 (0.25±0.1)	.014±.002 (0.35±0.05)
1J (0603)	.063±.008 (1.6±0.2)	.031±.004 (0.8±0.1)	.012±.004 (0.3±0.1)	.012±.004 (0.3±0.1)	.02±.004 (0.5±0.1)
2A (0805)	.079±.008 (2.0±0.2)	.049±.008 (1.25±0.2)	.016±.008 (0.4±0.2)	.012±.004 (0.3±0.2)	.02±.004 (0.5±0.1)
2B (1206)	.126±.008 (3.2±0.2)	.063±.008 (1.6±0.2)	.02±.008 (0.5±0.2)	.016 ^{+0.008} _{-.004} (0.4 ^{+0.2} _{-0.1})	.024±.004 (0.6±0.1)

3. Type Designation

The type designation shall be the following form:

New Type

KL73	2A	T	TE	4N7	G
Type	Size	Termination Material	Packaging	Nominal Inductance	Tolerance
	1H: 0201 1E: 0402 1J: 0603 2A: 0805 2B: 1206	T: Sn (Other termination styles available, contact factory for options)	TP: 7" Embossed Paper 2mm Pitch (1E only - 10,000 pcs/reel) TE: 7" Embossed Plastic 4mm Pitch (1J, 2A, 2B - 4,000 pcs/reel) TB: 7" Paper Tape 2mm Pitch (1H only - 10,000 pcs/reel)	4N7: 4.7nH 47N: 47nH	B: ±0.1nH C: ±0.2nH G: ±2% J: ±5%

4. Application and Ratings

Part Designation	Inductance (nH)	Inductance Tolerance	Quality Factor Minimum	Self Resonant Frequency Minimum (MHz)	DC Resistance Maximum (Ω)	Allowable DC Current Maximum (mA)	Measured Frequency (MHz)
KL731HTTB0N6*	0.6	B: ± 0.1 nH, C: ± 0.2 nH	5	9000	0.20	350	500
KL731HTTB0N7*	0.7	B: ± 0.1 nH					
KL731HTTB0N8*	0.8	B: ± 0.1 nH, C: ± 0.2 nH					
KL731HTTB0N9*	0.9	B: ± 0.1 nH					
KL731HTTB1N0*	1.0	B: ± 0.1 nH, C: ± 0.2 nH					
KL731HTTB1N1*	1.1	B: ± 0.1 nH					
KL731HTTB1N2*	1.2	B: ± 0.1 nH, C: ± 0.2 nH					
KL731HTTB1N3*	1.3	B: ± 0.1 nH					
KL731HTTB1N5*	1.5	B: ± 0.1 nH, C: ± 0.2 nH					
KL731HTTB1N6*	1.6	B: ± 0.1 nH					
KL731HTTB1N8*	1.8	B: ± 0.1 nH, C: ± 0.2 nH					
KL731HTTB2N0*	2.0	B: ± 0.1 nH			8000	0.70	
KL731HTTB2N2*	2.2	B: ± 0.1 nH, C: ± 0.2 nH					
KL731HTTB2N4*	2.4	B: ± 0.1 nH					
KL731HTTB2N7*	2.7	B: ± 0.1 nH, C: ± 0.2 nH					
KL731HTTB3N0*	3.0	B: ± 0.1 nH					
KL731HTTB3N3*	3.3	B: ± 0.1 nH, C: ± 0.2 nH					
KL731HTTB3N6*	3.6	B: ± 0.1 nH		6000	1.00	130	
KL731HTTB3N9*	3.9	B: ± 0.1 nH, C: ± 0.2 nH					
KL731HTTB4N3*	4.3	B: ± 0.1 nH					
KL731HTTB4N7*	4.7	B: ± 0.1 nH, C: ± 0.2 nH					
KL731HTTB5N1*	5.1	G: $\pm 2\%$					
KL731HTTB5N6*	5.6	G: $\pm 2\%$, J: $\pm 5\%$					
KL731HTTB6N2*	6.2	G: $\pm 2\%$		4000	2.50	110	
KL731HTTB6N8*	6.8	G: $\pm 2\%$, J: $\pm 5\%$					
KL731HTTB7N5*	7.5	G: $\pm 2\%$					
KL731HTTB8N2*	8.2	G: $\pm 2\%$, J: $\pm 5\%$					
KL731HTTB9N1*	9.1	G: $\pm 2\%$					
KL731HTTB10N*	10	G: $\pm 2\%$ J: $\pm 5\%$				2000	
KL731HTTB11N*	11						
KL731HTTB12N*	12						
KL731HTTB13N*	13						
KL731HTTB15N*	15						
KL731HTTB16N*	16						
KL731HTTB18N*	18			1500	6.00	50	
KL731HTTB20N*	20						
KL731HTTB22N*	22						
KL731HTTB24N*	24						
KL731HTTB27N*	27						
KL731HTTB33N*	33						
KL731HTTB39N*	39	800	7.00	40	200		

* Add tolerance character (B, C, G, J)

4. Application and Ratings *Continued*

Part Designation	Inductance (nH)	Inductance Tolerance	Quality Factor Minimum	Self Resonant Frequency Minimum (MHz)	DC Resistance Maximum (Ω)	Allowable DC Current Maximum (mA)	Measured Frequency (MHz)				
KL731ETTPN56B	0.56	B: ± 0.1 nH	7	14000	0.10	700	500				
KL731ETTPN68B	0.68										
KL731ETTPN82B	0.82										
KL731ETTP1N0*	1.0	B: ± 0.1 nH C: ± 0.2 nH	10	12000	0.15	650	500				
KL731ETTP1N2*	1.2			10000	0.20						
KL731ETTP1N5*	1.5			8000	0.25						
KL731ETTP1N8*	1.8			6000	0.30						
KL731ETTP2N2*	2.2			5000	0.50						
KL731ETTP2N7*	2.7				550						
KL731ETTP3N3*	3.3			4000	3000			1.00	600		
KL731ETTP3N9*	3.9								500		
KL731ETTP4N7*	4.7			G: $\pm 2\%$ J: $\pm 5\%$	7			5000	3.00	450	200
KL731ETTP5N6*	5.6							4000		350	
KL731ETTP6N8*	6.8	3000	300								
KL731ETTP8N2*	8.2	2500	250								
KL731ETTP10N*	10	2000	200								
KL731ETTP12N*	12	1500	5.00			150					
KL731ETTP15N*	15										
KL731ETTP18N*	18	1000									
KL731ETTP22N*	22										
KL731ETTP27N*	27										
KL731ETTP33N*	33										
KL731JTTE1N0*	1.0	C: ± 0.2 nH	10	13000	0.10	650	500				
KL731JTTE1N2*	1.2		15								
KL731JTTE1N5*	1.5		20					10000			
KL731JTTE1N8*	1.8							8000	0.15		
KL731JTTE2N2*	2.2							6000	0.25		
KL731JTTE2N7*	2.7							5000	0.50	350	
KL731JTTE3N3*	3.3										
KL731JTTE3N9*	3.9		4000					3000	1.0	250	
KL731JTTE4N7*	4.7										
KL731JTTE5N6*	5.6		G: $\pm 2\%$ J: $\pm 5\%$					25	2500	1.50	200
KL731JTTE6N8*	6.8	2000									
KL731JTTE8N2*	8.2	1500		2.50	150						
KL731JTTE10N*	10										
KL731JTTE12N*	12	1000		5.00	100						
KL731JTTE15N*	15										
KL731JTTE18N*	18	600		4.00	100						
KL731JTTE22N*	22										
KL731JTTE27N*	27	600		4.50	100						
KL731JTTE33N*	33										
KL731JTTE39N*	39	600	5.00	100							
KL731JTTE47N*	47										
KL731JTTE56N*	56										
KL731JTTE68N*	68										
KL731JTTE82N*	82										

* Add tolerance character (B, C, G, J)

4. Application and Ratings *Continued*

Part Designation	Inductance (nH)	Inductance Tolerance	Quality Factor Minimum	Self Resonant Frequency Minimum (MHz)	DC Resistance Maximum (Ω)	Allowable DC Current Maximum (mA)	Measured Frequency (MHz)	
KL732ATTE1N0*	1.0	C: $\pm 0.2\text{nH}$	20	13000	0.25	900	500	
KL732ATTE1N2*	1.2			10000				
KL732ATTE1N5*	1.5			9000				
KL732ATTE1N8*	1.8		25	8000		0.50		800
KL732ATTE2N2*	2.2			6000				
KL732ATTE2N7*	2.7			5000				
KL732ATTE3N3*	3.3			4500				
KL732ATTE3N9*	3.9			4000				
KL732ATTE4N7*	4.7			3000				
KL732ATTE5N6*	5.6			G: $\pm 2\%$ J: $\pm 5\%$				20
KL732ATTE6N8*	6.8	500						
KL732ATTE8N2*	8.2	15	250					
KL732ATTE10N*	10		200					
KL732ATTE12N*	12	10			150			
KL732ATTE15N*	15		800					
KL732ATTE18N*	18	700						
KL732ATTE22N*	22		500					
KL732ATTE27N*	27	150						
KL732ATTE33N*	33		200					
KL732ATTE39N*	39	15		400				
KL732ATTE47N*	47		400					
KL732ATTE56N*	56	200						
KL732ATTE68N*	68		200					
KL732ATTE82N*	82	200						
KL732BTTE2N2*	2.2		C: $\pm 0.2\text{nH}$	25	9000	0.25	1000	500
KL732BTTE2N7*	2.7	7000						
KL732BTTE3N3*	3.3	6000						
KL732BTTE3N9*	3.9	35		5000	0.50		900	
KL732BTTE4N7*	4.7			4500				
KL732BTTE5N6*	5.6			4000				
KL732BTTE6N8*	6.8			3500				
KL732BTTE8N2*	8.2			3000				
KL732BTTE10N*	10			800				
KL732BTTE12N*	12						2500	
KL732BTTE15N*	15	40	2000	1.00	500			
KL732BTTE18N*	18		1500					
KL732BTTE22N*	22	25	1000	2.00	400			
KL732BTTE27N*	27					200		
KL732BTTE33N*	33	15	500					
KL732BTTE39N*	39		400					
KL732BTTE47N*	47	200						
KL732BTTE56N*	56		200					
KL732BTTE68N*	68	200						
KL732BTTE82N*	82		200					
KL732BTTE100*	100	200						
				400				

* Add tolerance character (B, C, G, J)

6. Characteristics

6-1 Test Condition

Unless otherwise specified, the standard range of atmospheric conditions for marking measurements and tests is as follows:

Ambient temperature: $20 \pm 15^\circ\text{C}$
Relative humidity: $65 \pm 20\%$

If there may be any doubt on results, measurements shall be made within the following limits:

Ambient temperature: $20 \pm 2^\circ\text{C}$
Relative humidity: $65 \pm 5\%$

6-2 Measurement Method of L and Q

Test equipment: Hewlett Packard RF Impedance analyzer 4191A
Fixture: Hewlett Packard Test fixture 16092A
Measuring frequency: 500 MHz/1.0nH ~ 22nH (1.0nH ~ 15nH)
200 MHz/27nH ~ 100nH (18nH ~ 47nH)

1. Perform auto-calibration to the HP4191A .275" (7 mm) unknown connector connected to 0Ω/0S/50Ω standard terminations.
2. Connected the test fixture 16092A.
Measure the open circuit admittance (G_o , B_o), and the short circuit impedance (R_o , X_o).

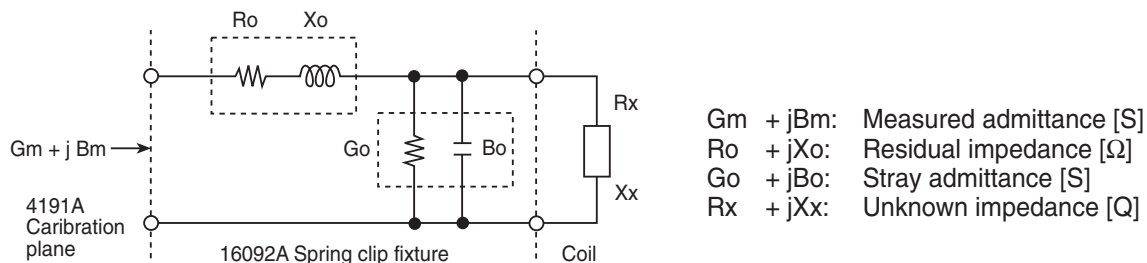

3. Set pattern up and ground side to direction mark on insulator. Measure admittance (G_m , B_m).

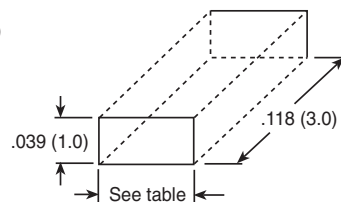
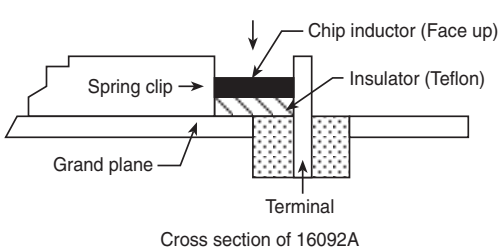

0603	.055 (1.4)
0805	.071 (1.8)
1206	.106 (2.7)

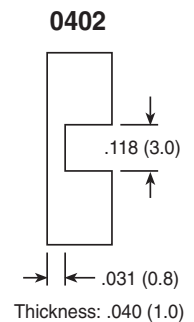

Dimensions of insulator (Teflon) in inches (mm)

4. The L and Q value shall be given the following equation. (Compensated calculation)

$$R_x = \frac{G_m - G_o}{(G_m - G_o)^2 + (B_m - B_o)^2} - R_o$$

$$X_x = \frac{B_o - B_m}{(G_m - G_o)^2 - (B_m - B_o)^2} - X_o$$

$$L = \frac{X_x}{2\pi f}, \quad Q = \frac{X_x}{R_x}$$

L: Inductance of coil
Q: Quality factor of coil
f: Measuring frequency

6-3 Characteristics

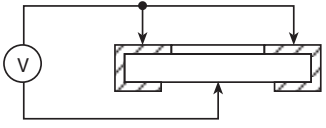
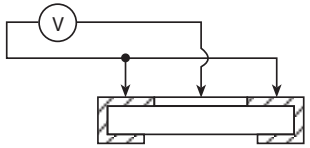
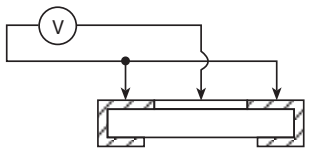
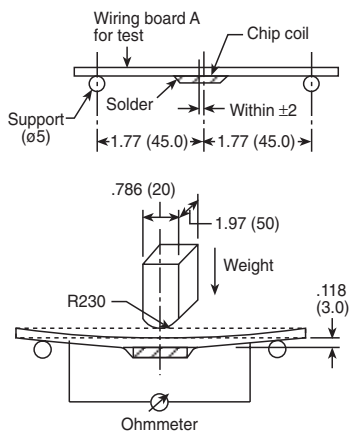
Item	Requirement	Test Method
Insulation resistance	More than 10^4 M Ω	DC 500V, 1 minute between both terminals and center of reverse side. 
	More than 10^3 M Ω	DC 500V, 1 minute Between both terminals and center of protection coating. 
Dielectric withstanding voltage	Without distinct damage	DC 500V, 1 minute Between both terminals and center of protection coating. 
Terminal strength	Δ R/R: Within $\pm 1\%$ Δ L/L: Within $\pm 2\%$ Δ Q/Q: Within $\pm 20\%$ No mechanical damage by cracks or stripping, etc.	Soldered chip on wiring board A for test is to be bent down to .079" (2 mm) - 0603, .118" (3 mm) - 0402, 0805 and 1206 as below drawing. (Set condition) Dimensions in inches (mm) 

6-3 Characteristics *Continued*

Item	Requirement	Test Method
Vibration	Δ L/L: Within $\pm 2\%$ Δ Q/Q: Within $\pm 20\%$ Without distinct damage in appearance and construction	Inflict 2 hours in each direction of X, Y, Z at vibration of JIS C 5025 (1978) type A - 0603; 10 ~ 55Hz, amplitude .059" (1.5 mm) - 0402, 0805 and 1206
Resistance to solder heat	Δ L/L: Within $\pm 2\%$ Δ Q/Q: Within $\pm 20\%$ Without distinct damage in appearance and construction	260 \pm 5°C, 10 \pm 1 second
Solderability	95% of the terminal should be covered with new solder	230 \pm 5°C, 3 \pm 0.5 second
Shock resistance	Δ L/L: Within $\pm 2\%$ Δ Q/Q: Within $\pm 20\%$ Without distinct damage in appearance and construction	Inflict the impulse 3 times to both directions (total 18 times) along perpendicular axis that test condition C of JIS C 5026 (1974) table-1 - 0603; 100G, 6 months - 0402, 0805 and 1206
Low temperature operation	Δ L/L: Within $\pm 2\%$ Δ Q/Q: Within $\pm 20\%$ Without distinct damage in appearance and construction	-40°C \pm 3°C, 1,000 \pm 4 hours
Heat resisting property	Δ L/L: Within $\pm 2\%$ Δ Q/Q: Within $\pm 20\%$ Without distinct damage in appearance and construction	125°C \pm 2°C, 1,000 \pm 4 hours
Temperature cycling	Δ L/L: Within $\pm 2\%$ Δ Q/Q: Within $\pm 20\%$ Without distinct damage in appearance and construction	-40 \pm 3°C, 30 minutes/125 \pm 2°C, 30 minutes 100 cycles
Humidity	Δ L/L: Within $\pm 2\%$ Δ Q/Q: Within $\pm 20\%$ Without distinct damage in appearance and construction. Insulation resistance: more than 50M Ω	40 \pm 2°C, 90 ~ 95% RH 1,000 \pm 4 hours
Resistance to solvent	Δ L/L: Within $\pm 2\%$ Δ Q/Q: Within $\pm 20\%$ Without distinct damage in appearance, construction and marking	Immerse 30 \pm 5 seconds in the reagent (20 ~ 25°C) of JIS K 8839 (1995)

5. Marking

5-1 Coating and Marking Color

Coating color: Dark blue
Direction mark color: Yellow

0603

Inductance value shall be indicated to two letters marking of figures and alphabet.

(Example of marking)

L1 → 1.0nH
56 → 5.6nH
10 → 10nH
H6 → 47nH

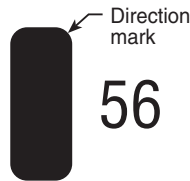

See marking item on page 2, rating table.

1206

Inductance value shall be indicated to two letters marking of significant figures. An alphabetical letter N shall replace position of decimal point.

(Example of marking)

2N2 → 2.2nH
5N6 → 5.6nH
10 → 10nH
47 → 47nH

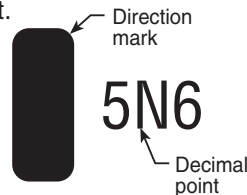

5-2 Marking Method

0402

Inductance value shall have no marking.
Direction marking only.

0805

Inductance value shall be indicated to two letters marking, including decimal point.

(Example of marking)

2.2 → 2.2nH
5.6 → 5.6nH
10 → 10nH
47 → 47nH

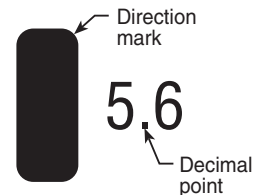

7. Packaging

7-1 Taping

The tapes for taping shall be embossed carrier tapes of .315" (8 mm) width and .157" (4 mm) pitches. The standard quantity per reel shall be 4,000 pieces. Tapes for size 0402 (only) shall be paper carrier tapes of .315" (8 mm) width and .079" (2 mm) pitches.

(1) Dimensions of carrier tape

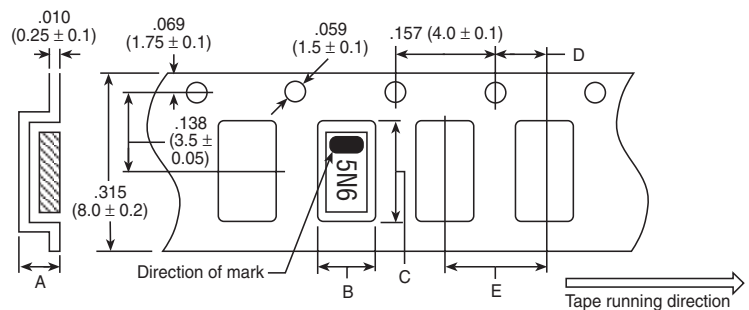

Dimensions in inches (mm)

Size	A	B	C	D	E
0402	.018 (0.45 ± 0.2)	.026 (0.65 ± 0.1)	.045 (1.15 ± 0.1)	.079 (2.0 ± 0.05)	.079 (2.0 ± 0.05)
0603	.035 (0.90 ± 0.1)	.043 (1.1 ± 0.15)	.075 (1.9 ± 0.15)	.079 (2.0 ± 0.01)	.157 (4.0 ± 0.1)
0805	.037 (0.95 ± 0.1)	.057 (1.45 ± 0.15)	.094 (2.4 ± 0.2)	.079 (2.0 ± 0.1)	.157 (4.0 ± 0.1)
1206	.037 (0.95 ± 0.1)	.074 (1.9 ± 0.2)	.137 (3.5 ± 0.2)	.079 (2.0 ± 0.1)	.157 (4.0 ± 0.1)

(2) Reel dimensions

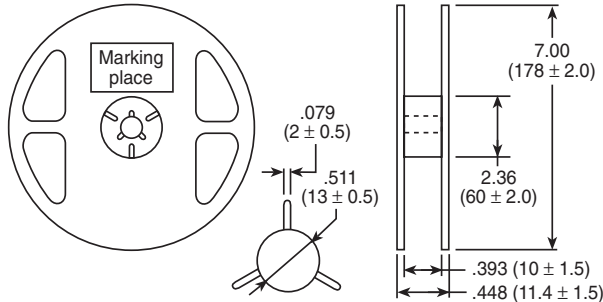
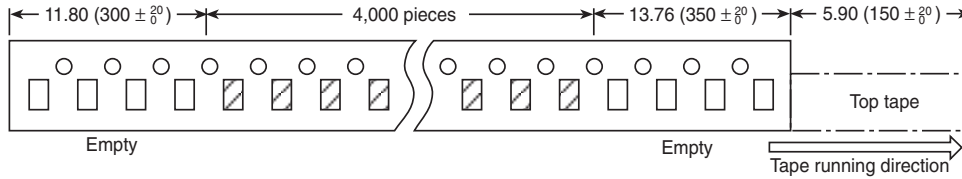

Dimensions in inches (mm)

(Marking item)

- (1) Type designation
- (2) Nominal inductance
- (3) Quantity
- (4) Production lot number
- (5) Manufacturer's name

8. Recommended Soldering Condition

Dimensions in inches (mm)

8-1 Dimensions of Standard Land

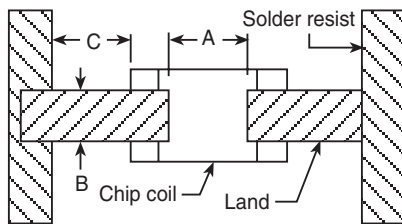

Size	A	B	C
0402 - 1E	.016 ~ .020 (0.4 ~ 0.5)	.012 ~ .020 (0.3 ~ 0.5)	.016 ~ .020 (0.4 ~ 0.5)
0603 - 1J	.031 ~ .039 (0.8 ~ 1.0)	.016 ~ .031 (0.4 ~ 0.8)	.016 ~ .031 (0.4 ~ 0.8)
0805 - 2A	.047 ~ .055 (1.2 ~ 1.4)	.035 ~ .051 (0.9 ~ 1.3)	.016 ~ .031 (0.4 ~ 0.8)
1206 - 2B	.079 ~ .094 (2.0 ~ 2.4)	.047 ~ .063 (1.2 ~ 1.6)	.016 ~ .031 (0.4 ~ 0.8)

8-2 Soldering Condition

Reflow soldering should be done at 240°C within 20 seconds. Flow soldering should be done at 260°C within 10 seconds. Please use suitable solder quantity, too much solder may affect performance of product.



9. Recommended Washing Condition

Isopropyl alcohol and methyl alcohol used for the washing process will not affect the part performance.

Ultrasonic cleaning should be changed to condition for size of printed wiring board and type of oscillator. Overpowering of ultrasonic cleaning will cause problems according to resonant phenomenon. Condition of ultrasonic cleaner should be confirmed prior to use.

We recommend the following conditions:

Ultrasonic power: Within 20W/1
Cleaning times: Within 5 minutes

10. Storage

Chip inductors should not be stored under high temperature and high humidity conditions. In particular, do not store **taping** where it is exposed to heat or direct sunlight. Otherwise, the packing material may be deformed, causing problems during mounting.